

'48-'65 Panhead models

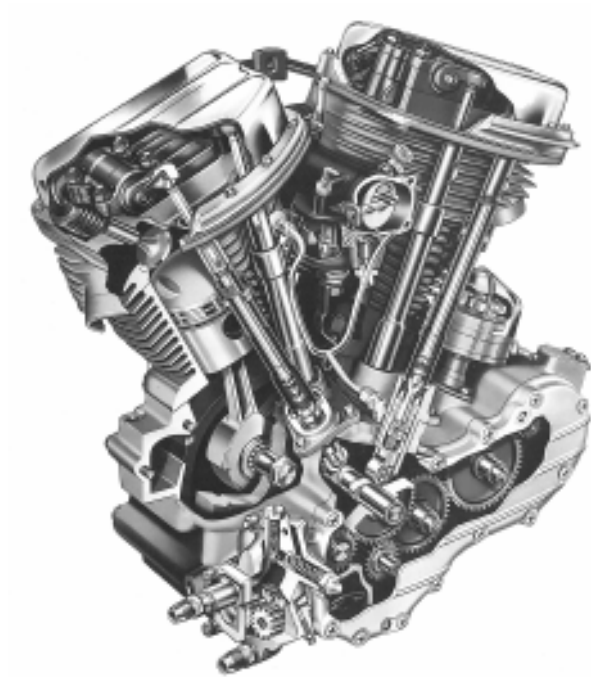

Jan Willem Boon

Meppelerweg 3
7963 RV Ruinen
The Netherlands

Phone: +31 (0)522-471177
E-mail: jw@jwboon.com
Web: www.jwboon.com

How to use this catalog:

Part number:
All numbers that begin with a letter (R, C) are reproduction parts, other numbers are original Harley parts (new old stock).

Price:
Prices are in Euro's. 
Prices include dutch sales-tax.
Sales-tax will be deducted on shipments outside the EU.
Dutch sales-tax is 21%, except books (9%).
"n.a." is "not available" (sold out)

Refers to letter in picture.
In this case you can choose between four part numbers.

A.	2326-38	Hex plug	'38-'51	park	n.a. *
"	R2326-38P	Hex plug	'38-'51	park	7.50 *
"	R2326-38	Hex plug	'38-'51	cad	7.50 *
"	R2326-38C	Hex plug	'38-'51	chrome	10.63 *
B.	C8115-1	Hex plug	'52-'73	cad	6.25 *
"	C8114-1	Hex plug	'52-'73	chrome	9.38 *

The little star * means the part was manufactured in the USA.
No star means not USA-made or we do not know. (we rely on information from our suppliers)

How to order:

You can order by phone, e-mail, or website form.

When ordering parts you need to give your name and address, and the list of part numbers you require. The part numbers are the bold printed numbers in this catalog.

You must use part numbers from this catalog, do not use Harley "oem" part numbers.

Payment and shipping depend on the size of the order, and to which country it is shipped.

You can find the cost for most common shipments on the website.

Minimum order: € 125.00

Jan Willem Boon

Meppelerweg 3
7963 RV Ruinen
The Netherlands

Phone: +31 (0)522-471177 9.00-17.00 weekdays
E-mail: jw@jwboon.com
Web: www.jwboon.com

mailorder only



Info:

Pictures in this catalog are for illustration purpose only, do not use for technical reference.

Most paper older paper gaskets need to be soaked in water for 10 minutes to regain their original size.

The Harley-Davidson part numbers are for reference only.

For up to date information check our on-line database:
www.jwboon.com

About nuts:

Early 1940's and earlier nuts were mostly manufactured by H-D and were machined from stock. These nuts are clearly different than the later style nuts.



See the "Bolts and Nuts" section in the back of this catalog for a complete list

Hex bolt head markings:

'41 and earlier bolts were usually made by Harley and were not marked (plain head). War-time production saw the arrival of other suppliers, these could be marked "1035 cp" or "1038cp"



See the "Bolts and Nuts" section in the back of this catalog for a complete list

Manuals	2	Jiffy Stand	55
Spare Parts Catalogs	2	Seat	55
Service Manuals	2	Seat Post Springs	56
Service Department Bulletins (Shop Dope)	2	Buddy Seat	57
"The Enthusiast"	3	Handlebar	58
Owner's Manuals / Riders Handbooks	3	Rear Fender	59
Accessory Catalogs	3	Front Fender	59
Miscellaneous Books	4	Chainguards	60
Upper Engine Parts	7	Rear Shock Parts	61
Hardware Kits	7	Tanks	61
Cylinder Head Bolts	8	Petrol Lines	62
Cylinder Base Studs and Nuts	8	Petrol Filters	62
Rocker Arms	9	Petrol Valve	62
Valves and Parts	11	Tool Box	63
Tappets	12	Oil Tank	64
Pistons	14	Oil Lines	65
Lower Engine Parts	16	Exhaust	66
Connecting Rod Bearing	16	Battery	67
Shafts and Parts	17	Instrument Panel	67
Motor Mounting	20	Speedometer	68
Oil Pump	25	Taillights	69
Carburetor	27	Spotlights	69
Air Cleaner	29	Horn	70
'58-'65 Generator Parts	29	Wiring	70
'32-'57 Generator Parts	30	Switches	71
Circuit Breaker (Timer)	32	Stop Light Switch	71
Spark Coils	33	Relay	71
Transmission; Starter	34	Accessories	72
Shifter	35	Sidecar Parts	72
Hardware	37	Tools	73
Main Drive Gear	39	Heli-Coil®	74
Mainshaft	40	Taps and Dies, Special Sizes	74
Countershaft	40	Taps, Dies	75
Clutch	42	Drills	75
Clutch Hub	44	Screws, Bolts, Nuts	76
Chains & Sprockets	46	Round Head Screws	76
Wheels	47	Fillister Head Screws	76
Rear Brake '37-'57	47	Oval Countersunk Head Screws	76
Rear Brake '58-'65	48	Hex Head Bolts	77
Spoke Sets	49	Nuts	78
Wheel Hub	49	Washers	79
Rear Axle	50	Lockwashers	80
Front Axle	50	Steel Balls	80
Front Brake	51	Rivets	80
Front Fork	52	Special Lockwashers	80
Rear Fork	53	Grease Fittings	80
Safety Guard	53	Cotter Pins	80
Rear Stand	53	Standard Hardware	81
Footboards	54		



Manuals

€ prices
in euro

Spare Parts Catalogs

Essential information for restoring your Harley-Davidson.
Books 500 to 503 have photos, later books have exploded views.

L500	'13-'21 Twins	95 p.	16.00 ☛
L501A	'22-'28 all except opposed Twin	90 p.	12.00
L502	'28-'32 all models	105 p.	15.00
L516	'26-'39 all models	175 p.	20.00 ☛
L503	'30-'40 Twins	150 p.	22.00
L504	'37-'49 Big Twins	148 p.	15.00
L505	'40-'50 750cc civilian and Servi-car	124 p.	15.00
L541	'40-'43 WLA military models	124 p.	15.00
L506	'49-'57 Twins incl. Servi-car	156 p.	n.a.
L508	'58-'73 Servi-car	127 p.	16.00 ☛
L507A	'54-'65 KH, XLH, XLCH	106 p.	18.00 ☛
99451-80	'79-'80 Sportster	104 p.	45.00 ☛
L498	'48-'55 Lightweight models	52 p.	16.00 ☛
L499	'56-'65 Lightweight models	62 p.	16.00 ☛
L509A	'58-'68 Panhead/Shovel	149 p.	15.00 ☛
99455-80	'71-'80 FX	233 p.	45.00 ☛
99438-80	1980 FLT	104 p.	45.00 ☛
99438-82	'80-'82 FLT	141 p.	45.00 ☛

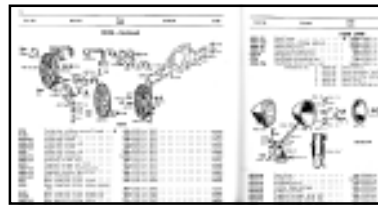

Service Manuals

L525	1928 Schebler Carburetor Manual	45 p.	16.00
L543	'41-'45 WLA Maintenance Manual	206 p.	16.00
This manual contains assembly, maintenance, organisational and test procedures for WLA or other 750cc models. Army #TM 9-879, use with overhaul manual L544 .			
L544	'41-'45 WLA Overhaul Manual	216 p.	16.00
Best manual available for all 750cc models '41-up. Army #TM 9-1879, use with L543 maintenance manual.			
L546	1942 Uncrating and Assembly	21 p.	7.50
WLA, full page photos.			
L547	1943 Motorcycle mechanics book	134 p.	20.00
WLA and XA. "The Armored School," Fort Knox.			
L548	WLC Service and operators manual	80 p.	14.00
L521	Service Manual '40-'47 Big Twins		15.00 ☛
99485-84	Sidecar Manual '79-'84 CLE/TLE		30.00 ☛
99483-80	Service Manual 1980 FLT		45.00 ☛
99483-81	Service Manual '80-'81 FLT		45.00 ☛
99498-77	Service Manual '77-'78 XLCR		85.00 ☛
L536	Service Manual '59-'66 Lightweights		17.00 ☛

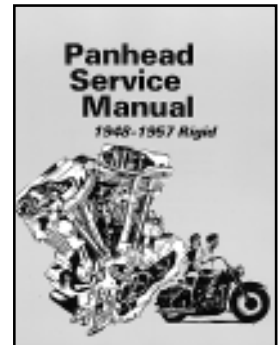

Service Department Bulletins (Shop Dope)

Collections of bulletins the factory sent to the dealers.

L530	Volume I	All models	'29-'29	18.00 ☛
L531	Volume II	All models	'30-'40	18.00 ☛
L532	Volume III	All models	'41-'56	18.00 ☛
L533	Volume IV	All models	'56-'69	27.00 ☛



prices
in euro €

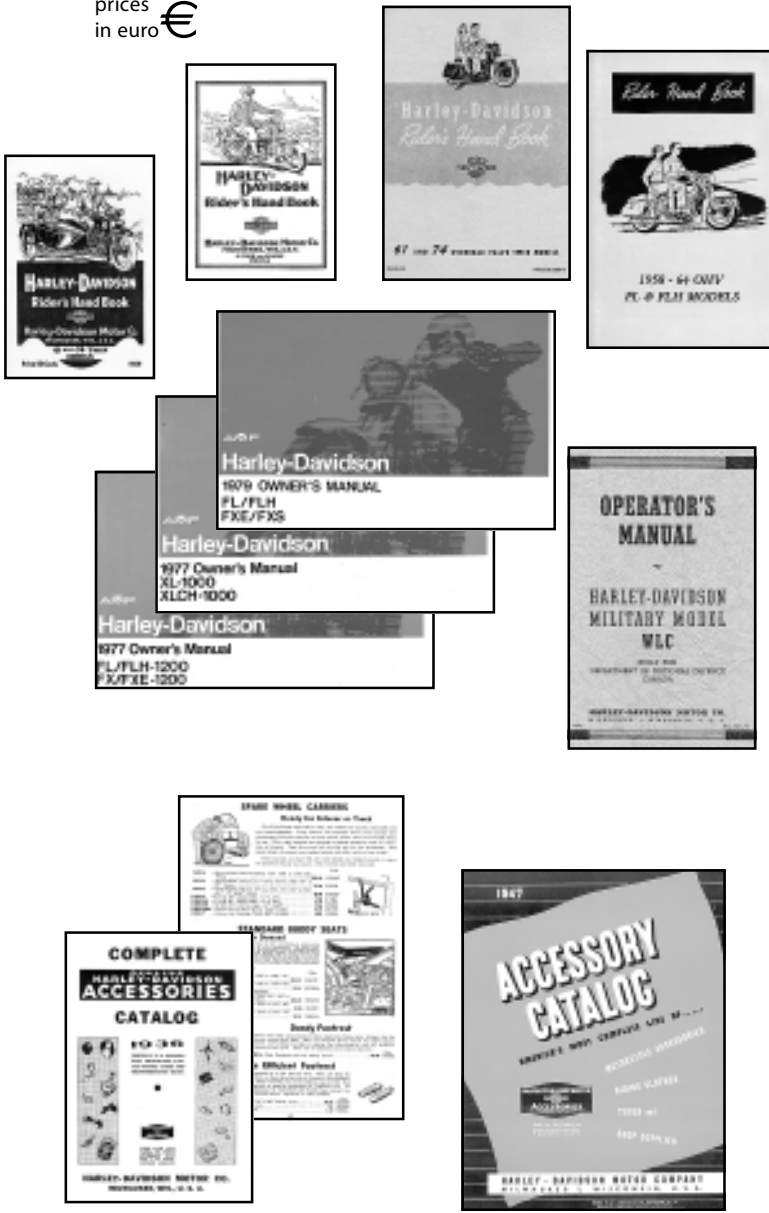

Manuals

Owner's Manuals / Riders Handbooks

Includes wiring diagram, lubricating instructions, adjustments, etc.

L561	1926	Singles	36 p.	n.a.
L562	1929	'20's Pocket-valves	63 p.	9.00
(includes supplement covering '15-'29 models)				
L563	1935	750cc (R models)	40 p.	9.00 ☉
L587	1936	VL models	40 p.	n.a.
L545	'43	WLC, also WLA and WL	36 p.	9.00
L565C	1950	Panhead	54 p.	11.00 ☉
L565A	1955	Panhead	68 p.	11.00 ☉
L565B	'58-'64	Panhead	60 p.	11.00 ☉
99460-76	1976	FL, FX	70 p.	15.00 ☉
99460-77	1977	FL, FX	72 p.	15.00 ☉
99460-78	1978	FL, FX	76 p.	15.00 ☉
99460-78E	1978½	FL, FX	80 p.	15.00 ☉
99460-79	1979	FL, FX	80 p.	15.00 ☉
99466-72	1972	Sportster	60 p.	20.00 ☉
99466-74	1974	Sportster	60 p.	17.00 ☉
99466-75	1975	Sportster	60 p.	15.00 ☉
99466-76	1976	Sportster	60 p.	15.00 ☉
99466-77	1977	Sportster	64 p.	15.00 ☉
99468-77	1977	XLCR	56 p.	20.00 ☉
99466-78	1978	Sportster	64 p.	15.00 ☉
99465-81	1981	FLT	118 p.	20.00 ☉

Accessory Catalogs

Showing all accessories available that year, including buddy-seats, saddlebags mirrors, spotlights, wind screens, lap aprons, air cleaners, clothing, hats, badges, police accessories, tools, special workshop tools, goggles, etc, etc.

L550	1918-1919	94 p.	16.00
L552	1934	32 p.	12.00 ☉
L553	1936	32 p.	9.00
L554	1941	72 p.	15.00 ☉
L555	1947	69 p.	15.00
L556	1957	60 p.	15.00 ☉
L557	1960	30 p.	15.00 ☉

"The Enthusiast"

Every year, usually late summer, the new models were announced in "The Enthusiast". Now you have an opportunity to buy the issue that announced your Harley, 1924 to 1958, barring World War II years. These Enthusiasts are also fascinating period magazines often with articles, letters and pictures from all over the world, technical hints, race reports, police department news, etc.

Quality reprints, 21½ x 14 cm., about 24 pages.

L151	1924 models	L168	1941 models
L152	1925 models	L169	1947 models
L153	1926 models	L170	1948 models
L154	1927 models	L171	not available
L155	1928 models	L172	1950 models
L156	1929 models	L173	1951 models
L157	1930 models	L174	1952 models
L158	1931 models	L175	1953 models
L159	1932 models	L176	1954 models
L160	1933 models	L177	1955 models
L161	1934 models	L178	1956 models
L162	1935 models	L179	1957 models
L163	not available	L180	not available
L164	1937 models		
L165	1938 models		
L166	1939 models		
L167	1940 models		

Military Editions

L181	October 1942
L182	not available



	1 copy	9.00 ☉
L150	6 copies	32.00 ☉
L149	12 copies	60.00 ☉

L590	1916 Sales Brochure	24 p.	n.a.
L591	1917 Sales Brochure	5 p.	3.00
L534	1950 WR/WRTT sales brochure	4 p.	7.00

Miscellaneous Books

“At The Creation”

by Herbert Wagner

For good reason the origin period of the Harley-Davidson motorcycle has been called an “era of mystery”. Not only were Harley-Davidson’s origins poorly recorded, but the company’s beginnings were further obscured by later confused and contradictory claims that developed into myths. In this work, Herbert Wagner examines several long-standing puzzles and unanswered questions. This book is the definitive account of the beginnings of the only surviving American motorcycle brand.

L686 At the creation 228 pages 45.00

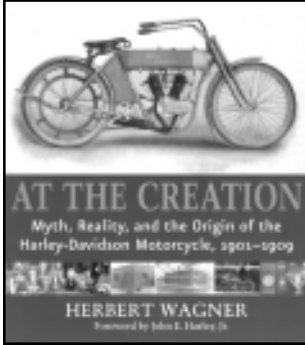

“Cross Index of Harley-Davidson Part Numbers”

Parts catalogs from 1950 and earlier use the “old” part numbers, 1951 and later parts catalogs use the “new” parts numbers.

This manual is a cross-index between the old and new numbers.

L593 Cross index of H-D part numbers 53 pages 18.00

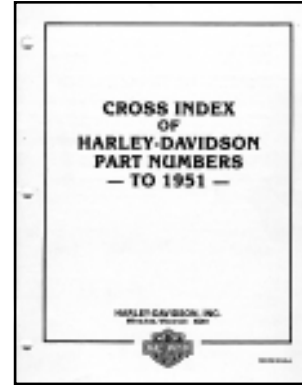

“Harley-Davidson Flatheads”

by Jerry Hatfield

One of the most versatile motorcycles ever built, the Flathead anchors the Harley-Davidson lineage. Flathead engines powered The Motor Company’s success in the 1930s when a fourth of all workers were laid off, and were the Army’s “weapon of choice” during World War II. Author Jerry Hatfield chronicles 55 years of the type’s engineering, military service, racing adventures, and sales success. Restorers will find this book indispensable, but any H-D enthusiast will enjoy this colorful fact-filled account of The Motor Company’s jack-of-all-trades, the Flathead.

L645 Flatheads 128 pages 26.00

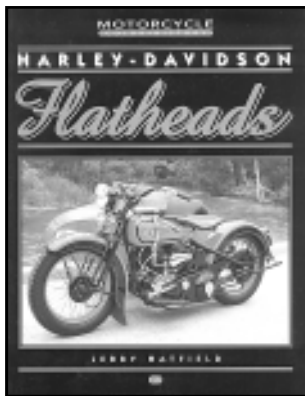

“The Big Book Of Harley-Davidson”

by Thomas C. Bolfert 1996 edition

Beautiful hard cover, full color, large size book, 10" x 12½" / 25 x 32 cm, 300 pages

Follow the trail of this American success story as it winds through history, decade by decade, influenced by wars, depressions, and severe competition from domestic and foreign sources, only to emerge in the 1990’s stronger and more popular than ever. Told in an easy narrative style, and illustrated by over a thousand colorful photos dating back to the turn of the century, the story of Harley-Davidson is fitted against a historical timeline that helps put its long past into the proper perspective of the prevailing times.

L619 Big Book of H-D 300 pages 70.00



“Growing Up Harley-Davidson”

by Jean Davidson

This memoir of the Harley-Davidson motorcycling dynasty contains rare photos from the family album, as well as the inside scoop on the behind-the-boardroom-door politics and corporate battles, adding new tales to fuel the myth behind one of the world’s great pop culture icons. All copies autographed by Jean Davidson.

L687 Growing up H-D 270 pages hard cover 20.00

L688 Growing up H-D limited edition paperback 25.00

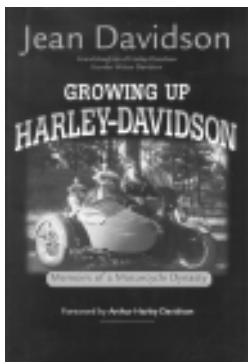

“H-D Classics 1903-1965”

-Illustrated Buyer’s Guide-
by Jerry Hatfield

Harley-Davidson was synonymous with raw power and speed in the early days of motorcycling. Those tremendous machines are chronicled here, from the early singles to the Panhead Big Twins and Sportsters. Each bike is covered year by year, with ratings for collectibility, smoothness of ride, passenger accommodations, reliability, and parts and service availability. This formidable group of data is supplanted with the author’s riding impressions, which put you in the driver’s seat of dozens of collectible Harley-Davidson motorcycles. With this comprehensive book, you’ll be well-equipped to select the year and model perfect for your needs, whether it is a 1914 Twin with sidecar, 1941 WLD, 1936 Model EL Knucklehead, or 1957 Sportster.

L639 Buyer’s Guide 1903-1965 192 pages 20.00

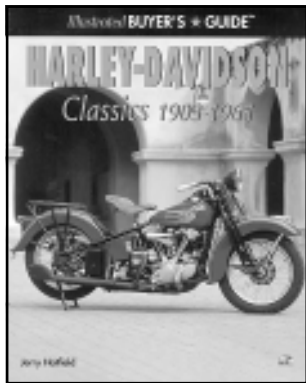

“Motorcycle Memorabilia”

by Roger Pribbenow.

Motorcycle Memorabilia is an enjoyable look at the sport of motorcycling from its beginning around 1900 to the mid-1960’s. Photographed in full color are a great variety of items illustrating the scope of memorabilia collecting and items available to the collector. From catalogs and brochures to motorcycle toys and clothing, manufacturers pins and oil containers, you’ll find it all here. Covers all American-made motorcycles.

L647 Motorcycle Memorabilia 78 pages 18.00



“Classic H-D 1903-1941”

by Herbert Wagner

Delving into the depths of Harley-Davidson history, author Herbert Wagner brings readers many new discoveries on the evolution of the Harley-Davidson Motorcycle. From the turn-of-the-century single-cylinder prototype to the 1941 74 OHV Big Twin Knucklehead, *Classic Harley-Davidson 1903-1941* captures the dream of Bill Harley and the Davidson brothers. Over 80 color photographs help illustrate this amazing story, depicting such models as: 1903 to 1905 Singles - Early V-twins, World War I military models, JDH and JH models (two-cam)- 21" and 45" OHV models - VL and VLH Flatheads - EL and FL Knuckleheads

L644 Classic H-D 1903-1941 96 pages 18.00

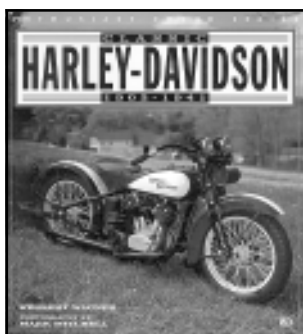

“Harley-Davidson in the 1960s”

by Allan Girdler & Jeff Hackett.

“Harley-Davidson in the 1960s” chronicles The Motor Company’s efforts to survive the Asian onslaught, a struggle that transforms Harley-Davidson-a family run business concern-into a division of AMF. In the process it tells the story of some of the most exciting motorcycles of all time. Covers all models; Duo-Glide, Early-Shovel, Sportster, KR-TT racer, Sprint, Topper scooter, etc.

L655 H-D in the 1960’s 95 pages 16.50

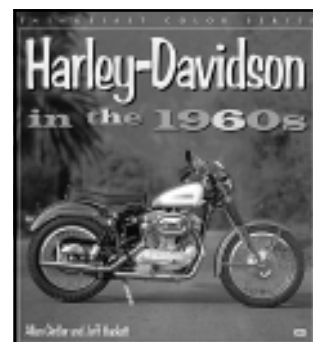

"The H-D Motor Co. - Archive Collection"

by Randy Leffingwell and Darwin Holmstrom
 Since its earliest days, the Harley-Davidson Motor Co. has saved examples of nearly every motorcycle it has ever built. In over 600 studio portraits, Harley-Davidson and master photographer Randy Leffingwell present this historically significant collection of production models, racing bikes, and one-of-a-kind prototypes.

L679 Archive Collection 408 pages 26.00



"This Old Harley"

by Michael Dregni
This Old Harley captures just what it is about Harleys that makes them so popular. This anthology is a tribute not only to this legendary piece of American automotive machinery, but also to the stories, histories, and lifestyles behind its rise as the world's most popular motorcycle.

L673 This old Harley 160 pages 26.00

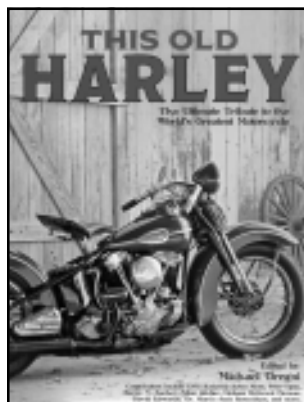

"Harley-Davidson Family Memories"

by Jean Davidson, Jon Davidson Oeflein

L676 Family Memories 168 pages hard cover 33.00

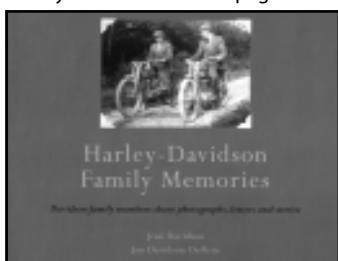

"Harley and the Davidsons"

by Pete Barnes
 A short history of the Harley-Davidson company, written for young readers.

L680 Harley and the Davidsons 106 pages 13.50

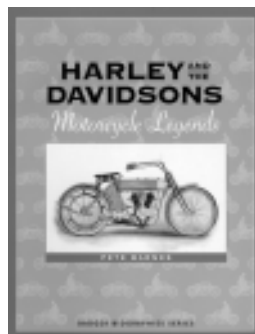

"Museum Masterpieces"

by Dain Gingerelli
 - 51 bikes featured
 - over 250 color photos
 - performance and production specs
 - historical facts and trivia about each bike

L675 240 pages 22.00

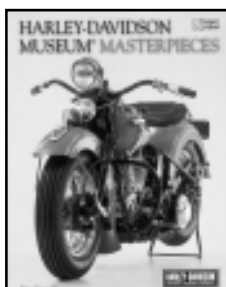

"The Harley in the Barn"

by Tom Cotter
 The Harley in the barn offers 40-plus tales of lost Nortons, hidden Harleys, dormant Indians, and busted BSA's, all squirreled away from prying eyes but found by lucky collectors just like you.

L683 256 pages hard cover 24.00



"kids Books"

by Jean Davidson

L677 "My daddy makes the best..." (autographed) 24.00
L678 "Riding back in time" (autographed) 24.00
L684 Coloring book 7.00
L685 Activity book 7.00

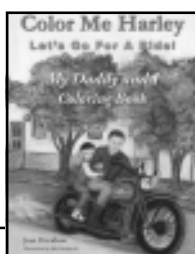
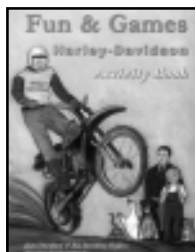

"The Encyclopedia of the Harley-Davidson"

by Peter Henshaw & Ian Kerr
 The world's most famous motorcycle manufacturer is celebrated in this comprehensive guide, from its humble beginnings to the successful company it is today.

L681 The encyclopedia of H-D 442 pages hard cover 23.00

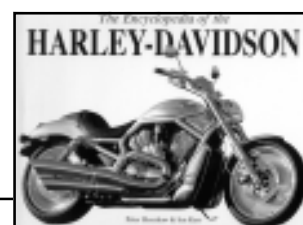

Hardware Kits

Complete engine, primary and transmission hardware kits, available in stock or acorn style.
Stock hardware kits are available cad plated or chrome plated.
Acorn head kits are available chrome plated.

Kits include head bolts, washers, cylinder base nuts, tappet guide screws, oil pump mounting nuts and bolts, gear cover screws, timing plug, drain plugs, crankcase studs and nuts, generator screws, transmission top cover screws, filler plugs, side cover nuts.

C8302CAD	Stock	'48-'57	cad	231.25 ☺
C8302CHR	Stock	'48-'57	chrome	306.25 ☺
C7907	Acorn	'48-'57	chrome	295.00 ☺
C8303CAD	Stock	'58-'65	cad	225.00 ☺
C8303CHR	Stock	'58-'65	chrome	312.50 ☺
C7908-G	Acorn	'58-'65	gold	325.00 ☺



(Pictured kit is for different model)

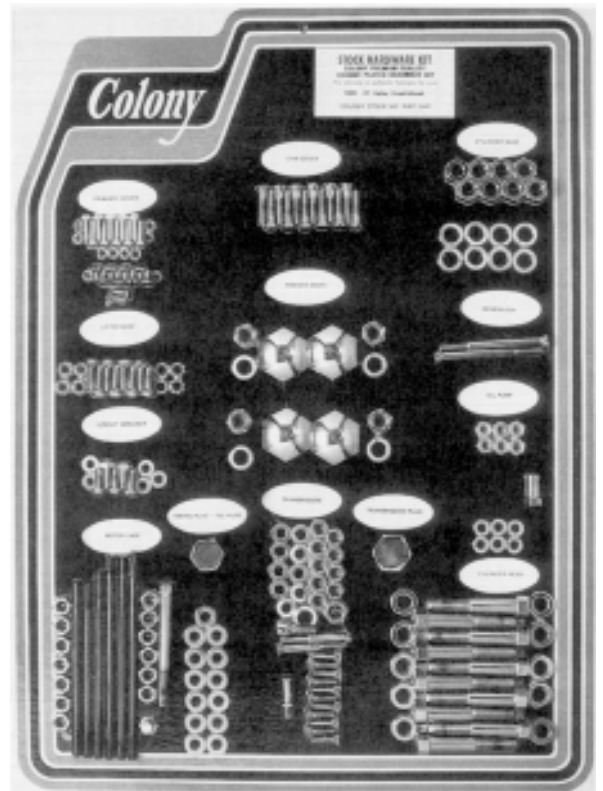

Engine Gasket Sets - James Gaskets

R51-48	Complete gasket set	'48-'65	61.00 ☺
R55-48	Top overhaul gasket set	'48-'65	40.00 ☺
R17034-48-X	Top overhaul gasket set (includes Firering head gaskets)	'48-'65	85.00 ☺

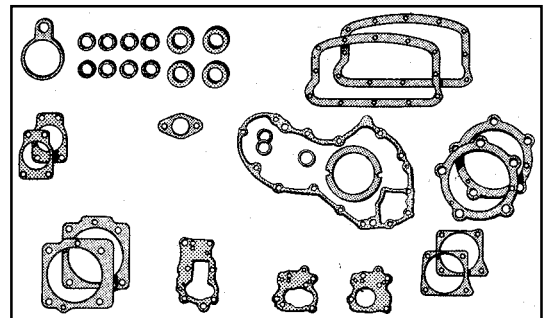

Spark Plugs

32305-48A	Spark plug	No. 2	7.00 ☺
32339-04	Spark plug	No. 3 (standard)	8.00 ☺
32337-04	Spark plug	No. 3-4	n.a. ☺
32307-58	Spark plug	No. 5	7.00 ☺



Heli-Coil® thread repair

To repair stripped 14mm spark plug hole threads.
Kit includes piloted tap, installation tool and 30 inserts.

H5523-14	Thread repair kit		165.00 ☺
HR512	Set inserts only	(6) 3/8" reach	17.50 ☺



R2341	Head holder tool	92.50 ☺
--------------	------------------	---------

Use to hold head in vise through spark plug hole (12mm and 14mm)
This tool allows you to easily position the head for all types of work.
Fits Big Twins '48-up and Sportster '57-up.



R2341

Upper Engine Parts

A.	R2806-48	Top motor mount	cad	'48-'65	n.a. ⚙ (with choke mount)
B.	16865-52	Bolt, center	black	'52-'65	7.00 ⚙
C.	0138	Castle nut	cad	'49-'65	3.20 ⚙
F.	R0234	Shim			0.75 ⚙
	C2578-4	Upper motor mount kit	'48-'51	park	12.19 ⚙
	C2650-13	Upper motor mount kit	'52-'65	park	23.75 ⚙
	C2595-13	Upper motor mount kit	'52-'65	cad	26.25 ⚙
I.	R16-48	Stud, motor brace		'48-'65	3.00
"	R16-48.10pack	10 Motor brace studs			21.00
	C2368-8	Studs, nuts and washer kit	park		21.25 ⚙
	C2369-8	Studs, nuts and washer kit	cad		21.25 ⚙

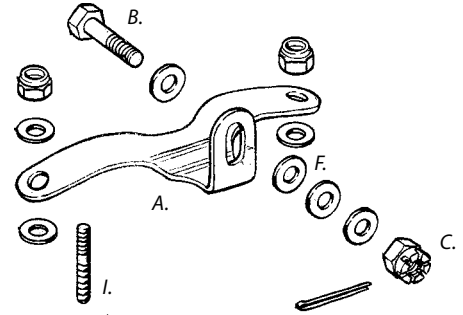

	R12-48te	Cyl. head gasket	coated paper		6.00 ⚙
	R12-48as	Cyl. head gasket	black		4.00
	R16770-48-X	Cyl. head gasket	silicone w. firering		19.50 ⚙
	34375-SL	Cylinder sleeve	1200cc / 74"		45.00 (3-7/16" x 6-5/8")

Cylinder Head Bolts

	R14-48P	Bolt	park		5.00 ⚙
	R14-48	Bolt	cad		5.00 ⚙
	R14-48C	Bolt	chrome		9.38 ⚙
	R15-36P	Washer	park		0.75 ⚙
	R15-36	Washer	cad		0.75 ⚙
	R15-36C	Washer	chrome		1.06 ⚙



Cylinder Head Bolt Kits

Kits include 10 bolts with washers.

	C2963-20	Stock	park		46.25 ⚙
	C7825-20	Stock	cad		46.25 ⚙
	C8221-20	Stock	chrome		88.75 ⚙
	C7153-20	Acorn	chrome		78.75 ⚙
	C8457-20	Cap	chrome		71.25 ⚙
	C8777-20	Allen	chrome		68.75 ⚙
	C8777-20-P	Polished Allen	chrome		76.25 ⚙
	C8170-10	Washers only	cad		7.50 ⚙
	C8488-10	Washers only	chrome		10.63 ⚙

12-point head bolt kits, these bolts give more wrench clearance.

	C8618-20	12-point	black		56.25 ⚙
	C8714-20	12-point	chrome		68.75 ⚙

Cylinder Base Studs and Nuts

M.	R29-30	Stud, cylinder base			4.81 ⚙
	C8856-8	Set cylinder base studs (8)			37.50 ⚙
N.	0134	Stock nut	park		2.00 ⚙
"	R0134P	Stock nut	park		1.69 ⚙
"	R0134	Stock nut	cad		1.81 ⚙
"	R0134C	Stock nut	chrome		3.13 ⚙
O.	R0265P	Lockwasher	park		0.69 ⚙
"	R0265	Lockwasher	zinc		0.75 ⚙
"	R0265C	Lockwasher	chrome		0.94 ⚙



Stock

Acorn

Cap

Cylinder Base Nut Kits

Kits include 8 nuts with lockwashers

	C9623-16	Stock nuts	park		17.50 ⚙
	C8105-16	Stock nuts	cad		17.50 ⚙
	C8104-16	Stock nuts	chrome		25.00 ⚙
	C7017-16	Acorn nuts	chrome		25.00 ⚙
	C8437-16	Cap nuts	chrome		26.25 ⚙
	C9716-8	Set lockwashers	park		5.38 ⚙
	C8171-8	Set lockwashers	zinc		5.63 ⚙
	C9715-8	Set lockwashers	chrome		6.63 ⚙

Big Bore Cylinder Base Nut Kits

These nuts give more wrench clearance when using big bore cylinders.

	C8601-8	Big bore base nut kit	black		33.75 ⚙
	C8600-8	Big Bore base nut kit	chrome		38.75 ⚙

Cylinder Base Gaskets

P.	16776-48	Front cylinder gasket		'48-'62	6.00 ⚙
"	R16776-48	Front cylinder gasket		'48-'62	1.30 ⚙
R.	16777-48	Rear cylinder gasket		'48-'62	5.00 ⚙
"	R16777-48	Rear cylinder gasket		'48-'62	1.30 ⚙
S.	16776-63	Front cylinder gasket		'63-'84	6.00 ⚙
"	R16776-63	Front cylinder gasket		'63-'84	1.70 ⚙
T.	16777-63	Rear cylinder gasket		'63-'84	3.00 ⚙
"	R16777-63	Rear cylinder gasket		'63-'84	1.30 ⚙

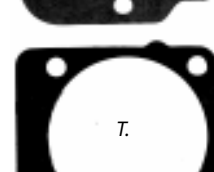
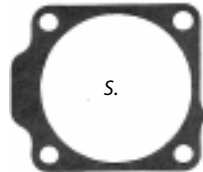
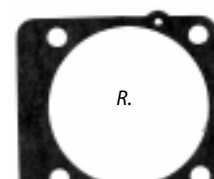
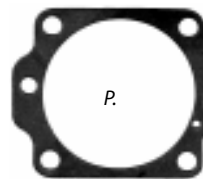

Rocker Arms

A.	R98-48	Rear exhaust & front intake		n.a.
B.	R99-48	Front exhaust & rear intake		n.a.
	R181-48	Stud, rocker arm bearing		4.94 ☺
	C9917-8	Stud set, rocker arm bearing	(8)	37.50 ☺
	C9918-8	Locknut set, bearing studs	(8)	20.63 ☺
D.	174-48	Pad, rocker arm cover	felt	6.00 ☺
"	R174-48	Pad, rocker arm cover	felt	3.00 ☺
F.	R17541-48A	Gasket, rocker cover	.062" paper	4.00 ☺
"	R17541-48B	Gasket, rocker cover	.031" paper	2.50 ☺
"	R17541-48C	Gasket, rocker cover	.125" cork	9.00 ☺
"	R17541-48D	Gasket, rocker cover	.128" paper	2.20 ☺
"	R17541-48DL	Gasket, rocker cover	molded rubber	18.00 ☺

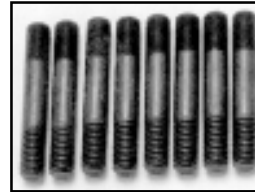
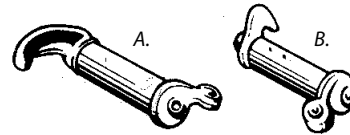

C9917-8



C9918-8

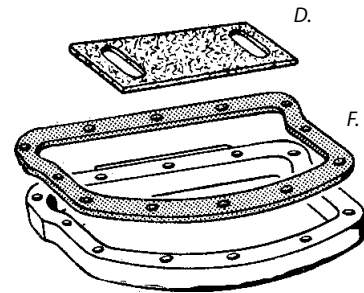

Rocker Cover Screw Kits

Kits include 24 screws, long screws are used with aluminum D-rings.
10-24 thread.

C8733-24	Hex head	long	cad	42.50 ☺
C8732-24	Hex head	long	chrome	48.75 ☺
C8735-24	Hex head	short	cad	42.50 ☺
C8734-24	Hex head	short	chrome	48.75 ☺
C8736-24	Allen head	long	chrome	29.38 ☺
C8736-24-P	Polished Allen	long	chrome	41.25 ☺
C8737-24	Allen head	short	chrome	28.13 ☺
C8737-24-P	Polished Allen	short	chrome	40.63 ☺
C7412-24	Acorn head	long	chrome	68.75 ☺
C8467-24	Cap head	long	chrome	70.00 ☺
R6150W	Washer		cad	0.30 ☺
R6150WC	Washer		chrome	1.00 ☺
C9985-24	Washer kit (24)		cad	12.50 ☺
C9984-24	Washer kit (24)		chrome	16.88 ☺
C2850-24	Stock screw kit	'51-'54		21.25 ☺

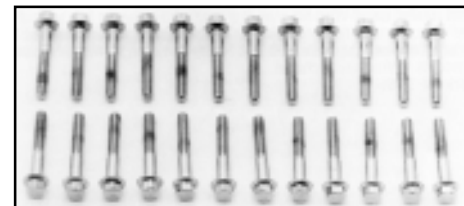

Oversize Screws

Oversize screws are 1/4"-20, sold in packs of 6.

C2014-6	Hex head	long	cad	20.63 ☺
C2013-6	Hex head	long	chrome	25.94 ☺
C2016-6	Hex head	short	cad	20.63 ☺
C2015-6	Hex head	short	chrome	25.94 ☺

M1128T	Tap 10-24 for standard size screws	n.a. ☺
M8125D	Drill #25 (correct size for 10-24 tap)	n.a. ☺
M1420T	Tap 1/4"-20 for oversize screws	n.a. ☺
M8107D	Drill #7 (correct size for 1/4"-20 tap)	4.00 ☺



Heli-Coil® thread repair

H5521-3	Heli-coil repair kit	10-24	56.00 ☺
HR1185-3	Set Heli-coil inserts only	(12)	21.00 ☺
M6113D	Drill 13/64", use with kit		n.a. ☺



Upper Engine Parts

Pushrods

These lightweight pushrods are manufactured from the best materials available. Aircraft grade aluminum tubing and heat treated steel ends provide maximum durability and long life expectancy.

Non-adjustable pushrods, use with adjustable solid tappets.

C7519-4	Pushrod kit	1000cc	'48-'65	61.25	✚
C7122-4	Pushrod kit	1200cc	'48-'65	61.25	✚
C7506-4	Panhead using Shovel top end			60.00	✚

Stock replacement pushrods.

C7515-4	Pushrod kit, adjustable	(4)	'53-'65	75.00	✚
----------------	-------------------------	-----	---------	-------	---

Solid tappet conversion kit, replaces stock rods and hydraulic units.

C7131-12	Pushrod converter kit		'53-'65	92.50	✚
C8204-4	Converters only	set of 4		40.00	✚

Note: solid converters can also be used with stock pushrods, easiest way to convert to solid tappets.

C3056-1	Pushrod lifter tool			95.00	✚
----------------	---------------------	--	--	-------	---

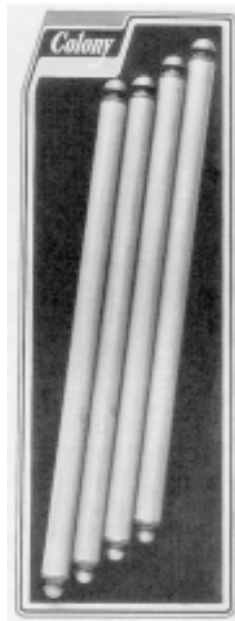

C7519-4



C7131-12



Adjustable pushrod locknuts, sets of 4

C8780-4	Fits tappets/pushrods	9/32"-32	10.00	✚
18556-57	Screw, pushrod adjusting	9/32"-32	21.00	✚ (with nut)
R18556-57	Screw, pushrod adjusting	9/32"-32	5.00	✚ (without nut)

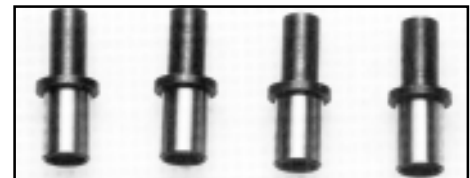

C8204-4



C8780-4



18556-57

Pushrod Covers

C7823-12	Lower cover kit	chrome	71.25	✚
C7135-8	Lower cover kit	custom chrome	70.00	✚
C7507-20	Upper cover kit	chrome	57.50	✚
C7808-4	Inner pushrod cover kit		36.25	✚
C8728-12	Pushrod cover seal kit	rubberized cork	10.63	✚
C3170-12	Pushrod cover seal kit	rubber	8.13	✚
R140-36	Spring, push rod cover	'36-'84	1.20	✚
R140-36.10pack	10 Springs	'36-'84	9.00	✚
R145-36	Washer, push rod cover	cork	0.50	✚
R145-36.10pack	10 Cork washers		4.00	✚
R145-48	Washer, push rod cover, lower	cork	0.50	✚
R145-48.10pack	10 Lower cork washers		4.00	✚
R146-36	Steel washer, cover	.030" thick	0.70	✚

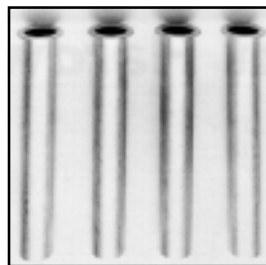

C7808-4

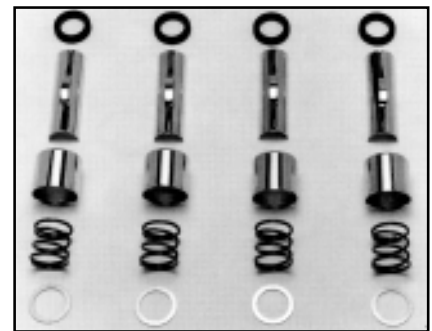

C7507-20



R140-36



R146-36

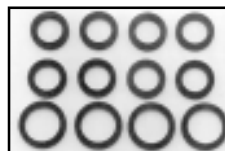

C8728-12

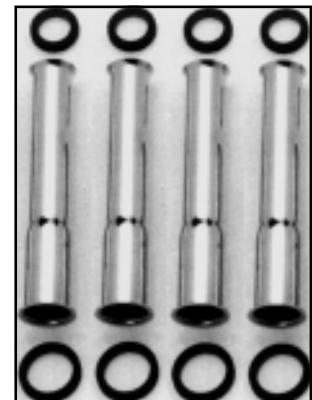

C7823-12



C7135-8



Valves and Parts

A.	R163-48	Valve, inlet	'48-'65	15.00
"	R163-48rowe	Valve, inlet Rowe	'48-'65	20.00 ☼
"	R163-48rochr	Valve, inlet hard-chromed	'48-'65	20.00 ☼
"	R163-48-1	Valve, inlet 1/8" oversize	'48-'65	16.00
"	R163-48N-1	Valve, inlet 1/8" oversize	black nitrided	18.00
B.	R18082-57	Valve, exhaust	'48-'65	16.00
"	R18086-80	Valve, exhaust	black nitrided	17.00
"	R18082-57-1	Valve, exhaust 1/8" oversize	'48-'65	19.00
"	R18082-57N-1	Valve, exhaust 1/8" oversize	black nitrided	21.00
"	18082-60	Valve, exhaust 0.156" oversize head		75.00 ☼
"	162-48	Insert, valve seat		35.00 ☼
C.	R170-36	Collar, upper		6.50 ☼
"	R170-36.4pack	4 Upper collars		22.00 ☼
D.	172-36	Keys, valve collar (2)		5.00 ☼
"	R172-36	Keys, valve collar (2)		3.00 ☼
E.	171-48	Collar, lower	'48-'79	8.00 ☼
"	171-48.10pack	10 Lower collars	'48-'79	65.00 ☼
"	R171-48	Collar, lower	'48-'79	6.50 ☼
"	R18196-51	Gasket, valve guide	'51-'79	0.40
"	R18196-51.10pack	10 Valve guide gaskets		2.50
"	R18201-57B	Valve spring set (8)	'48-'65	44.00 ☼

Complete valve spring kit, includes springs, collars, keepers.
15-0028 Valve spring kit '48-'79 75.00 ☼

R18181-48	Guide, exhaust	O.D.	0.566"	9.00
R18181-48.01	Guide, exhaust	oversize	+ .001"	9.00
R18181-48.03	Guide, exhaust	oversize	+ .003"	9.00
R18181-48.04	Guide, exhaust	oversize	+ .004"	9.00
R18181-48.06	Guide, exhaust	oversize	+ .006"	9.00
R18181-48.08	Guide, exhaust	oversize	+ .008"	9.00
R18181-48.10	Guide, exhaust	oversize	+ .010"	9.00
R18185-48	Guide, inlet	O.D.	0.566"	9.00
R18185-48.02	Guide, inlet	oversize	+ .002"	9.00
R18185-48.04	Guide, inlet	oversize	+ .004"	n.a.
R18185-48.06	Guide, inlet	oversize	+ .006"	9.00
R18185-48.08	Guide, inlet	oversize	+ .008"	9.00
R18185-48.10	Guide, inlet	oversize	+ .010"	9.00
R18185-48.12	Guide, inlet	oversize	+ .012"	9.00
R18185-48.20	Guide, inlet	oversize	+ .020"	9.00

Valve guide drivers, use for guide removal and installation.

R1001-1	Driver	.370"	3/8"	35.00 ☼
R1001-2	Driver	.338"	11/32"	35.00 ☼
R1001-3	Driver	.307"	5/16"	35.00 ☼
R1001	3 sizes in one set			65.00 ☼

- 3/8" driver can be used for 1200cc Flathead, Knuckle, Pan, Shovel, etc.
- Set also includes drivers for 750cc and Sportster.

R96600-36B Valve spring compressor 275.00 ☼

R1060 Valve spring seat cutter '48-'84 135.00 ☼
Carbide cutting tips. Use this tool to lower spring seats for high lift cams.
Cuts spring seats to 1.630" O.D., 0.635" I.D.
(must be used with arbor **R1062**)

R1062 Arbor, spring seat cutter '48-'84 35.00 ☼

R1064 Valve guide cutter '48-'84 n.a. ☼
Cuts valve guides to 0.531" O.D. to use teflon valve stem seals.
Carbide cutting tips, arbor included.

R1090 Mini valve spring tester 0-600 psi 210.00 ☼
Hex design for more versatile handling and applications.
Can be used in vise, arbor, or drill press. Cylinder body and piston are manufactured from 2024 aluminum and a steel perch to provide years of service. Includes instructions. Protective rubber gauge boot reduces shock to gauge during handling and use.

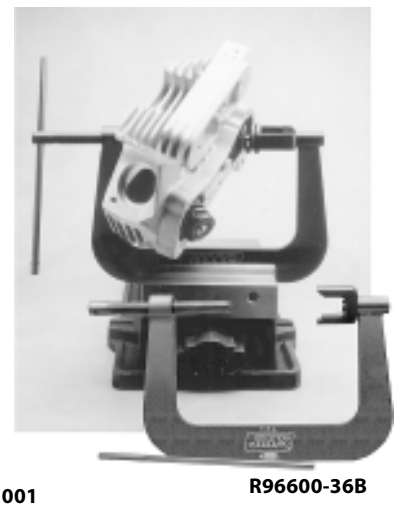
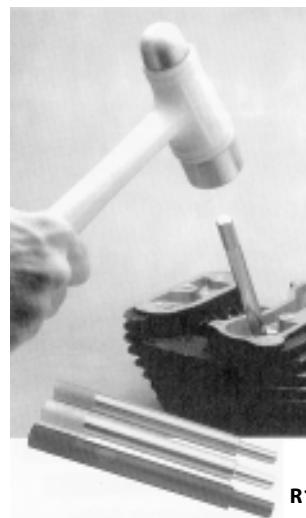
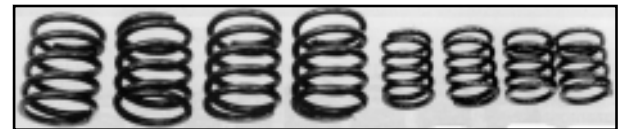
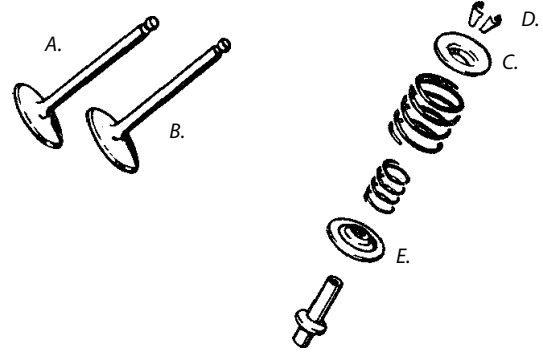

Upper Engine Parts

Tappets

Hydraulic tappet assembly

'53-'84 (does not include hydraulic unit)

Eastern Parts, made in U.S.A.

R18522-53A	Tappet	standard	O.D.	0.730"	✚
R18522-78A	Tappet	oversize		+0.005"	✚
R18522-79	Tappet	oversize		+0.010"	✚
R18522-80	Tappet	oversize		+0.015"	✚
R18522-90	Tappet	oversize		+0.020"	✚
R18522-91	Tappet	oversize		+0.025"	58.00 ✚
R18522-92	Tappet	oversize		+0.030"	59.00 ✚
R18522-93	Tappet	oversize		+0.035"	64.00 ✚
R18522-94	Tappet	oversize		+0.040"	65.00 ✚

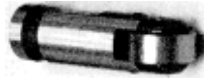

Solid tappet assembly

With screw and nut '48-'84, use with non-adjustable pushrods.

R18492-48	Tappet	standard	O.D.	0.730"	
R18492-78	Tappet	oversize		+0.005"	
R18492-48.010	Tappet	oversize		+0.010"	40.00
R18492-80	Tappet	oversize		+0.015"	

Jims Hydraulic Tappets

'53-'84.

R18522-53Ajims	Tappet	standard	O.D.	0.731"	110.00 ✚
R18522-53Ajims.002		oversize		+0.005"	115.00 ✚
R18522-53Ajims.005		oversize		+0.005"	115.00 ✚



Jims Solid Tappets

'48-'84, includes screw and nut, use with non-adjustable pushrods.

R18493-48S	Tappet	standard	O.D.	0.731"	128.50 ✚
R18493-48S.002	Tappet	oversize		+0.002"	135.00 ✚
R18493-48S.005	Tappet	oversize		+0.005"	135.00 ✚



Jims Powerglide Tappets

'53-'84, includes hydraulic unit.

R18523-53P	Tappet	standard	O.D.	0.731"	160.00 ✚
R18523-53P.002	Tappet	oversize		+0.002"	167.50 ✚
R18523-53P.005	Tappet	oversize		+0.005"	167.50 ✚



Tappet Parts

A.	R208-29	Tappet roller, with pin		10.00 ✚
	R208-29set	Set tappet roller kits (4)		34.00 ✚
B.	R214-29	Pin, tappet roller		0.60 ✚
C.	R221-36A	Screw, adjustable tappets, with nut		4.50
D.	223-38	Nut, tappet screw		3.50 ✚
"	R223-38	Nut, tappet screw		1.50
"	R18570-78	Nut, tappet screw (flat top)		2.00 ✚
		(special nut used with some tappets)		



Tappet Guides



Made from 7075-T651 aluminum with a tensile strength of 83,000 PSI which is double the amount of 6061-T6 aluminum and almost triple the amount of cast aluminum tappet blocks. These tappet blocks are machined to the center line of the cam and hold to ±.002". Also, the bores are held perpendicular to the mounting flange to ±.0002". Pushrod cover angles have been optimized for a leak tight seal. Designed to accommodate .550" lift at the valves, blocks can be cleared for a higher lift cam with simple modification. Use with flat screws, not countersunk.

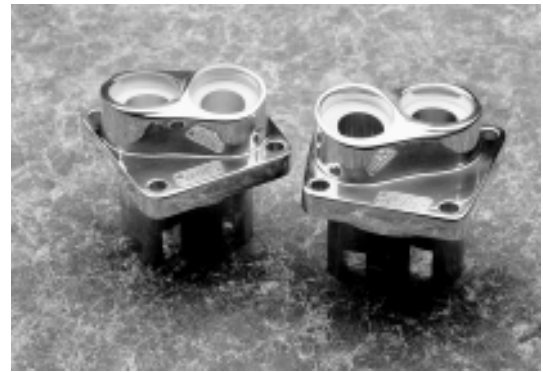

R1095	Set tappet guides, polished	'53-'84	650.00 ☼
R237-48	Gasket, tappet guide, rear	'48-'84	1.00 ☼
R237-48.10pack	10 Rear gaskets	'48-'84	7.00 ☼
R237-48A	Gasket, tappet guide, front	'48-'84	1.00 ☼
R237-48A.10pack	10 Front gaskets	'48-'84	7.00 ☼



Tappet Guide Screws

'30-'53 slotted head

R057P	Screw, slotted head	park	1.56 ☼
R057	Screw, slotted head	cad	1.56 ☼
R057C	Screw, slotted head	chrome	2.19 ☼
R0365P	Lockwasher	park	0.38 ☼
R0365	Lockwasher	zinc	0.25 ☼



Tappet Guide Screw Kits

Kits include 8 screws.

Countersunk screws, 1/4"-24 thread, stock

C9622-16	Kit, slotted head screws	'48-'53 park	14.38 ☼
C8103-16	Kit, slotted head screws	'48-'53 cad	15.00 ☼
C8102-16	Kit, slotted head screws	'48-'53 chrome	18.75 ☼
C2100-16	Kit, Phillips head screws	'50-'53 cad	16.56 ☼
C2099-16	Kit, Phillips head screws	'50-'53 chrome	19.38 ☼
C8605-16	Kit, hex head screws	'54-'75 cad	21.25 ☼
C8604-16	Kit, hex head screws	'54-'75 chrome	23.75 ☼



Slotted



Acorn

Countersunk screws, 1/4"-24 thread, custom

C7131-8	Kit, acorn head screws	'48-'75 chrome	30.00 ☼
C8447-8	Kit, cap head screws	'48-'75 chrome	30.63 ☼
C8760-16	Kit, Allen head screws	'48-'75 chrome	19.38 ☼



Cap



12-point

Countersunk screws, 1/4"-20 thread

Aftermarket crankcases usually have 1/4"-20 thread

C9816-16	Kit, slotted head screws	'48-'75 park	14.38 ☼
C9815-16	Kit, slotted head screws	'48-'75 cad	14.38 ☼
C9814-16	Kit, slotted head screws	'48-'75 chrome	16.25 ☼
C9828-16	Kit, Allen head screws	'48-'75 chrome	19.38 ☼

Flat screws, 1/4"-24 thread

For late style or aftermarket tappet guides.

C8480-8	Kit, acorn head screws	chrome	32.50 ☼
C8490-8	Kit, cap head screws	chrome	32.50 ☼
C8727-8	Kit, Allen head screws	chrome	16.88 ☼
C8713-8	Kit, 12-point screws	black	13.13 ☼
C8712-8	Kit, 12-point screws	cad	13.13 ☼
C8711-8	Kit, 12-point screws	chrome	15.00 ☼



Flat screws, 1/4"-20 thread

Stock on '76-up models, also when using aftermarket crankcases and tappet guides.

C7628-8	Kit, acorn head screws	chrome	30.63 ☼
C8470-8	Kit, cap head screws	chrome	33.75 ☼
C8710-8	Kit, 12-point screws	black	13.13 ☼
C8709-8	Kit, 12-point screws	cad	13.13 ☼
C8708-8	Kit, 12-point screws	chrome	15.00 ☼
C8726-8	Kit, knurled Allen screws	chrome	13.75 ☼
C8726-8-P	Kit, polished Allen screws	chrome	16.25 ☼

Heli-Coil® thread repair

H5540-4	Heli-coil repair kit	1/4"-24	125.00 ☼
HR389-4	Set Heli-coil inserts only	(12)	25.00 ☼
M6117D	Drill 17/64", use with kit		n.a. ☼
H5521-4	Heli-coil repair kit	1/4"-20	43.00 ☼
HR1185-4	Set Heli-coil inserts only	(12)	21.00 ☼
M6117D	Drill 17/64", use with kit		n.a. ☼



Upper Engine Parts

1000cc Pistons

Pistons are sold each, without rings:

- piston pin with split ring type keepers (**280-32**)
(install with tool **R96780-32A**)



R256-36	Piston, without rings	Std.	n.a.
R256-36D	Piston, without rings	+0.010"	n.a.
R256-36E	Piston, without rings	+0.020"	40.00
R256-36F	Piston, without rings	+0.030"	40.00
R256-36G	Piston, without rings	+0.040"	40.00
R256-36H	Piston, without rings	+0.050"	40.00
R256-36JA	Piston, without rings	+0.060"	40.00
R256-36KA	Piston, without rings	+0.070"	40.00
R256-36MA	Piston, without rings	+0.080"	40.00
R256-36Q	Piston, without rings	+0.090"	40.00
R256-36R	Piston, without rings	+0.100"	40.00

1200cc Pistons

FL Pistons (standard compression)

Pistons are sold each and include:

- 1/16" compression rings,
3/16" oil ring (3-piece)

- piston pin with late style keepers
(R22588-78)



22101-53TC	Piston	Standard	3.4:	
22103-53C	Piston	O.S.	+0	
22103-53TD	Piston	O.S.	+0.010"	75.00
22104-53D	Piston	O.S.	+0.020"	80.00 ☼
22104-53TD	Piston	O.S.	+0.020"	75.00
22105-53C	Piston	O.S.	+0.030"	80.00 ☼
22105-53TD	Piston	O.S.	+0.030"	75.00
22106-53D	Piston	O.S.	+0.040"	80.00 ☼

Check website for availability

1000cc Piston Rings

- Set is for two pistons - 3/32" compression rings, 3/16" oil rings

PR11224R-000	Ring set, 1-piece oil rings	Std.	28.50
PRP11224R-000	Ring set, 3-piece oil rings	Std.	26.50
PRP11224R-010	Ring set, 3-piece oil rings	+0.010"	26.50
PR11224R-020	Ring set, 1-piece oil rings	+0.020"	28.50
PRP11224R-020	Ring set, 3-piece oil rings	+0.020"	26.50
PR11224R-040	Ring set, 1-piece oil rings	+0.040"	28.50
PRP11224R-040	Ring set, 3-piece oil rings	+0.040"	26.50
PR11224R-050	Ring set, 1-piece oil rings	+0.050"	28.50
PRP11224R-050	Ring set, 3-piece oil rings	+0.050"	26.50
PR11224R-060	Ring set, 1-piece oil rings	+0.060"	28.50
PRP11224R-060	Ring set, 3-piece oil rings	+0.060"	26.50
PR11224R-070	Ring set, 1-piece oil rings	+0.070"	28.50
PR11224R-080	Ring set, 1-piece oil rings	+0.080"	28.50
PRP11224R-080	Ring set, 3-piece oil rings	+0.080"	26.50
PR11224R-090	Ring set, 1-piece oil rings	+0.090"	28.50

1200cc Piston Rings

Set is for two pistons (6 rings) -1/16" compression rings, 3/16" oil rings

R22325-55	Ring set	standard		18.00
R22327-55	Ring set	oversize	+0.010"	18.00
R22328-55	Ring set	oversize	+0.020"	18.00
R22329-55	Ring set	oversize	+0.030"	18.00
R22330-55	Ring set	oversize	+0.040"	18.00
R22331-55	Ring set	oversize	+0.050"	18.00
R22332-55B	Ring set	oversize	+0.060"	17.00
R22335-78A	Ring set	oversize	+0.070"	17.00
R22336-78A	Ring set	oversize	+0.080"	17.00
R22336-78AP090	Ring set	oversize	+0.090"	17.00
R22336-78AP100	Ring set	oversize	+0.100"	17.00

Genuine Pistons, FLH '55-'73, FX '71-'73

22141-55B	Piston	Standard	
22143-55B	Piston	Oversize	+0.010"
22145-55B	Piston	Oversize	+0.030"
22146-55B	Piston	Oversize	+0.040"
- 22147-55B	Piston	Oversize	+0.050"
22148-55B	Piston	Oversize	+0.060"
22149-55B	Piston	Oversize	+0.070"

Check website for availability

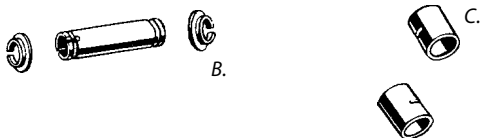

B. 280-32	Lockring, piston pin split ring type		5.00 ☼
" R280-32	Lockring, piston pin split ring type		2.50
R22588-78	Lockring, piston pin late style		0.40
C. R295-36	Piston pin bushing Std. O.D.	0.896"	4.00 ☼
" R295-36B	Piston pin bushing O.S.	+0.005"	n.a. ☼
" R295-36C	Piston pin bushing O.S.	+0.010"	3.50 ☼



R96780-32A



R96780-58A

R96780-32A Piston pin lock ring tool 74.50 €
Use with **280-32** locks.

R96780-58A Piston pin lock ring tool 190.00 €
(piston pin I.D. .515")

R96781-72 Piston pin lock ring tool 190.00 €
(piston pin I.D. .535")
Use with **22582-52** expanding ring type locks.



R1010 Rod alignment tool 41.00 €
Use to check rod straightness when rods are installed.



R1236 Piston ring compressor set 132.50 €
Supplied with 6 bands ranging from 2-3/16" to 4-3/8" (does not fit 750cc models). Fine tooth ratcheting motion to compress bands in small increments for accurate compression. (will not break or damage rings)



R95970-32C

R95970-32C Piston pin bushing tool 185.00 €
Use to replace bushings without removing rods.



R1235 Piston ring expander tool 38.50 €
Remove and install rings without fear of breakage. Smooth gripping edges firmly hold rings to eliminate possible ring damage. Expands rings gently to install in grooves.





Lower Engine Parts

Connecting Rods

R24281-41A Set of connecting rods 1200cc 125.00
With bearing and crank pin. For 1000cc motors change crank pin.

CRR-36A Set extra strong races 52100 bearing steel 97.50 

CRR-BT Set of connecting rod races (3) 25.00 

CRR-BT.001 Set of connecting rod races (3) +.001" 28.00 







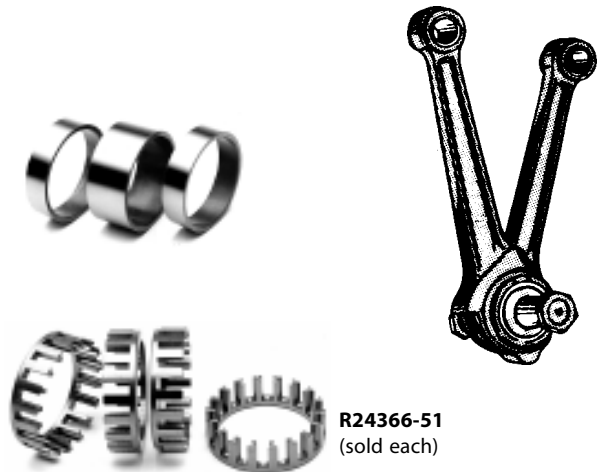











CRR-BT.002 Set of connecting rod races (3) +.002" 28.00 

CRR-BT.005 Set of connecting rod races (3) +.005" 28.00 

CRR-BT.010 Set of connecting rod races (3) +.010" 28.00 



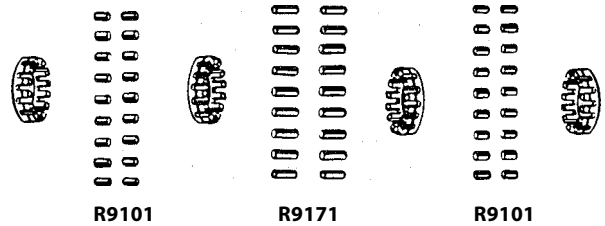

R24366-51 Retainer, crank pin roller, steel (each) 62.50 

Roller, short 0.329"			Roller, long 0.662"		
R9101	Std. 0.1875"	0.40 	R9171	Std. 0.1875"	0.40 
R9102	+.0002"	0.40 	R9172	+.0002"	0.40 
R9103	+.0004"	0.40 	R9173	+.0004"	0.40 
R9104	+.0006"	0.40 	R9174	+.0006"	0.40 
R9105	+.0008"	0.40 	R9175	+.0008"	0.40 
R9106	+.0010"	0.40 	R9176	+.0010"	0.40 
R9106+2	+.0020"	0.40 	R9176+2	+.0020"	0.40 
R9106+3	+.0030"	0.40 	R9176+3	+.0030"	0.40 
R9108	-.0002"	0.40 	R9179A	-.0002"	0.40 





Bearings are '51-'72 style with steel retainers.

R24385-40A Bearing, connecting rod standard 235.00 

R24386-40A Bearing, connecting rod +.0002" 235.00 

R24387-40A Bearing, connecting rod +.0004" 235.00 

R24388-40A Bearing, connecting rod +.0006" 235.00 

R24389-40A Bearing, connecting rod +.0008" 235.00 

R24390-40A Bearing, connecting rod +.0010" 235.00 

R24391-40A Bearing, connecting rod -.0002" 235.00 





Bearings are '73-later style with aluminum retainers.

R24385-40B Bearing, connecting rod standard 45.00 

R24386-40B Bearing, connecting rod +.0002" 45.00 

R24387-40B Bearing, connecting rod +.0004" 45.00 

R24388-40B Bearing, connecting rod +.0006" 45.00 

R24389-40B Bearing, connecting rod +.0008" 45.00 

R24390-40B Bearing, connecting rod +.0010" 45.00 

R24391-40B Bearing, connecting rod -.0002" 45.00 



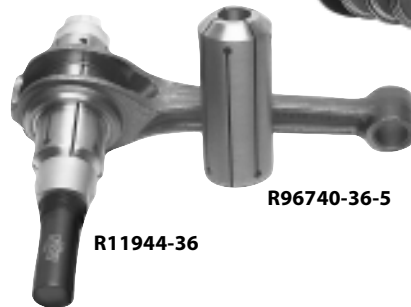

R1003 Rod race removal & installation tool 285.00 

Complete kit, includes collars for use on all Big Twin, 750cc and Sportster connecting rods.



R11944-36 Connecting rod lapping arbor 357.50 

R96740-36-5 Lap head only, 1-5/8" 180.00 

R96740-36 Connecting rod lapping set 537.50 

Includes 1-1/2" and 1-5/8" lap heads.



R1034 Sprocket shaft holder '55-up 170.00 

Use to hold the flywheel assembly in vise, with or without left crankcase.



Shafts and Parts

JIMS	A.	R348-40	Crank pin	1000cc	1.249"	149.50	⊕
	B.	348-41	Crank pin	1200cc 1 hole	1.249"	115.00	⊕ (NOS)
	"	R348-41	Crank pin	1200cc 1 hole	1.249"	44.00	⊕ (japan)
JIMS	"	R348-41.0H1	Crank pin	1200cc 1 hole	1.249"	134.50	⊕
JIMS	"	R348-41.0H2	Crank pin	1200cc 2 hole	1.249"	134.50	⊕
JIMS	C.	R348-41.0H3	Crank pin	1200cc 3 hole	1.249"	134.50	⊕
JIMS	"	R348-41S	Crank pin	1200cc 3 hole, 180° design		138.50	⊕
JIMS	D.	R352-30	Sprocket shaft		'30-'54	100.00	⊕
	E.	R24001-55	Sprocket shaft		1955	95.00	⊕
JIMS	"	R24001-55jims	Sprocket shaft		1955	98.00	⊕
JIMS	F.	R24001-56jims	Sprocket shaft		'56-'64	90.00	⊕
	G.	24001-65	Sprocket shaft		'65-'69	145.00	⊕
	"	R24001-65	Sprocket shaft		'65-'69	85.00	⊕
JIMS	"	R24001-65jims	Sprocket shaft		'65-'69	145.00	⊕
Special sprocket shafts							
		R24001-80SP	'56-'64 with '72-'81 flywheels			110.00	⊕
		R24001-81SP	'65-'69 with '72-'81 flywheels			110.00	⊕
		R24001-84SP	'56-'64 with '81-'86 flywheels			110.00	⊕
		R24001-86SP	'65-'69 with '81-'86 flywheels			110.00	⊕
JIMS	H.	R356-39	Gear shaft		'39-'53	175.00	⊕
	I.	R24006-54A	Gear shaft		'54-'57	95.00	⊕
JIMS	"	R24006-54Ajims	Gear shaft		'54-'57	155.00	⊕
JIMS	J.	R24006-58jims	Gear shaft		'58-'72	145.00	⊕
		24020-51	Screw, left hand thread		'51-'53	3.50	⊕
(fits original '51-'53 gear shaft and above R356-39 gear shaft)							



A.

JIMS

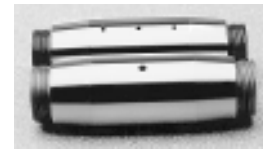

C.

JIMS

B.

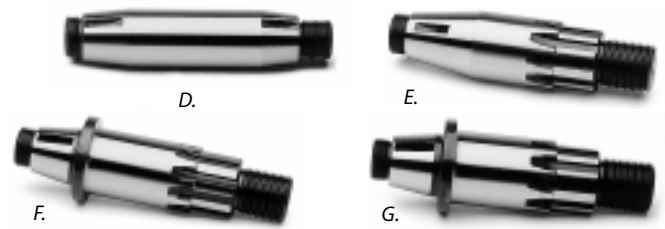

D.

E.

F.

G.

1650-18	Key, crank pin	'48-'81	2.00	⊕
R1650-18	Key, crank pin	'48-'81	0.40	
R361-12	Key, sprocket shaft	'48-'55	2.75	⊕
23985-56	Key, sprocket shaft	'56-'71	2.50	⊕
R23985-56	Key, sprocket shaft	'56-'71	1.10	⊕

R361-12	Key, gear shaft	'48-'81	2.75	⊕
----------------	-----------------	---------	------	---

K.	R366-36	Nut, crank pin	1000cc	8.75	⊕
L.	R370-36	Lockwasher, crank pin nut	1000cc	1.00	⊕
	366-41	Nut, crank pin	'41-'53	12.00	⊕
	R366-41	Nut, crank pin	'41-'53	9.50	⊕
	369-41	Lockwasher, crank pin nut	'41-'53	3.00	⊕
	R369-41	Lockwasher, crank pin nut	'41-'53	0.80	⊕
	R369-41.25pack	25 Lockwashers	'41-'53	14.50	⊕
	23966-54A	Nut, crank pin	'54-'81	15.00	⊕
	R23966-54A	Nut, crank pin	'54-'81	12.00	⊕
	23971-54	Lockwasher, crank pin nut	'54-'81	3.00	⊕
	R23971-54	Lockwasher, crank pin nut	'54-'81	0.80	⊕

M.	364-36	Nut, sprocket & gear shaft		11.00	⊕
"	R364-36	Nut, sprocket & gear shaft		8.50	⊕
"	R364-36JIMS	Nut, sprocket & gear shaft		37.50	⊕

N.	R370-36	Lockwasher, sprocket & gear shaft nuts		1.00	⊕
O.	R030Z	Screw, fits all nut locks	zinc	0.30	⊕

P.	R358-17A	Set flywheel washers (11)	'48-'54 (.060" to .110" except .094")	21.50	⊕
----	-----------------	---------------------------	--	-------	---

R.	R372-36	Flywheel washer	1000cc .055"	8.50	⊕
"	R372-36B	Flywheel washer	1000cc .060"	9.00	⊕
"	R372-41	Flywheel washer	1200cc .055"	6.50	⊕
"	R372-41S	Flywheel washer	1200cc .060"	7.00	⊕
"	R372-41B	Flywheel washer	1200cc .060" (bronze)	7.00	⊕

R11967-38	End play gauge	All models '30-'54	45.00	⊕
------------------	----------------	--------------------	-------	---



H.

I.

J.

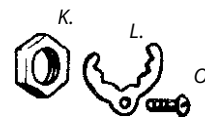

K.

L.

O.

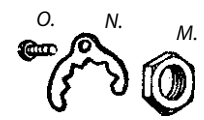

M.

N.



P.



R.

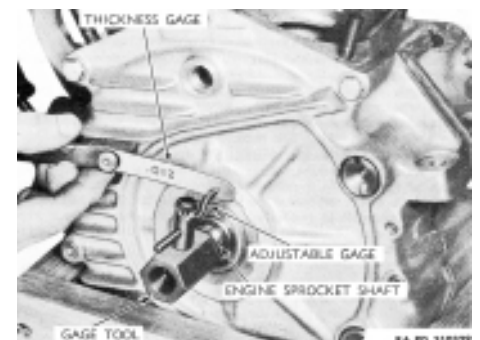

Lower Engine Parts

Right Side Bearing '40-'54

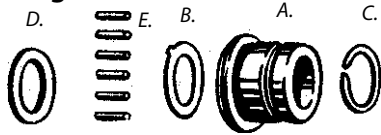

JIMS	A. R413-40A	Bearing race	std. O.D.	2.002"	145.00	✪
"	R413-40AB	Bearing race	oversize	+ .002"	65.00	✪
"	R413-40AC	Bearing race	oversize	+ .005"	65.00	✪
JIMS	R413-40ACji	Bearing race	oversize	+ .005"	165.00	✪
"	R413-40AD	Bearing race	oversize	+ .010"	67.00	✪
B.	R414-40	Washer, bearing		'40-'53	3.50	✪
"	R414-40.5pack	5 Bearing washers		'40-'53	13.50	✪
C.	R423-40	Ring, spring		'40-'52	1.10	✪
"	R423-40.10pack	10 Spring rings		'40-'52	7.50	✪
D.	R425-40	Spacer		'40-'54	4.00	✪
E.	R306-26	Roller, standard		0.2498" x .600"	0.60	✪
"	R306-26D	Roller, oversize		+ .0002"	0.60	✪
"	R306-26F	Roller, oversize		+ .0004"	0.60	✪
"	R306-26H	Roller, oversize		+ .0006"	0.60	✪
"	R306-26KA	Roller, oversize		+ .0008"	0.60	✪
"	R306-26MA	Roller, oversize		+ .0010"	0.60	✪
"	R306-26MA15	Roller, oversize		+ .0015"	0.60	✪
"	R306-26MA20	Roller, oversize		+ .0020"	0.60	✪

Right Side Bearing '58-up

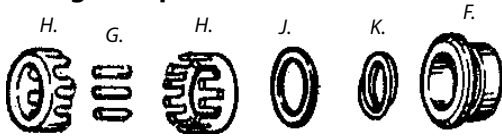

	R24599-58	Race, with locking detents	Std.		45.00	✪
JIMS	R24599-58-JI	Race, with locking detents	Std.		125.00	✪
	R24600-58	Race, with locking detents	+ .002"		65.00	✪
JIMS	R24600-58-JI	Race, with locking detents	+ .002"		147.50	✪
	R24601-58	Race, with locking detents	+ .005"		66.00	✪
	R24602-58	Race, with locking detents	+ .010"		67.00	✪
JIMS	R24602-58-JI	Race, with locking detents	+ .010"		150.00	✪
JIMS	R24603-58-JI	Race, with locking detents	+ .032"		150.00	✪
JIMS	R24599-58A-JI	Race, w/o locking detents	Std.		125.00	✪
	24600-58A	Race, w/o locking detents	+ .002"		85.00	✪
JIMS	R24600-58A-JI	Race, w/o locking detents	+ .002"		147.50	✪
JIMS	R24602-58A-JI	Race, w/o locking detents	+ .010"		150.00	✪
JIMS	R24603-58A-JI	Race, w/o locking detents	+ .032"		150.00	✪

	R24599-58B	Race, '93-up style oil flow	Std.		65.00	✪
JIMS	R24599-58B-JI	Race, '93-up style oil flow	Std.		125.00	✪
	R24600-58B	Race, '93-up style oil flow	+ .002"		64.00	✪
JIMS	R24600-58B-JI	Race, '93-up style oil flow	+ .002"		147.50	✪
	R24601-58B	Race, '93-up style oil flow	+ .005"		65.00	✪
JIMS	R24602-58B-JI	Race, '93-up style oil flow	+ .010"		150.00	✪
JIMS	R24603-58B-JI	Race, '93-up style oil flow	+ .032"		150.00	✪

G.	R2289-25	Roller, std.	0.250" x .490"	6,350 mm	0.50	✪
"	R9219	oversize	+ .0001"	6,353 mm	0.50	✪
"	R2289-25D	oversize	+ .0002"	6,355 mm	0.50	✪
"	R9218	oversize	+ .0003"	6,357 mm	0.50	✪
"	R2289-25F	oversize	+ .0004"	6,360 mm	0.50	✪
"	R9217	oversize	+ .0005"	6,353 mm	0.50	✪
"	R2289-25H	oversize	+ .0006"	6,365 mm	0.50	✪
"	R2289-25KA	oversize	+ .0008"	6,370 mm	0.50	✪
"	R2289-25MA	oversize	+ .0010"	6,375 mm	0.50	✪
"	R2289-25MA2	oversize	+ .0020"	6,400 mm	0.50	✪

Check website for 100-packs

H.	3967-35	Retainer, bearing roller		'58-'86	18.00	✪
"	R3967-35	Retainer, bearing roller		'58-'86	14.00	✪
	R24608-54	Lock screw for bearing race		'54-'78	1.80	✪
J.	24692-58	Washer, gear shaft bearing		'58-'86	14.00	✪
"	R24692-58	Washer, gear shaft bearing		'58-'86	3.25	✪
K.	11007	Retaining ring		'58-'86	2.20	✪
"	R11007	Retaining ring		'58-'86	1.00	✪

Right Side Bearing '55-'57

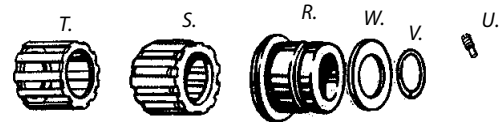

R.	R24599-55	Bearing race	std. O.D.	2.002"	72.00	✪
"	R24600-55	Bearing race	oversize	+ .002"	72.00	✪
"	R24601-55	Bearing race	oversize	+ .005"	73.00	✪
"	R24601-84	Bearing race	oversize	+ .010"	74.00	✪
"	R24601-85	Bearing race	oversize	+ .015"	75.00	✪
S.	24650-55	Bearing	Standard		65.00	✪
"	24651-55	Bearing	oversize	+ .0002"	65.00	✪
"	24652-55	Bearing	oversize	+ .0004"	65.00	✪
"	24653-55	Bearing	oversize	+ .0006"	65.00	✪
"	24654-55	Bearing	oversize	+ .0008"	65.00	✪
"	24655-55	Bearing	oversize	+ .0010"	65.00	✪
	R9421	Roller	Standard	0.1875"	0.40	✪
	R9422	Roller	oversize	+ .0002"	0.40	✪
	R9423	Roller	oversize	+ .0004"	0.40	✪
	R9424	Roller	oversize	+ .0006"	0.40	✪
	R9425	Roller	oversize	+ .0008"	0.40	✪
	R9426	Roller	oversize	+ .0010"	0.40	✪

T.	24718-54	Retainer, right bearing roller		'54-'57	45.00	✪
U.	R24608-54	Lock screw for bearing race		'54-'78	1.80	✪
V.	24701-54	Spring ring		'54-'57	4.00	✪
"	R24701-54	Spring ring		'54-'57	1.00	✪
W.	24692-54	Washer		'54-'57	4.50	✪
"	R24692-54	Washer		'54-'57	3.25	✪
"	R24692-54.10pack	10 Washers		'54-'57	22.50	✪

Left Side Bearing '40-'54

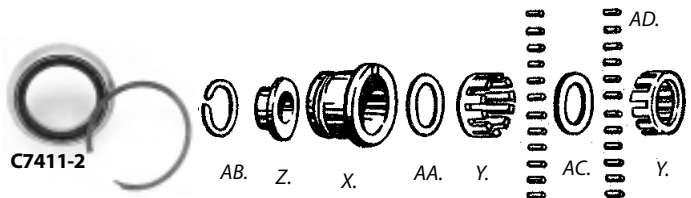

X.	R416-40	Bearing race	std. O.D.	2.002"	145.00	✪
"	R416-40B	Bearing race	oversize	+ .002"	65.00	✪
"	R416-40C	Bearing race	oversize	+ .005"	66.00	✪
"	R416-40E	Bearing race	oversize	+ .032"	165.00	✪

Y.	417-30	Retainer, left bearing roller			n.a.	✪
Z.	R421-40	End, left bearing			16.00	✪
	C7411-2	Oil seal (replaces steel ring 421-40)			27.50	✪
AA.	R422-40	Washer, left bearing			3.50	✪
AB.	R423-40	Spring ring			1.10	✪
AC.	R358-36	Left bearing spacer		'36-'54	4.25	✪

AD.	R2289-25	Roller, standard	0.2498" x .490"		0.50	✪
"	R9219	Roller, oversize	+ .0001"		0.50	✪
"	R2289-25D	Roller, oversize	+ .0002"		0.50	✪
"	R9218	Roller, oversize	+ .0003"		0.50	✪
"	R2289-25F	Roller, oversize	+ .0004"		0.50	✪
"	R9217	Roller, oversize	+ .0005"		0.50	✪
"	R2289-25H	Roller, oversize	+ .0006"		0.50	✪
"	R2289-25KA	Roller, oversize	+ .0008"		0.50	✪
"	R2289-25MA	Roller, oversize	+ .0010"		0.50	✪
"	R2289-25MA2	Roller, oversize	+ .0020"		0.50	✪

Check website for 100-packs

Left Side Bearing '55-up

L.	9029	Bearing, sprocket shaft	110.00
"	R9029	Bearing, sprocket shaft	88.50
	R9045	Bearing cup and cone only	19.00
M.	R23741-55	Shim, bearing .003"	1.00 ☺
N.	R24031-55	Bearing nut, O.E.M. style	31.00 ☺
"	C7410-1	Bearing nut, with oil seal	52.50 ☺
"	C7410-1-US	Bearing nut .002" undersize threads	53.75 ☺
"	C7410-1-OS	Bearing nut .002" oversize threads	53.75 ☺
O.	24779-55	Retaining ring	3.00 ☺
"	R24779-55	Retaining ring	2.00 ☺
"	R24779-55.5pack	5 Retaining rings	7.50 ☺
P.	24029-55	Spacer, shaft .336"	16.00 ☺
"	R24029-55	Spacer, shaft .336"	7.50 ☺

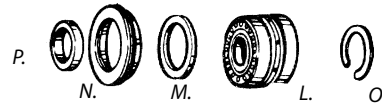

Lapping Tools

R11955-40	Bearing race lapping tool	'40-'54	475.00 ☺
R96710-55	Bearing race lapping tool	'55-'57	475.00 ☺
R96710-58	Bearing race lapping tool	'58-up	475.00 ☺
R96717-40	Lap head only	1.500" '40-'54	95.00 ☺
R96718-40	Lap head only	1.375" '55-'57	95.00 ☺
R96718-58	Lap head only	1.750" '58-up	99.00 ☺

R96710-40 Crankcase main bearing race lapping tool 645.00 ☺
Complete set, use on 40-up Big Twins, Sportster, 750cc.
R96710-80 Crankcase main bearing race lapping tool 895.00 ☺
Same as above, but also includes transmission lapping tools for Big Twins and Sportsters.

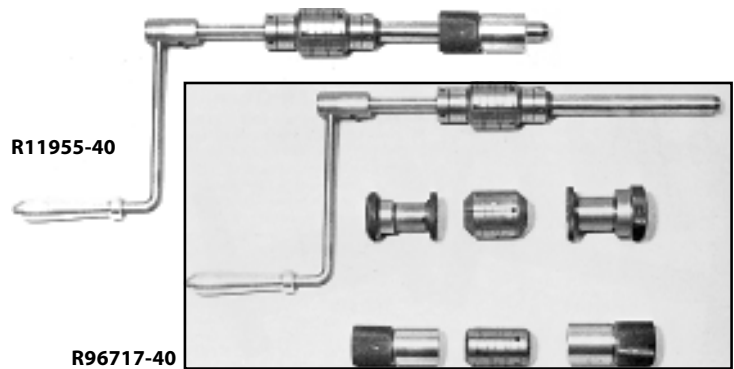

Jims Lapping Tool

This lapping tool is guided on both sides of the pinion bearing. This additional support on the cam gear side of the bearing race is achieved by means of a bolt-on base plate that precisely locates a drill bushing in which the lap turns. Now instead of guiding only from the left side with Timken bearings, which are a floating fit, this case lap uses a special ground bearing sleeve to hold the left side of lapping shaft without movement. Both ends of the lap are supported in precisely the same centerline as the flywheel assembly. With this extremely rigid arrangement, it is possible to power the lap with a low speed drill motor without fear of chatter in the lapped bearing race. (can also be turned by hand)
Use on Big Twins 1958-present.

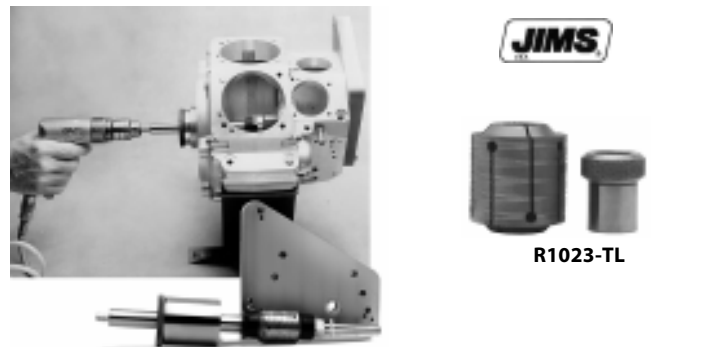

R96710.TL Crankcase main bearing race lapping tool 1290.00 ☺
In order to lap 4-speed transmissions, order **R1023-TL** with this tool.

Sprocket Shaft and Bearing Tools '55-up

R1047.TP Crank assembly removing tool '55-up 330.00 ☺
Use to press flywheels from cases (will also press cases apart).

R1048 Hard cap, sprocket shaft '55-up 64.50 ☺
Use to protect sprocket shaft when using tool **R1047-TP**, or a press.

R1045.TS Timken bearing remover '55-'85 355.00 ☺
Use to remove Timken bearing from sprocket shaft.

R97194-57 Outer race tool '55-'68 30.00 ☺
To remove and install outer bearing race.

R97225-55 Bearing installation tool '55-up 275.00 ☺
Use to install crank shaft assembly into crankcase bearing. Torque nut with tool B94660-37A transmission sprocket wrench for consistent professional results.



R97235-55B Bearing nut wrench, use w. ratchet wrench 185.00 ☺

Lower Engine Parts

Motor Mounting

A.	R437-36P	Bolt, front	park	6.25	✳
"	R437-36	Bolt, front	cad	6.25	✳
"	R437-36C	Bolt, front	chrome	7.25	✳
"	24791-36	Bolt, front, for flexlock nut	"1038 cp"	7.00	✳
B.	R438-36P	Bolt, rear	park	7.50	✳
"	R438-36	Bolt, rear	cad	7.50	✳
"	R438-36C	Bolt, rear	chrome	8.75	✳
C.	R0224P	Washer	park	0.63	✳
"	R0224	Washer	cad	0.63	✳
"	R0224C	Washer	chrome	0.88	✳
D.	R0128P	Nut	park	2.00	✳
"	R0128	Nut	cad	2.13	✳
"	R0128C	Nut	chrome	2.31	✳
"	R7775P	Nut, flexlock	park	2.81	✳
"	R7775	Nut, flexlock	cad	2.81	✳
E.	R439-36	Nut, front right	park	12.50	✳
F.	R439-36AP	Lockwasher, motor bolt	park	3.75	✳
"	R439-36A	Lockwasher, motor bolt	cad	3.75	✳
G.	R0291P	Cotter pin	park	0.19	✳
"	R0291	Cotter pin	zinc	0.15	✳

Motor Mount Kits

Include lower and upper (bracket to frame) bolts, nuts, washers, shims.

C9627-19	Upper and lower kit	park	66.25	✳
C3678-16	Lower kit only	'48-'57 park	49.25	✳
C3681-16	Lower kit only	'58-'65 park	38.20	✳
C8165-19	Upper and lower kit	cad	66.25	✳
C3680-16	Lower kit only	'48-'57 cad	49.25	✳
C3683-16	Lower kit only	'58-'65 cad	38.20	✳
C8164-19	Stock kit	chrome	73.75	✳
C3679-16	Lower kit only	'48-'57 chrome	53.50	✳
C3682-16	Lower kit only	'58-'65 chrome	41.50	✳
C7603-4	Acorn kit	lower chrome	38.75	✳
C7604-7	Acorn kit	upper chrome	23.75	✳

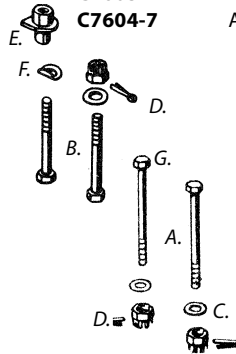

COLONY

Crankcase Bolts and Studs

H.	R444-30P	Bolt	park	4.38	✳
"	R444-30	Bolt	cad	4.38	✳
"	R444-30C	Bolt	chrome	5.31	✳
I.	446-30	Stud 5"		12.00	✳
"	R446-30	Stud 5"		7.50	✳
"	R446-37	Stud 7-1/8"		7.50	✳
"	447-30	Stud 6"		12.00	✳
"	R447-30	Stud 6"		7.50	✳
"	R447-36	Stud 5-7/16"		7.50	✳
"	24815-40	Stud 5-7/8" press fit		11.00	✳
"	R447-48	Stud 5-7/8" press fit		11.25	✳
J.	R0117P	Nut "machined"	park	1.19	✳
"	R0117M	Nut "machined"	cad	1.25	✳
"	R0117C	Nut	chrome	0.94	✳

Crankcase Kits

C3014-34	Stock kit	park	'48-'64	61.25	✳
C8135-34	Stock kit	cad	'48-'64	61.25	✳
C8134-34	Stock kit	chrome	'48-'64	72.50	✳
C8133-34	Acorn kit	chrome	'48-'64	75.00	✳
C8138-34	Stock kit	cad	'65-'69	61.25	✳
C8137-34	Stock kit	chrome	'65-'69	72.50	✳
C8136-34	Acorn kit	chrome	'65-'69	75.00	✳

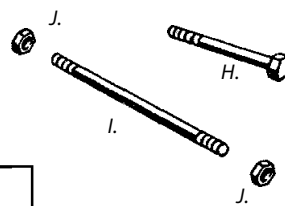

Timing Hole Plugs

- '38-'51 plugs have 7/8" hex size (wrench size).
- '52-'69 plugs have 3/4" hex size (wrench size).
- To repair stripped threads use oversize plugs.
- Oversize plugs are available with 3/4" hex size only.
- Custom style plugs have 9/16" hex size (wrench size).

Standard plugs, 5/8"-18 thread

R2326-38P	Hex plug	'38-'51	park	7.50	✳
R2326-38	Hex plug	'38-'51	cad	7.50	✳
R2326-38C	Hex plug	'38-'51	chrome	10.63	✳
C8115-1	Hex plug	'52-'69	cad	6.25	✳
C8114-1	Hex plug	'52-'69	chrome	9.38	✳
C7106-1	Acorn plug		chrome	11.25	✳
C8441-1	Cap plug		chrome	10.00	✳
C8612-1	Custom plug		black	10.00	✳
C8611-1	Custom plug		cad	10.00	✳
C8610-1	Custom plug		chrome	12.50	✳
C9403-1	Allen plug		cad	8.13	✳
C9402-1	Allen plug		chrome	10.63	✳

Oversize plugs, 11/16"-16 thread

C9714-1	Hex plug		park	6.25	✳
C9404-1	Hex plug		cad	6.25	✳
C9304-1	Hex plug		chrome	9.38	✳
C9960-1	Allen plug		chrome	10.31	✳
C7501-1	Acorn plug		chrome	10.63	✳
C7500-2	Acorn plug and tap		chrome	53.75	✳
C9407-1	Tap only	11/16"-16		45.00	✳
C2282-1	Special tap	can be used on assemb. cases		45.00	✳

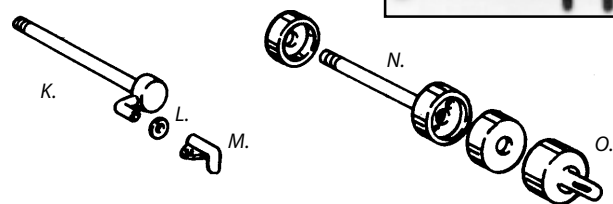

K.	R543-48	Breather pipe, stud	'48-'57 + '64	35.00	✳
L.	R543-39	Rubber washer	'39-'57 + '64	1.80	✳
M.	R3803-39A	Oil deflector	'39-'57	n.a.	
N.	R24913-58	Breather pipe	'58-'63	32.00	✳
O.	24918-58	Breather nipple	'58-'63	17.00	✳
"	R24918-58	Breather nipple	'58-'63	8.50	✳
	C3113-5	Breather pipe assembly	'58-'63	75.00	✳

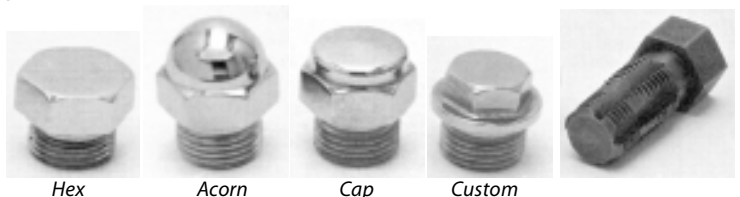

Heli-Coil® thread repair

Repair kit includes 6 inserts, tap and installation tool.

H5528-10-2	Thread repair kit	5/8"-18	n.a.	✳
HR1191-10-2	Set inserts only	(6)	38.00	✳

Drain Plugs

453-11	Drain plug	park	6.00 ☺
R453-11P	Drain plug	park	4.38 ☺
R453-11	Drain plug	cad	4.38 ☺
R453-11C	Drain plug	chrome	6.25 ☺
R453-11SP	Drain plug, oversize 7/16-20	park	6.25 ☺
R453-11S	Drain plug, oversize 7/16-20	cad	6.25 ☺
R453-11SC	Drain plug, oversize 7/16-20	chrome	6.88 ☺



Gear Cover Screws

056	Screw	park	1.95 ☺
R056P	Screw	park	1.88 ☺
R056	Screw	cad	1.88 ☺
R056C	Screw	chrome	2.31 ☺
2341HW	Screw	zinc	2.00 ☺



Heli-Coil® thread repair

H5540-4	Heli-coil repair kit	1/4"-24	125.00 ☺
(includes 12 inserts, tap and installation tool, order drill separately)			
HR389-4	Set Heli-coil inserts only (12)		25.00 ☺
M6117D	Drill, use with repair kit	17/64"	n.a. ☺

Heli-Coil® thread repair

To repair stripped drain plug hole.

H5528-6	Repair kit	3/8"-24 thread	65.00 ☺
HR1191-6	Set inserts only	(12)	26.00 ☺
M6125D	25/64" drill, use with kit		n.a. ☺



Gear Cover Screw Sets (12)

C9621-12	Stock (slotted head)	park	22.50 ☺
C8150-12	Stock (slotted head)	cad	22.50 ☺
C8149-12	Stock (slotted head)	chrome	27.50 ☺
C2102-12	Stock (Phillips head)	cad	26.25 ☺
C2101-12	Stock (Phillips head)	chrome	30.00 ☺
C8755-12	Allen heads	chrome	29.38 ☺
C7129-12	Acorn heads	chrome	42.50 ☺
C8445-12	Cap heads	chrome	41.25 ☺

Special Size Screw Sets

1/4"-20 screws are commonly used on aftermarket crankcases.

C9796-12	Set 1/4"-20 screws	park	18.75 ☺
C9795-12	Set 1/4"-20 screws	cad	19.38 ☺
C9794-12	Set 1/4"-20 screws	chrome	24.38 ☺
C9827-12	Set 1/4"-20 Allen screws	chrome	29.38 ☺

A.	R598-36	Gasket, gear cover	'48-'64	3.50 ☺
"	R25225-36C	Gasket, gear cover	'65-'69	3.50 ☺
	25218-63	Oil passage bolt	zinc '63-'65	14.00 ☺
	C8772-2	Oil passage bolt	cad '63-'65	13.79 ☺
	C8771-2	Oil passage bolt	chrome '63-'65	15.63 ☺

B.	R620-30	Bushing		22.50 ☺
JIMS C.	R636-36	Stud, idler gear	'36-'69	42.50 ☺
D.	R636-36A	Screw, idler gear stud		5.00 ☺

E.	R637-36B	Spacers (2) early style	'36-'57	12.00 ☺
"	637-36B	Spacers (2) late style	'58-'69	13.00 ☺
F.	R658-15	Spring ring, stud	'36-'57	0.60

JIMS G.	R637-36ji	Stud, timer drive gear	'36-'57	32.50 ☺
"	R637-36	Stud, timer drive gear	'36-'57	11.00 ☺
"	637-36	Stud, timer drive gear	'58-'69	10.00 ☺
"	R25856-36	Stud, timer drive gear	'58-'69	8.50
('36-'57 stud has groove for spring ring 658-15)				

H.	R637-36A	Screw, stud	'36-early '59	5.50 ☺
"	1430	Screw, stud left hand	late '59-'69	3.50 ☺
"	R1430	Screw, stud left hand	late '59-'69	3.75 ☺

I.	R660-36	Bushing, cam gear, crankcase	'36-'57	20.00 ☺
J.	R9058	Bearing (Torrington)	'58-'99	20.00
K.	25550-57	Thrust washer	'58-up	7.00 ☺
"	R25550-57	Thrust washer	'58-up	3.00 ☺
L.	661-36	Bushing, cam gear, cover	'36-'69	17.00 ☺
"	R661-36	Bushing, cam gear, cover	'36-'69	17.00 ☺
"	R661-36.005	Bushing, +.005" O.S.	'36-'69	19.00 ☺
M.	661-31	Pin, bushing	'36-up	0.80 ☺
"	R661-31	Pin, bushing	'36-up	0.30 ☺

	R664-36Set	Set of 10 thrustwashers	.050"- .095"	24.00 ☺
N.	R664-36MA	Thrustwasher, cam gear	.045"	2.50 ☺
"	R664-36	Thrustwasher, cam gear	.050"	2.50 ☺
"	R664-36A	Thrustwasher, cam gear	.055"	2.50 ☺
"	R664-36B	Thrustwasher, cam gear	.060"	2.50 ☺
"	R664-36C	Thrustwasher, cam gear	.065"	2.50 ☺
"	R664-36D	Thrustwasher, cam gear	.070"	2.50 ☺
"	R664-36E	Thrustwasher, cam gear	.075"	2.50 ☺
"	R664-36F	Thrustwasher, cam gear	.080"	2.50 ☺
"	R664-36G	Thrustwasher, cam gear	.085"	2.50 ☺
"	R664-36H	Thrustwasher, cam gear	.090"	2.50 ☺
"	R664-36JA	Thrustwasher, cam gear	.095"	2.50 ☺
"	R664-36KA	Thrustwasher, cam gear	.100"	2.50 ☺
"	R664-36MA105	Thrustwasher, cam gear	.105"	4.50
"	R664-36MA110	Thrustwasher, cam gear	.110"	4.50

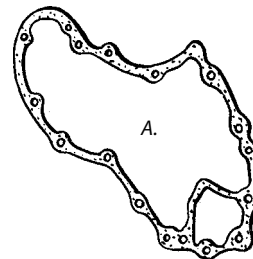

C8771-2

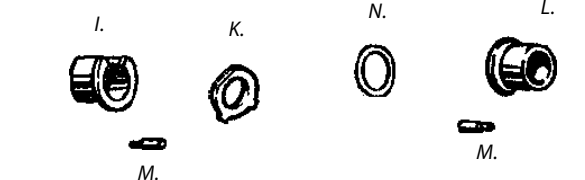
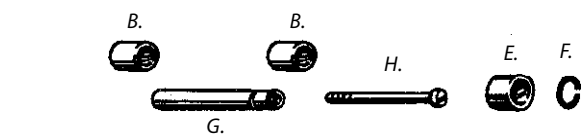
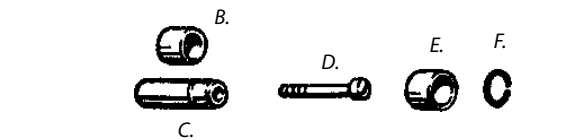

R24490-36T	Crankcase guard	28.00
-------------------	-----------------	-------

Lower Engine Parts

A.	R356-40A	Seal ring	'40-'53	18.00	✚
B.	R355-40	Spacer, pinion gear	'40-'52	3.25	✚
C.	24703-54	Spacer, pinion gear	'54-up	4.00	✚
"	R24703-54	Spacer, pinion gear	'54-up	3.25	✚
"	24703-54B	Spacer, pinion gear (plastic)	'54-up	7.00	✚
D.	R355-37B	Spring, seal ring	'39-'69	1.50	✚
E.	R661-36A	Bushing, gear shaft	'36-'53	17.00	✚
"	R661-36A.005	Bushing +.005"	'36-'53	19.00	✚
F.	R25582-54	Bushing, gear shaft	'54-early'73	12.00	✚
G.	661-31	Pin, bushing	'36-up	0.80	✚
"	R661-31	Pin, bushing	'36-up	0.30	✚
H.	26349-54	Oil pump drive gear 5T	'54-'72	75.00	✚
"	R26349-54	Oil pump drive gear 5T	'54-'72	22.00	✚
"	R26349-54.5pack	5 Oil pump drive gears		80.00	✚
I.	24023-54	Nut, pinion shaft	'54-'89	21.00	✚
"	R24023-54	Nut, pinion shaft	'54-'89	7.00	✚
"	R24023-54JIMS	Nut, pinion shaft	'54-'89	25.00	✚
J.	R23985-54	Key, pinion gear shaft	'54-'84	1.00	✚
K.	R24010-OR	Pinion gear orange	'54-'77	200.00	✚
"	R24010-BLK	Pinion gear black	'54-'77	n.a.	✚
"	R24010-RE	Pinion gear red	'54-'77	200.00	✚
"	R24010-BLU	Pinion gear blue	'54-'77	200.00	✚
"	R24010-GR	Pinion gear green	'54-'77	200.00	✚
"	R24010-WH	Pinion gear white	'54-'77	200.00	✚
"	R24010-BR	Pinion gear brown	'54-'77	200.00	✚
"	R24010-YE	Pinion gear yellow	'54-'77	200.00	✚

Pinion Gear Sizes

	Gear size over .105" pins	Cam gear size over .105" pins
orange	1.4490- 1.4485	2.7665- 2.7670
black	1.4485- 1.4480	2.7670- 2.7675
red	1.4480- 1.4475	2.7675- 2.7680
blue	1.4475- 1.4470	2.7680- 2.7685
green	1.4470- 1.4465	2.7685- 2.7690
white	1.4465- 1.4460	2.7690- 2.7695
brown	1.4460- 1.4455	2.7695- 2.7700
yellow	1.4455- 1.4450	2.7700- 2.7705

L.	R623-39	Gear, oil pump drive 25T	'39-'72	n.a.	✚
M.	R634-15	Key, oil pump gear		0.80	✚
N.	R695-36	Spring ring, drive shaft		0.60	✚
O.	R638-36	Drive shaft, oil pump		46.50	✚
"	R638-36OS	Drive shaft, oil pump +.005"		75.00	✚
P.	R412-36	Bushing, oil pump shaft		25.00	✚
"	412-36us	Bushing, oil pump shaft undersize I.D.		9.00	✚

R.	504-36A	Screen, breather valve		5.00	✚
S.	585-36	Screen, breather		5.50	✚
"	R585-36	Screen, breather		3.50	✚
T.	R585-36A	Separator, breather screen		3.75	✚

U.	R2338S	Breather valve gear	'48-early'77	150.00	✚
"	R2338	oversize	+.030"	147.50	✚

(above gears require '79-'82 type thrust washers with large hole)

	R25316-52	Thrustwasher	.110"	3.00	✚
	R505-50	Thrustwasher	.115"	3.00	✚
	R505-50A	Thrustwasher	.120"	3.00	✚
	R505-50B	Thrustwasher	.125"	3.00	✚
V.	R25313-set	Breather valve thrust washers (4)		12.00	✚
	R25302-set	Breather valve thrust washers (8) '79-'82		21.00	✚
	R25319-set	Breather valve thrust washers (8) '82-up		18.00	✚

(use with plastic gears)

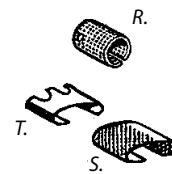
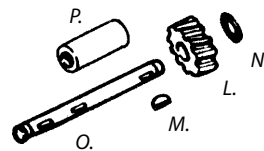
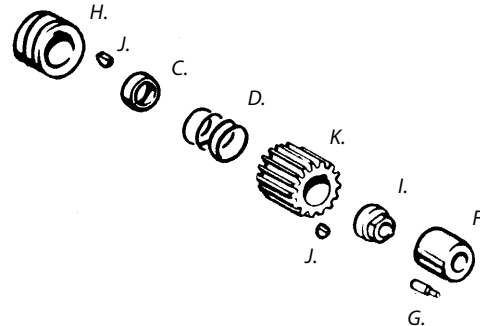
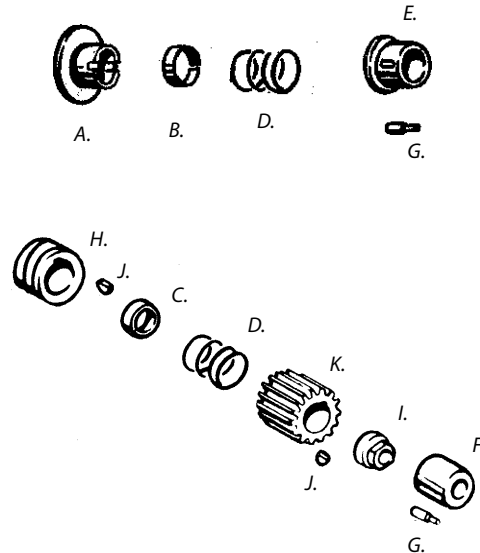
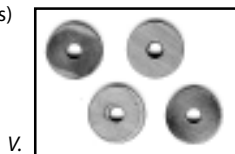

	R26551-39C	Oil pressure switch kit	'48-'84	27.00	✚
W.	R26552-72	Oil pressure switch only	'58-'84	19.00	✚
X.	26560-63	Terminal, oil pressure switch late '63-'76		4.00	✚
	26569-58	Fitting, oil pressure switch		6.00	✚

(fitting is used to fit '58-up style switches with NPT thread on earlier models)

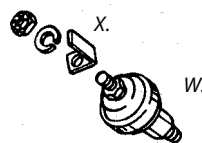

A.	24985-52	Valve body	late '52-'62	6.00 ☺
"	R24985-52	Valve body	late '52-'62	4.50
B.	R24992-52	Spring	early '52	1.50
	24975-63	Oil screen	'63-'65	n.a. ☺
	24979-63	Spring, oil screen	'63-'65	2.50 ☺
	R24979-63	Spring, oil screen	'63-'65	1.20
D.	R24990-52	Seal, check valve cork	late '52-'65	1.50
	24994-52	Gasket, check valve	late '52-'65	1.50 ☺
E.	24987-52	Oil screen plug	zinc '52-'65	14.00 ☺
"	C9604-2	Oil screen plug	cad '52-'65	11.88 ☺
"	C9603-2	Oil screen plug	chrome '52-'65	15.63 ☺
"	C8704-2	Plug, hex head	chrome '52-'65	15.00 ☺

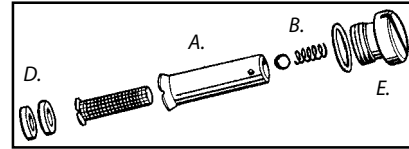

C9603-2



C8704-2



R2233 Tool 45.00 ☺
Tappet oil screen plug tool
Use to remove slotted plugs.

Tools

R2281	Cam bushing puller	'36-'69	250.00 ☺
To easily remove cam bushing from cover.			
R95760-TP	Gear shaft bushing puller	'54-up	235.00 ☺
Use to remove bushing from cam cover in one easy operation.			



R2281



R95760-TP



Bushing installing and drilling tools
Use to press in bushing and drill through guide hole at factory location.
Complete with instructions and drill size # 31.

R1011.36TB	For cam bushings 661-36 & 660-36	71.50 ☺
R1018.37TB	For gear shaft bushing 661-36A	71.50 ☺
R1013.54TB	For gear shaft bushing 25582-54	71.50 ☺
R1097	Replacement drill	12.50 ☺

Gear shaft bushing line reamer, use to line gear shaft bushing in gear cover from right crankcase bearing race. The finest precision reamer available. Reamer and pilot must be ordered separately.







R94805-57-1	Reamer	'54-up	325.00 ☺
R94805-57-3	Pilot 1-3/8"	'36-'57	175.00 ☺
R94805-57-2	Pilot 1-3/4"	'58-up	145.00 ☺



R94805-57-3

R94805-57-2

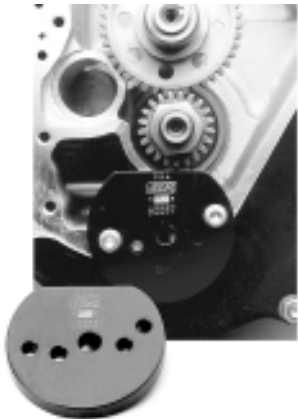
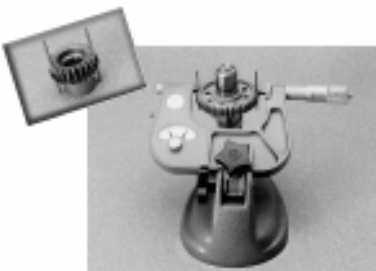
Lower Engine Parts

<p>R95760-TB Cam bearing puller '58-up 255.00 ☼</p> <p>Use to remove cam bearing without splitting cases. Easily pulls bearing from case, also keeps rollers from coming out during removal.</p> 	<p>R2188 Cam bearing installer '58-up 225.00 ☼</p> <p>Easily presses the inner cam bearing smoothly to the proper depth.</p> 
<p>R97272-60 Cam bearing installing tool '58-up 110.00 ☼ (or use R2188 bearing installer)</p> <p>R33416-80 Handle, use with above installing tool 70.00 ☼ (approximately 12" long)</p> 	<p>R2249 Cam bearing gauge set '58-up 114.50 ☼</p> <p>Go & No Go Gauge, the only accurate and easy way to check the size of the inside diameter of your inner cam bearing.</p> 
<p>R94555-55A Pinion gear nut wrench '54-'89 69.50 ☼</p> <p>Use to secure nut to gear shaft, 1/2" drive.</p> 	<p>R2237 Pinion gear lock tool '54-up 210.00 ☼</p> <p>Use to lock pinion gear, necessary to torque the pinion nut. Tool is simple to use, just align underneath gear and screw into case.</p> 
<p>R1110 Cam and pinion gear gauge pins '54-'89 n.a.</p> <p>Use to check pinion and cam gears for pitch diameters. A complete sizing chart is included. 0.105" pins.</p> 	<p>R96830-51 Pinion gear puller '39-up 365.00 ☼</p> <p>Use to remove pinion gear on all Big Twin, Sportster, and 750cc models. Use to install press fit pinion gear on '51-'53 models.</p> 
	<p>R1066 Cam installation tool '48-up 55.00 ☼</p> <p>This handy tool makes cam installation on '48-up Big Twins easier. You don't have to remove rocker covers to install the cam. This tool holds your tappets up in the lifter blocks while you make your cam change.</p> 

A.	R589-41	Gasket, oil pump body	'41-'67	1.00 ☼
"	R589-41.10pack	10 Body gaskets	'41-'67	7.00 ☼
B.	R684-41	Gasket, pump cover plate	'41-'49	2.00 ☼
C.	R685-41	Gasket, oil pump cover	'41-'49	2.00 ☼
D.	R26257-50A	Gasket, oil pump cover	'50-'67	1.00 ☼
"	R26257-50A.10pack	10 Cover gaskets	'50-'67	7.00 ☼

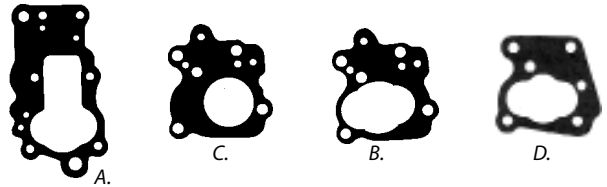

E.	R412-36	Bushing, oil pump shaft	'36-up	25.00 ☼
"	412-36us	Bushing, oil pump shaft	undersize I.D.	9.00 ☼
F.	R638-36	Drive shaft	'36-'69	46.50 ☼
"	R638-36OS	Drive shaft +.005"	'36-'69 (oversize in bushing area only)	75.00 ☼

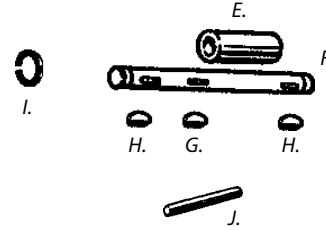

	26317-62	Idler gear (feed side)	'62-'67	26.00 ☼
	26326-62A	Idler gear (scavenger side)	'62-'67	29.00 ☼
G.	693-36	Key, oil pump gear	'36-'67	2.50 ☼
"	R693-36	Key, oil pump gear	'36-'67	1.35 ☼
H.	R634-15	Key, oil pump gear	'36-up	0.80 ☼

I.	R695-36	Spring ring, drive shaft	'36-'69	0.60
J.	R697-41	Shaft, idler gear	'41-late'62	11.00 ☼
"	R26327-52	Shaft, idler gear	late '62-'67	10.00 ☼

K.	R701-36P	Plug, check valve	park '36-'80	10.00 ☼
"	R701-36	Plug, check valve	cad '36-'80	10.00 ☼
"	R701-36C	Plug, check valve	chrome '36-'80	12.50 ☼
"	C8702-2	Plug, hex head	chrome '36-'80	13.75 ☼

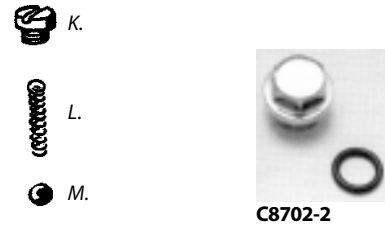

L.	R703-36	Spring, check valve	'36-'55	1.50 ☼
"	26363-56	Spring, check valve	'56-'65	3.50 ☼
"	R26363-56	Spring, check valve	'56-'65	1.25 ☼

M.	R704-36	Ball, check valve		0.40
----	----------------	-------------------	--	------

N.	R707-36P	Plug, relief valve	park '36-'52	10.63 ☼
"	R707-36	Plug, relief valve	cad '36-'52	10.63 ☼
"	R707-36C	Plug, relief valve	chrome '36-'52	12.50 ☼

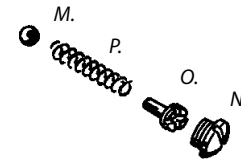

M.	R704-36	Ball, by-pass valve	'36-'52	0.40
----	----------------	---------------------	---------	------

O.	711-36	Screw, by-pass valve adj.	'36-'52	5.00 ☼
P.	R713-42	Spring, oil pump by-pass	'41-'52	1.40

R.	C9606-2	Plug, relief valve	cad '54-'67	11.88 ☼
"	C9605-2	Plug, relief valve (plugs include washer)	chrome '54-'67	16.88 ☼

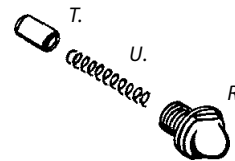

S.	R6581	Washer	brass	0.95 ☼
"	26231-78	Washer	fibre	2.50 ☼



T.	R26400-54	Plunger, relief valve	'54-'82	8.50 ☼
U.	R26374-54	Spring, relief valve	'54-'72	1.20

V.	R3577-15P	Nipple, feed line	park	5.00 ☼	(also '36-'49 return line)
"	R3577-15	Nipple, feed line	cad	5.00 ☼	(also '36-'49 return line)
"	R3577-15C	Nipple, feed line	chrome	6.25 ☼	(also '36-'49 return line)
"	63533-15	Nipple, feed line	zinc	9.00 ☼	(also '36-'49 return line)

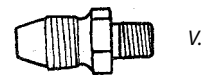

W.	R63526-50	Nipple, return line	cad	8.75 ☼	('50-'57 with filter)
X.	26424-50	Nipple, return line	cad	12.00 ☼	('50-'64 without filter, '58-'64 with filter)
"	R26424-50	Nipple, return line	cad	6.88 ☼	('50-'64 without filter, '58-'64 with filter)

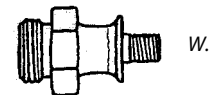

	R6377	Washer, pump nipple	brass	0.50 ☼	('50-'67)
--	--------------	---------------------	-------	--------	-----------



R3583-15 Cap, oil line nipple cad 2.19 ☼
Use on flare type nipples (3577-15 and 26424-50) and on oil tank when oil lines are disconnected to prevent leakage or contamination during storage.



Oil Pump

Oil Pump Mounting Parts

A.	591-36	Stud	1-11/16"	(2)	'36-'67	3.00	✳
"	R591-36	Stud	1-11/16"	(2)	'36-'67	3.25	✳
B.	591-36A	Stud	2-1/4"	(4)	'36-'67	4.00	✳
"	R591-36A	Stud	2-1/4"	(4)	'36-'67	3.44	✳
C.	591-41A	Nut, long		park	'41-'67	8.00	✳
"	R591-41AP	Nut, long		park	'41-'67	5.63	✳
"	R591-41A	Nut, long		cad	'41-'67	5.63	✳
"	R591-41AC	Nut, long		chrome	'41-'67	7.50	✳
D.	R692-41P	Bolt, cover		park	'41-'49	1.88	✳
"	R692-41	Bolt, cover		cad	'41-'49	1.88	✳
"	R692-41C	Bolt, cover		chrome	'41-'49	2.50	✳
E.	R692-41A	Screw, pump body		park	'41-'49	3.50	✳
F.	0108	Nut		park	'36-'67	1.50	✳
"	R0108P	Nut		park	'36-'67	1.13	✳
"	R0108M	Nut		cad	'36-'67	1.19	✳
"	R0108C	Nut		chrome	'36-'67	0.88	✳
G.	R0256P	Lockwasher		park		0.25	✳
"	R0256	Lockwasher		zinc		0.25	✳
"	R0256C	Lockwasher		chrome		0.38	✳

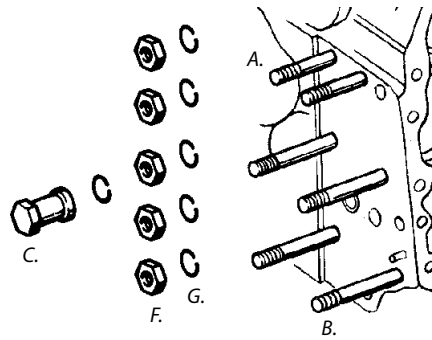

Oil Pump Mounting Kits

Kits include studs, nuts, bolts and lockwashers in stock, Allen, acorn or cap style. Acorn and cap kits are nuts only, Allen kit includes Allen screws to replace studs with nuts.

	C9694-19	Stock style		park	'41-'67	32.50	✳
	C8741-19	Stock style		cad	'41-'67	33.75	✳
	C8740-19	Stock style		chrome	'41-'67	41.25	✳
	C8745-13	Allen style		chrome	'41-'67	24.38	✳
	C7100-13	Acorn (nuts only)		chrome	'41-'67	22.50	✳
	C8439-13	Cap (nuts only)		chrome	'41-'67	23.13	✳

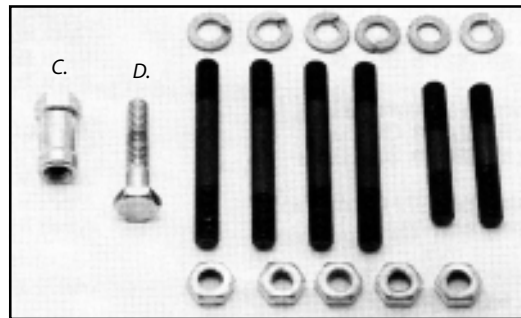

C8740-19

H.	R672-32	Adjusting screw, chain oiler		'36-'49	14.38	✳
I.	R0202	Washer		'36-'49	0.75	✳
J.	R674-32.10pack	10 shims	.002"	'36-'49	7.19	✳
	R672-32hex	Adjusting screw, chain oiler (hex head)			5.00	✳
L.	R26383-32	Adjust. screw, with nut		'50-'64	3.50	✳
M.	R0201A	Washer	brass	'50-'69	0.50	✳
	R0105AZ	Nut		'50-'69	0.50	✳



All oil pump hardware has special 1/4"-24 size thread.

	M1421T	Tap	1/4"-24	7.00	✳
	die160-005	Die	1/4"-24	n.a.	

Heli-Coil® thread repair

	H5540-4	Heli-coil repair kit	1/4"-24	125.00	✳
		(includes 12 inserts, tap and installation tool)			
	HR389-4	Set Heli-coil inserts only	(12)	25.00	✳
	M6117D	Drill, use with repair kit	17/64"	n.a.	✳

HeliCoil



R1052 Oil pump snap ring installer 94.50 ✳
To install outer snap ring on oil pump shaft, all Big Twin OHV oil pumps.



JIMS



Manifold

A.	R1108-41	Manifold	cad	'41-'54	n.a.
includes bushings					
B.	R1112-40	Nipple		'40-'54	26.25 ☉
"	R1112-40S	Nipple, oversize threads		'40-'47	26.25 ☉
C.	R1112-32A	Rivet, nipple	1/4"		1.25 ☉
D.	R1115-40P	Nut	park	'40-'54	18.13 ☉
"	R1115-40	Nut	cad	'40-'54	18.75 ☉
"	R1115-40C	Nut	chrome	'40-'54	21.25 ☉
E.	R1118-40	Bushing	brass	'40-'54	10.00 ☉
"	R1118-40US	Undersize bushing	brass	'40-'47	10.31 ☉
F.	R1121-40	Gasket		'40-'65	1.50
	C2230-6	Nipple repair kit (lock screw)		'48-'54	28.75 ☉
G.	R1121-48	Insulating block		'48-'65	14.00 ☉
	C2763-5	Nipple installation tool		'40-'47	115.63 ☉
I.	C7315-3	Manifold, with seals		'55-'65	81.25 ☉
J.	R27060-55	Manifold seal	rubber	'55-'77	0.80
"	R27060-55-V	Manifold seal	Viton	'55-'77	4.25 ☉
K.	R27063-57	Clamp, manifold		'55-'70	7.00

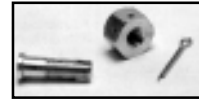
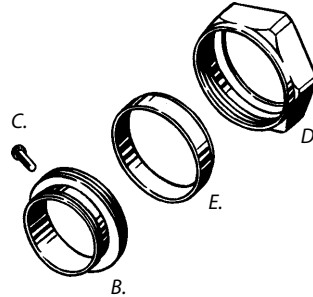
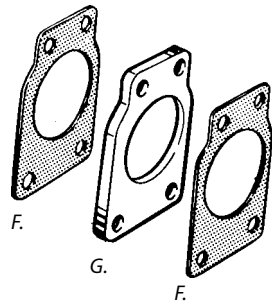

C2230-6

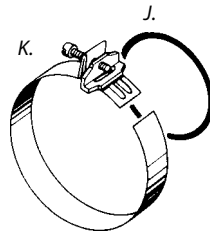

I.

Conversion Kit

to convert '40-'54 OHV "plumber" type manifolds to rubber band type.

C7314-9	Complete kit	123.75 ☉
One kit contains :		
	1 manifold	
	2 conversion nipples	
	2 manifold seals	
	2 nipple seals	
	2 rivets and 4 screws	
C7315-3	Manifold only	81.25 ☉
C7344-6	2 Conversion nipples, screw-in	47.50 ☉
C7627-4	2 Conversion nipples, weld-in	43.75 ☉



C7314-9

Mounting Screws

Short screws are used without insulator block.

R1123-39P	Screw, short	park	2.50 ☉
R1123-39	Screw, short	cad	2.50 ☉
R1123-39C	Screw, short	chrome	3.75 ☉

Long screws are used with insulator block.

R1123-48P	Screw, long	park	2.81 ☉
R1123-48	Screw, long	cad	2.81 ☉
R1123-48C	Screw, long	chrome	4.06 ☉

R0259P	Lockwasher	park	0.25 ☉
R0259	Lockwasher	zinc	0.25 ☉
R0259C	Lockwasher	chrome	0.38 ☉

Mounting Screw Kits

Short screws are used without insulator block.

C9672-8	Short screw kit	park	10.63 ☉
C8159-8	Short screw kit	cad	10.63 ☉
C8158-8	Short screw kit	chrome	16.25 ☉

Long screws are used with insulator block.

C9664-8	Long screw kit	park	10.63 ☉
C8930-8	Long screw kit	cad	10.63 ☉
C8929-8	Long screw kit	chrome	16.25 ☉



Carburetor

A.	R1152-11	Screw, needle valve adjusting	zinc	8.50
"	R1152-11cad	Screw, needle valve adjusting	cad	12.50
B.	R1153-11	Lockscrew, needle valve		0.40
C.	R1154-11	Lockspring, needle valve		2.00 *
D.	1251-33	Plug, idle passage		7.00 *
F.	R27337-27	Low speed needle valve complete		30.00 *
<hr/>				
G.	1263-24	Idle passage plug screw		3.00 *
"	R1263-24	Idle passage plug screw		2.20
"	R1264-27	Spring, needle valve		0.80 *
J.	1293-27	Screw, needle valve lever		6.00 *
"	R1293-27	Screw, needle valve lever		3.00 *
<hr/>				
	R1233-38	Choke lever and stud	cad	47.50 *
	R1233-38P	Choke lever and stud	park	47.50 *
K.	R1233-48	Choke rod	cad	30.00 *
L.	R1296-26	Spring, friction		0.80 *
M.	R1297-26	Ball, friction		0.35
<hr/>				
N.	R3370-36	Connection, incl. screw	cad	14.38 *
"	R3370-36S	Connection, oversize for worn levers		15.00 *
O.	R021	Screw, connection	cad	0.63 *
<hr/>				
P.	R1243-40	Throttle shaft		12.50 *
R.	R1245-24	Bushing, throttle shaft		3.00 *
S.	R1247-32	Spring, throttle shaft		1.00 *
"	R1247-32.10pack	10 Throttle shaft springs		8.25 *
<hr/>				
	27280-51	Disc, throttle		n.a.
<hr/>				
	R1254-50A	High speed needle late '50-'65		35.00 *
<hr/>				
	R1265-40	Venturi 1-1/8" for 1-1/2" carburetor		50.00 *
	C2710-1	+0.025" oversize		50.00 *
	R1265-41	Venturi 1-5/16" for 1-1/2" carburetor		51.25 *
	C2818-1	+0.025" oversize		51.25 *
<hr/>				
T.	R1276-36	Gasket, bowl		1.00 *
"	R1276-36.10pack	10 Bowl gaskets		7.00 *
U.	R1271-33	Float "Rubber Ducky"		44.00 *
V.	R1272-33	Lever, float		12.50
	R1272-33A	Stud and screw, float mount		4.25
W.	R1273-33A	Float valve & seat		29.06
X.	R1285-33	Washer, inlet nipple		1.80 *
Y.	R1196-11kit	Pin and screw kit, float lever		12.94 *
Z.	1197-16	Screw only, float lever pin		5.00 *
"	R1197-16	Screw only, float lever pin	cad	4.38 *
AA.	R1269-39	Drain screw and washer		9.38 *
AB.	R1257-33	Spring, nozzle retainer		1.20
AC.	1268-29	Nut, bowl lock	cad	15.00 *
"	R1268-29	Nut, bowl lock	cad	13.75 *
"	R1268-29C	Nut, bowl lock	chrome	16.25 *
"	R1268-29B	Nut, bowl lock	brass	17.50 *
"	C3121-6	Nut, with drain hole	cad	21.88 *
AD.	R1269-28	Gasket, bowl lock nut		2.06 *
<hr/>				
	R1110-41	Support bracket with nuts	'41-'53	13.75 *
	C2953-5	Support bracket with nuts	'54-early '55	24.38 *
	C9010-5	Support bracket with nuts	'54-'65	16.25 *
AG.	R0127P	Nut	park	1.50 *
"	R0127	Nut	cad	1.63 *
"	R0127C	Nut	chrome	1.06 *
AH.	R0261P	Lockwasher	park	0.25 *
"	R0261	Lockwasher	zinc	0.25 *
"	R0261C	Lockwasher	chrome	0.38 *

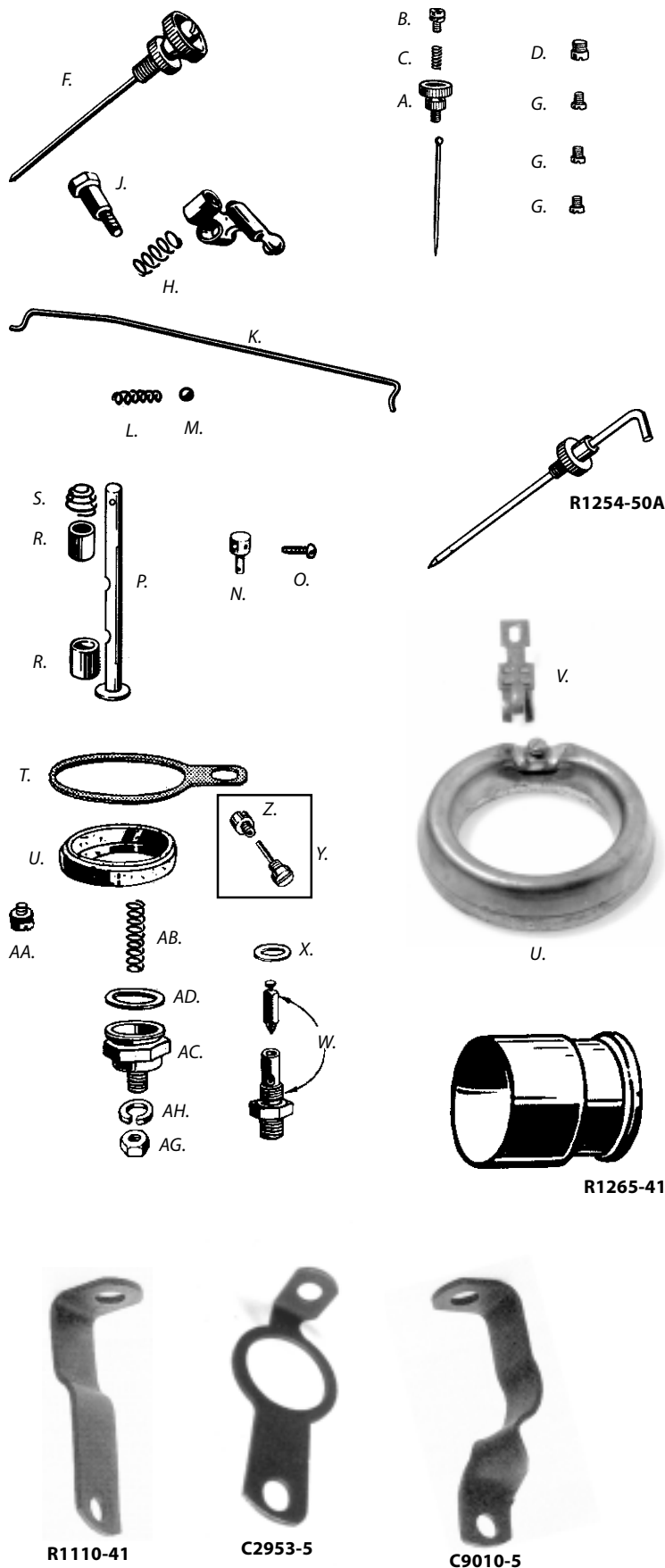

Special Carburetor Taps and Dies

tap160-002	Tap	1/4"-40	n.a.
High speed needle (in body), low speed needle valve lever (1292-27)			
tap160-003	Tap	1/4"-32	n.a.
Float lever pin and screw (1196-16, 1197-16), bowl drain screw (1269-39)			

Air Cleaner

F.	R1408-36	Lock ring	'37-'55	9.38 ☉
G.	R29060-56	Lock ring set	'56-'65	9.38 ☉
H.	R1409-36P	Bolt	park '37-'65	2.50 ☉
"	R1409-36	Bolt	cad '37-'65	2.50 ☉
	C2666-5	J-slot rivets and tool		16.25 ☉
	R1402-40R	Rivet only		2.50 ☉
	C9682-5	Mounting kit	park '37-'55	19.38 ☉
	C9017-5	Mounting kit	cad '37-'55	19.38 ☉
	C2924-6	Mounting kit	cad '56-'65	19.94 ☉

Air cleaner cover center screws, '56-up models.

I.	R2402W	Phillips head screw	chrome	2.50
J.	R2210-36C	Slotted head screw	chrome	3.44 ☉
"	C8212-3	Slotted head screw kit (3)	chrome	10.63 ☉
	C7206-2	Acorn head screw kit (2)	chrome	12.50 ☉
	C8461-2	Cap head screw kit (2)	chrome	12.50 ☉

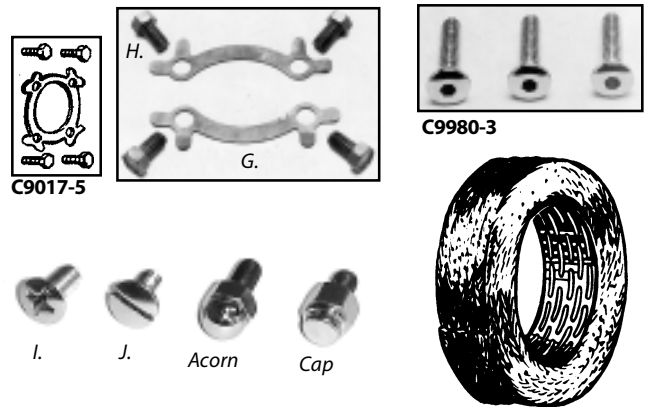

R1402-41	Backplate	42.00
R1404-41	Filter element	17.00
R1404-35	Mesh only	9.00
R1405-41	Spring, filter element	'41-'55 16.00 ☉

'58-'65 Generator Parts

K.	30011-58	Screw, mounting		11.00 ☉
"	R30011-58	Screw, mounting	cad	5.31 ☉
"	R30011-58C	Screw, mounting	chrome	7.50 ☉
"	C7113-2	Acorn screws (2)	chrome	15.00 ☉
"	C8443-2	Cap screws (2)	chrome	15.63 ☉
"	C8754-2	Allen screws (2)	chrome	13.75 ☉
"	C8754-2-P	Polished Allen screws (2)	chrome	15.00 ☉
L.	30012-58	Screw, frame		8.00 ☉
"	R30012-58	Screw, frame		4.00 ☉
M.	R31070-58	Gear, generator		9.00
"	R31070-58.10pack	10 Generator gears		69.00
N.	R7725	Nut, 5/16"-24 flexloc		1.88 ☉
O.	31035-58	Oil deflector		15.00 ☉
"	R31035-58	Oil deflector		11.00
P.	11004	Retaining ring, generator end		1.20 ☉
"	R11004	Retaining ring, generator end		0.70
R.	R1644-30	Bearing, gear end		11.00
S.	R1637-46	Oil seal, gear end		2.20
"	1637-46	Oil seal, gear end	metal O.D.	7.00 ☉
T.	R30143-58	Gasket, generator mounting		1.00 ☉
"	R30143-58.10pack	10 Generator gaskets		7.00 ☉
	30276-58	Pole shoe		65.00 ☉
U.	30280-58	Screw, pole shoe - slotted		1.50 ☉
"	R30280-58	Screw, pole shoe - hex socket		1.35
V.	30350-58	Mounting plate, brush holder		39.00 ☉
"	R30350-58	Mounting plate, brush holder		15.00
W.	R30426-58	Set of brushes, 2 brush	'58-'69	5.00
"	R30426-58.10pack	10 Set of brushes	'58-'69	35.00
X.	30453-58	Spring, brush	'58-'69	7.00 ☉
"	R30453-58	Spring, brush	'58-'69	1.00
Y.	30851-58	Armature	6V '58-'60	135.00 ☉
"	30851-61	Armature	6V '61-'64	95.00 ☉
	30201-65	Set field coils	12V '65-'69	67.00 ☉
Z.	R12002	Oil seal, brush end		2.00
AA.	R30148-58	Bushing, generator end cover	'58-'60	2.40
"	R9088	Bearing, generator end cover		7.00
"	R9064	Bearing, commutator end	'61-'69	6.00
	31096-58	Clip, terminal bolt		10.00 ☉
	C3406-2	Clip with bolt and gasket		14.38 ☉
AB.	31097-58	Insulator, terminal		4.00 ☉
"	R31097-58	Insulator, terminal		0.80
AC.	31098-58	Insulator, terminal bracket		2.00 ☉
"	R31098-58	Insulator, terminal bracket		0.65
AD.	R1666-32	Washer, terminal insulating		1.75 ☉
AE.	R0354	Lockwasher, external tooth		0.20 ☉
AF.	0105cop	Nut, 10-32	brass	0.70 ☉
	C2127-11	Terminal screws and fittings		20.00 ☉

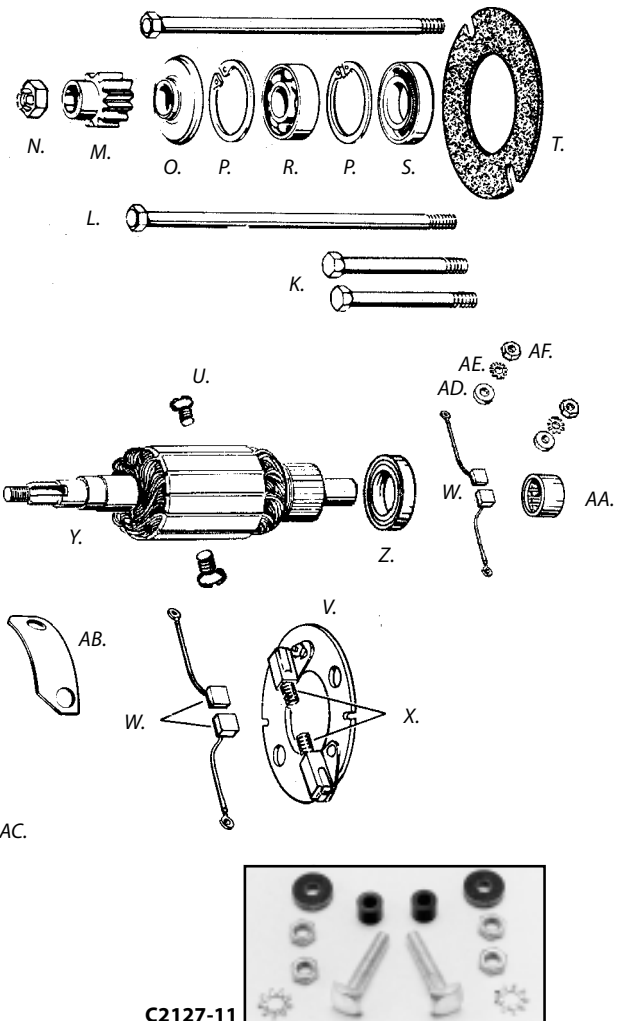

Heli-Coil® thread repair

H5528-5	Heli-Coil thread repair kit	5/16"-24	65.00 ☉
Thread repair kit includes tap, 12 inserts and installation tool.			
HR1191-5	Set Heli-Coil inserts	(12)	21.00 ☉
M6121D	Drill, use wit kit	21/64"	n.a. ☉

Generator

'32-'57 Generator and Mounting Parts

1501-32	Generator, 32E three brush		<i>not available</i>
A. R1527-30	Gasket, generator '30-'57		0.70 ☼
" R1527-30.10pack	10 Generator gaskets		5.00 ☼
B. R30144-32	Shim, paper		1.88 ☼
Paper shims are used to adjust gear lash.			
" R1510-45	Shim, steel		7.50 ☼
(optional, depending on gear size)			

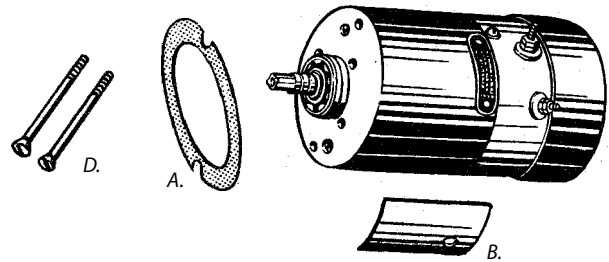

Mounting Parts

D. R1523-36P	Mounting screw	park	4.06 ☼
" R1523-36	Mounting screw	cad	4.06 ☼
" R1523-36C	Mounting screw	chrome	5.63 ☼
" C2098-2	Phillips head screws (2)	cad	9.06 ☼
" C2097-2	Phillips head screws (2)	chrome	12.19 ☼
" C7114-2	Acorn head screws (2)	chrome	15.00 ☼
" C8444-2	Cap head screws (2)	chrome	15.00 ☼
" C8753-2	Allen head screws (2)	chrome	12.50 ☼
C9681-7	Strap mounting kit	park	21.25 ☼
C8214-7	Strap mounting kit	cad	21.25 ☼
E. R1528-36C	Strap, generator	chrome	n.a.
F. R1529-30P	Washer, strap	park	2.06 ☼
" R1529-30	Washer, strap	cad	2.06 ☼
G. 058	Screw, strap		3.00 ☼
H. R0370P	Lockwasher	park	0.50 ☼
" R0370	Lockwasher	zinc	0.30 ☼
I. R0117P	Nut, strap	park	1.19 ☼
" R0117M	Nut, strap	cad	1.25 ☼
" R0117C	Nut, strap	chrome	0.94 ☼
J. R0259P	Lockwasher	park	0.25 ☼
" R0259	Lockwasher	zinc	0.25 ☼
" R0259C	Lockwasher	chrome	0.38 ☼

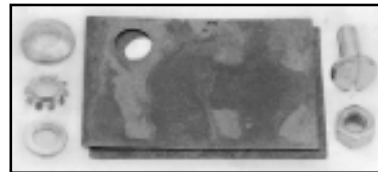
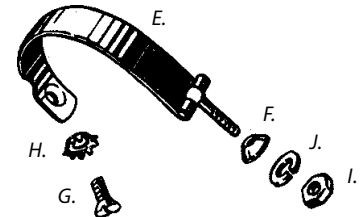

C8214-7

M1421T	Tap, 1/4"-24 (mounting screws)		7.00 ☼
Heli-Coil® thread repair			
H5540-4	Heli-Coil thread repair kit	1/4"-24	125.00 ☼
Thread repair kit includes tap, 12 inserts and installation tool.			
HR389-4	Set Heli-Coil inserts	(12)	25.00 ☼
M6117D	Drill, use with kit	17/64"	n.a. ☼

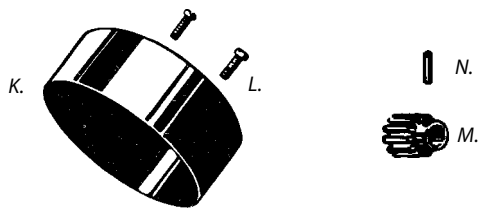

K. 1696-32	Cover, commutator	black	n.a.
" R1696-32C	Cover, commutator	chrome	n.a.
L. R037P	Screw	park	0.63 ☼
" R037	Screw	cad	0.69 ☼
" R037C	Screw	chrome	1.13 ☼
M. R632-30	Gear		n.a.
N. R634-32	Pin, generator gear		n.a.

Relay, use with 32E three brush generator '32-'57. (V-Tronic)

R4785-38	Relay, without cover		45.00
R4786-38DR	Cover	black	14.00
R4786-38DRC	Cover	chrome	16.50
R051P	Mounting screw	park	1.44 ☼
R051	Mounting screw	cad	1.50 ☼
R051C	Mounting screw	chrome	2.63 ☼

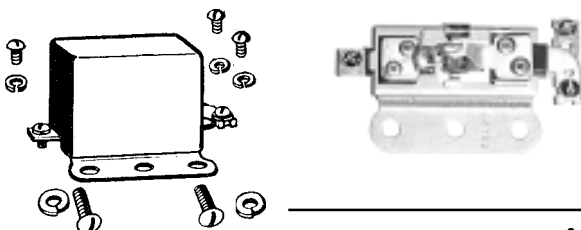

Special electronic regulator designed to convert from three-brush to two-brush generators '32-'57 models.

Without cover. (V-Tronic)			
R8375-47	Voltage regulator	6V	99.00
R8375-32	Voltage regulator	12V	99.00
R4786-38DR	Cover	black	20.00
R4786-38DRC	Cover	chrome	21.00

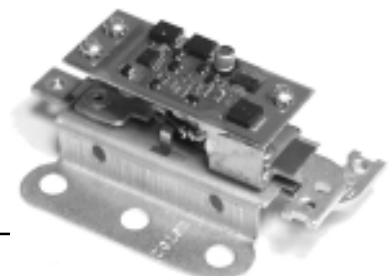

'32-'57 32E Model Generator Parts

A.	1504-32M	Frame, includes field coils	n.a.
B.	1505-32	End, frame	n.a.
C.	R1506-32	Screw, frame 12-24	8.13 ☼
	H5521-1	Heli-Coil repair kit 12-24 thread	57.00 ☼
D.	R1507-32	Field coil, shunt white dot	32.00
E.	R1508-32	Field coil, regulating orange dot	32.00
	R1509-64	Field coil set 12 Volt (for use with 12 Volt armature in 32E housing)	63.00
F.	R010Z	Screw	0.30
G.	1512-18	Screw, pole shoe	3.00 ☼
"	R1512-18	Screw, pole shoe	2.06 ☼
H.	R037	Screw, retainer cad	0.69 ☼
I.	R1636-32	Armature, 6V	n.a.
J.	R1637-46	Oil seal, armature	2.20
"	1637-46	Oil seal, armature metal O.D.	7.00 ☼
L.	1641-30A	Oil retainer, inner	7.00 ☼
M.	1641-33	Oil retainer, outer	7.00 ☼
N.	R1642-29	Armature end washer, bakelite	3.75 ☼
O.	R1642-30	Gasket, bearing housing	1.30 ☼
P.	R1643-29	Washer .033"	0.80 ☼
"	R1643-29S	Washer .070"	0.80 ☼
"	1643-30	Washer .072"	2.00 ☼
R.	R1644-18	Bearing, small	10.00
S.	R1644-30	Bearing, large	11.00
T.	R1646-31	Oil deflector	9.00 ☼
U.	1647-29A	Spring ring, bearing plate	2.00 ☼
V.	1647-31A	Rivet, bearing housing	0.50 ☼
W.	1647-31B	Spring, drive end	4.00 ☼
"	R1647-31B	Spring, drive end	1.00
X.	1647-32	Housing, drive end bearing ('32-'47)	17.00 ☼
"	1647-49	Housing, drive end bearing ('48-'57)	25.00 ☼
	R1660-32	Positive brush holder assembly	n.a.
Y.	1661-32	Holder, main brush	12.00 ☼
Z.	1662-32	Holder, third brush	n.a. ☼
F.	R010Z	Screw	0.30
AM.	R1663-32	Insulation, positive brush holder	0.85
AP.	R1663-32A	Insulation, field coil terminal	0.60
AA.	R1664-32	Screw, positive terminal	6.25 ☼
AB.	R1664-32A	Terminal screw with fittings	10.21 ☼
AC.	R1665-32	Bushing	1.88 ☼
AD.	R1666-32	Washer, insulating	1.75 ☼
AE.	R0354	Lockwasher	0.20 ☼
AF.	0105cop	Nut, terminals 10-32 copper	0.70 ☼
	M6131DI	Die, 10-32 thread	n.a. ☼
AG.	1697-30	Gasket	1.00 ☼
AH.	R036	Screw, terminal cad	0.69 ☼
AI.	1667-32	Nut, brush holder	1.50 ☼
AJ.	1669-32A	Brushes, set (3) '32-early'51	20.00 ☼
"	R1669-32A	Brushes, set (3) '32-early'51	10.00
"	R30425-51	Brushes, set (3) late'51-'57	8.00
"	R30425-51.5pack	5 Brush sets	31.00
	30450-51A	Brush with spring(1) late'51-'57	8.00 ☼
AK.	R1674-26	Spring only, third brush	1.00
"	R1674-32	Spring only, main brush	1.00

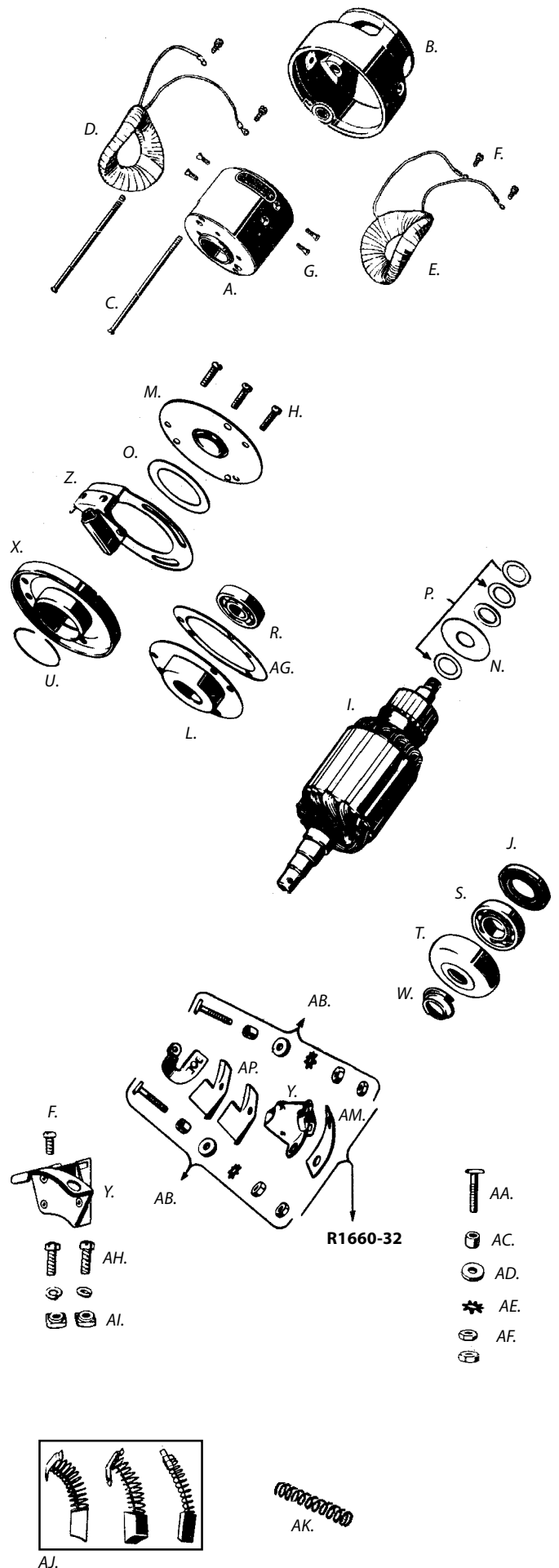

Circuit Breaker (Timer)

A.	1541-36	Gasket, timer base	'36-'64	1.00	✳
"	R1541-36	Gasket, timer base	'36-'64	0.50	
"	R1541-36.10pack	10 Timer base gaskets		3.50	
B.	1542-36	Bushing, timer shaft	'36-'69	15.00	✳
C.	1547-36	Gear, timer shaft	'36-'69	20.00	✳
"	R1547-36	Gear, timer shaft	'36-'69	7.00	
D.	1548-36	Pin, timer shaft	'36-'65	1.00	✳
E.	32535-48	Thrust washer .062"	'36-'69	4.50	✳
"	R32535-48	Thrust washer .062"	'36-'69	2.50	✳
"	32536-48	Thrust washer .066"	'36-'69	4.50	✳
"	R32536-48	Thrust washer .066"	'36-'69	2.50	✳
"	32537-48	Thrust washer .072"	'36-'69	4.50	✳
"	R32537-48	Thrust washer .072"	'36-'69	2.50	✳
"	32538-48	Thrust washer .076"	'36-'69	n.a.	✳
"	R32538-48	Thrust washer .076"	'36-'69	2.50	✳
"	R32538-KIT	Set of 4 washers .062"-.076"	'36-'69	9.00	✳
F.	R1567-36C	Cover chrome	'36-'64	14.00	
G.	R1568-36A	Retainer, base	'36-'64	10.00	
H.	R1568-36	Retainer, cover cad	'36-'64	4.00	
"	R1568-36C	Retainer, cover chrome	'36-'64	4.50	
I.	R30605-48	Points set, breaker	'49-'69	4.00	
"	R30605-48.10pack	10 Breaker points sets		31.00	
	30505-47	Circuit breaker stud	'49-'69	12.00	✳
	C8849-2	Circuit breaker stud & tool	'49-'69	12.50	✳
J.	R30507-47A	Eccentric screw	'47-'63 & '65	11.81	✳
	32669-47	Lock screw	'47-'63 & '65	n.a.	✳
	32669-63	Lock screw	'63-'64	4.00	✳
K.	32661-70	Points set, breaker	'70-'77	27.00	
"	R32661-70	Points set, breaker	'70-'77	5.00	
		(early timers are sometimes altered to accept this style points)			
	R1615-49	Timer stud		6.25	✳
	R1615-36A	Insulating washer		1.88	✳
L.	R1618-30	Washer fibre	'36-'69	1.88	✳
M.	R0201A	Washer brass		0.50	✳
N.	R0252	Lockwasher zinc		0.20	✳
O.	R0103Z	Nut zinc		0.40	✳
P.	R1629-47	Condenser	'49-'77	3.00	
"	R1629-47.10pack	10 Condensers	'49-'77	24.00	
	R1578-47	Adjusting screw	'47-'64	12.50	✳
	R1579-47	Plate, adjusting screw	'47-'63	17.50	✳
	R1613-30A	Wire, circuit breaker to coil	'48-'60	18.50	✳
	1614-18	Terminal and eyelet, circuit breaker wire		3.00	✳
	C2542-10	Wire with stud and insulators	'37-'48	31.25	✳
	C2543-10	Wire with stud and insulators	'49-'63	30.00	✳
T.	R9957	Clip, control coil cad	'50-'64	8.13	✳
U.	R4726-47	Bracket, control cad	'47-'53	n.a.	✳
W.	1123-29	Bolt, fastening park	'36-'65	1.50	✳
"	R1123-29	Bolt, fastening cad	'36-'65	3.13	✳
"	R1123-29C	Bolt, fastening chrome	'36-'65	4.06	✳
X.	R0256P	Lockwasher park		0.25	✳
"	R0256	Lockwasher zinc		0.25	✳
"	R0256C	Lockwasher chrome		0.38	✳

Timer Mounting Kits

include 2 timer fastening bolts and 3 relay mounting screws

	C9684-10	Mounting kit park	'36-'65	10.94	✳
	C8146-10	Mounting kit cad	'36-'65	11.25	✳
	C8145-10	Mounting kit chrome	'36-'65	17.50	✳
	C7130-10	Mounting kit acorn	'36-'65	18.75	✳
	C8446-10	Mounting kit cap	'36-'65	18.75	✳

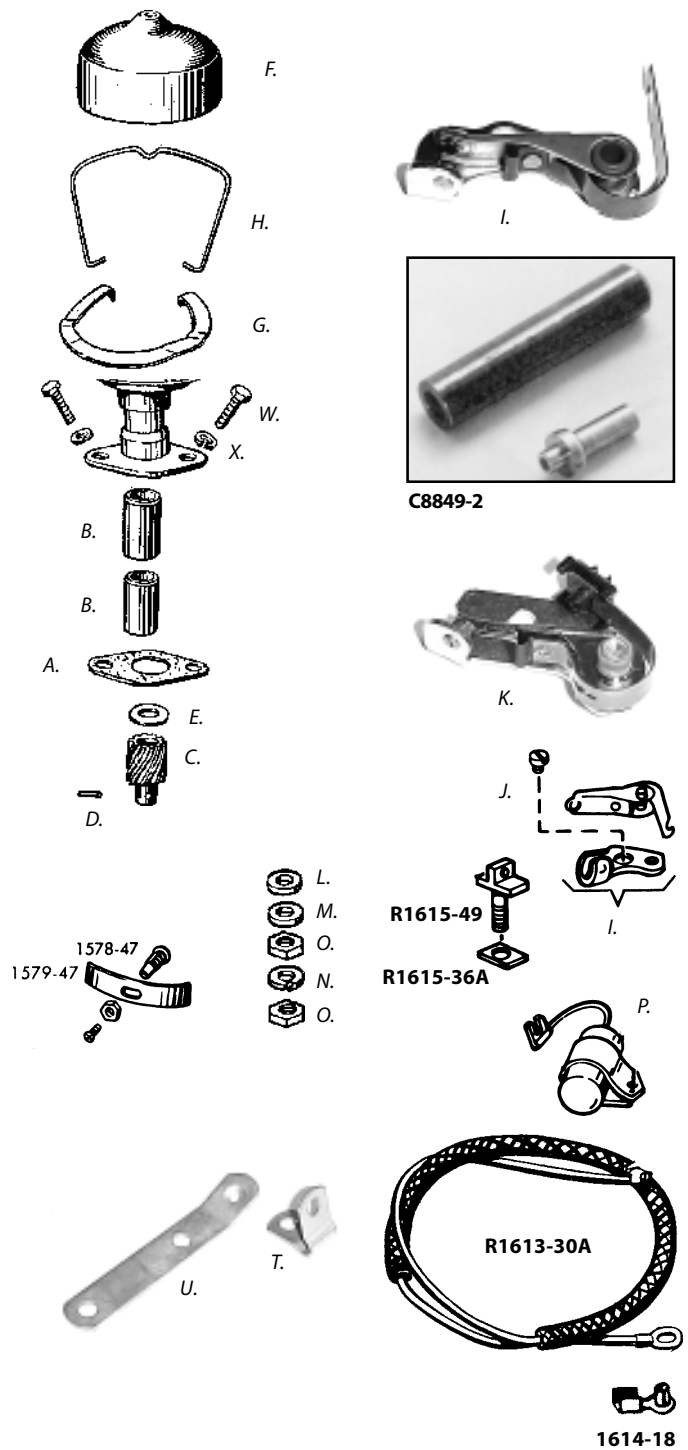

C8145-10

R4726-37 Wire clip cad 4.00 ✳
Holds timer to coil wire to crankcase bolt.

Electronic Timer, "V-Tronic"
Replaces points and condenser. Includes hardware and instructions.

R1569-77	'37-'48 models	125.00
R1569-64	w/auto advance	155.00
R1569-77A	'49-'60 models	145.00
R1569-64A	w/auto advance	160.00

Spark Coils, with cables, '48-'60

A.	R1722-29K6	Round model	6 Volt black	34.00
"	R1722-29K6.5pack	5 Coils with cables		145.00
"	R1722-29K6.10pack	10 Coils with cables		255.00

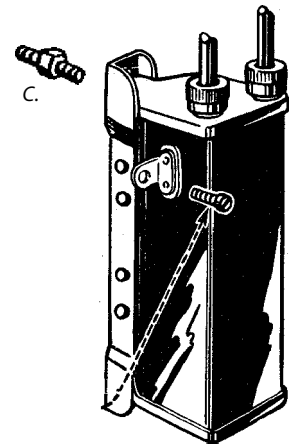

C.	4592-48	Stud, coil mounting	cad '48-'55	6.00 ☺
	R4593-48	Insulating gasket	'48-'69	7.50 ☺
	C8823-10	Coil mounting stud kit	cad '48-'55	14.38 ☺
	C8824-8	Coil mounting stud kit	cad '56-'82	15.63 ☺
	C8005-12	Terminal box assembly (with coil mounting studs and nuts)	'48-'69	66.25 ☺

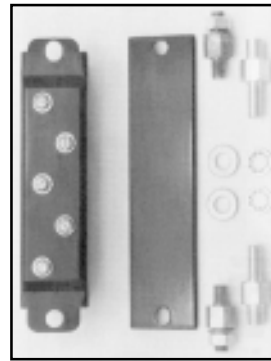

C8823-10

C8005-12

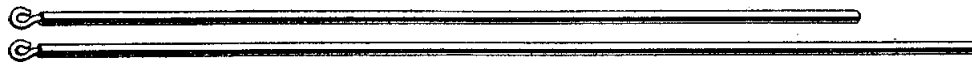

F.

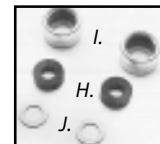

C7804-6

F.	R1596-32	Kit, plug cable (hooked ends)	'48-'55	n.a.
	R1596-30	Spark plug cable, rubber	per meter	6.00
H.	R1599-27	Cable packing seal	rubber '48-'60	2.50 ☺
I.	R1599-27A	Cable packing nut	cad '48-'60	8.75 ☺
J.	R0211P	Washer	park '48-'60	0.63 ☺
	C7804-6	Set nuts & washers	cad '48-'60	22.50 ☺
	31613-61	Connector, dual coils	'61-'64	3.00 ☺
K.	R4726-36	Clip, front spark plug cable	cad	6.25 ☺

(fits on top motor mount)



K.



L.

Spark Plugs

L.	32305-48A	Spark plug	No. 2	7.00 ☺
"	32339-04	Spark plug	No. 3 (standard)	8.00 ☺
"	32337-04	Spark plug	No. 3-4	n.a. ☺
"	32307-58	Spark plug	No. 5	7.00 ☺

Heli-Coil® thread repair

To repair stripped spark plug hole threads 14mm thread
Kit includes piloted tap, installation tool and 30 inserts.

H5523-14	Thread repair kit		165.00 ☺
HR512	Set inserts only (6)	3/8" reach	17.50 ☺



Transmission; Starter

A.	R2092-16C	Starter pedal	chrome/black rubbers	n.a.
B.	R33175-16A	Starter pedal (no logo)	black	15.00
	33182-63A	Rubber only	"Harley-Davidson"	32.00 ☼
	R33182-63	Rubber only (no logo)		6.00
	R33182-63.5pack	5 Rubbers (no logo)		24.00
C.	R2092-17	Rubber, pedal	black	10.00 ☼
"	R2092-17BL	Rubber, pedal	blue	5.00
"	R2092-17G	Rubber, pedal	green	5.00
"	R2092-17R	Rubber, pedal	red	5.00
	R2093-17P	Rod, pedal rubber	park	10.00 ☼
	R2093-17	Rod, pedal rubber	cad	10.00 ☼
Z.	R2095-16	Pedal axle	park	30.00 ☼
ZA.	R2096-17P	Pedal axle cover	park	8.13 ☼
"	R2096-17	Pedal axle cover	cad	8.13 ☼
E.	R2099-29P	End cover	park	12.50 ☼
"	R2099-29	End cover	cad	12.50 ☼
F.	R0104P	Nut 10-24	park	0.50 ☼
"	R0104Z	Nut 10-24	zinc	0.40 ☼
"	R0104C	Nut 10-24	chrome	0.50 ☼
G.	R0254P	Lockwasher	park	0.25 ☼
"	R0254	Lockwasher	zinc	0.20 ☼
"	R0254C	Lockwasher	chrome	0.38 ☼
H.	2100-41	Bolt, pedal pin "1035 cp"	park	10.00 ☼
"	R2100-41	Bolt, pedal pin	zinc	1.00 ☼
"	R2100-41C	Bolt, pedal pin	chrome	1.50 ☼
I.	R2101-31	Bushing, pedal pin bolt		1.00
J.	R2102-30	Spring washer, pedal pin bolt		0.70

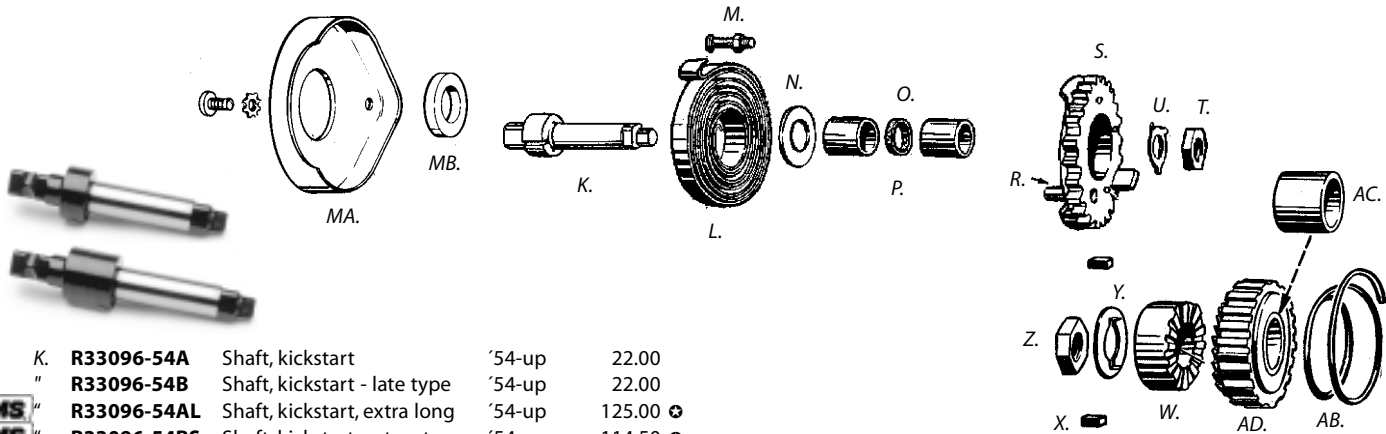
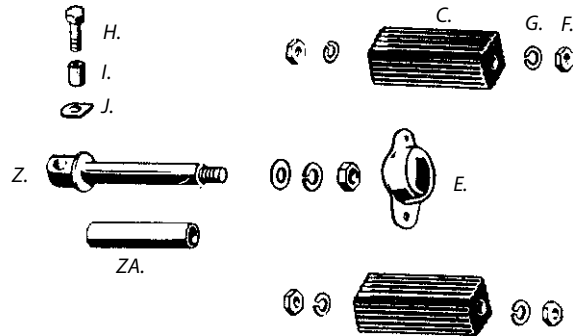
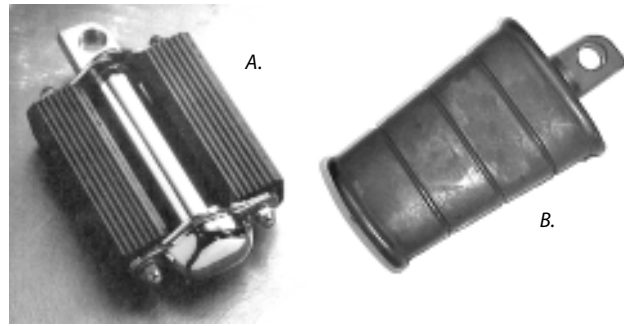

K.	R33096-54A	Shaft, kickstart	'54-up	22.00
"	R33096-54B	Shaft, kickstart - late type	'54-up	22.00
"	R33096-54AL	Shaft, kickstart, extra long	'54-up	125.00 ☼
"	R33096-54BS	Shaft, kickstart, extra strong	'54-up	114.50 ☼
	C2894-7	Starter crank bolt kit	park	17.50 ☼
	C2895-7	Starter crank bolt kit	cad	17.50 ☼
	C2896-7	Starter crank bolt kit	chrome	18.75 ☼
L.	R2084-36	Spring, starter crank	black	13.00
"	R2084-36C	Spring, starter crank	chrome	12.00
M.	R2086-36P	Stud, starter spring	park	5.63 ☼
"	R2086-36	Stud, starter spring	cad	5.63 ☼
"	R2086-36C	Stud, starter spring	chrome	7.50 ☼
"	33152-59	Stud, starter spring (use with cover)		12.50 ☼
MA.	33150-59	Spring cover kit (includes stud)	chrome	45.00 ☼
MB.	33153-60	Insert, spring cover	park	6.00 ☼
N.	2077-36	Washer, starter crank		5.00 ☼
"	R2077-36	Washer, starter crank		3.00 ☼
O.	R2078-37	Oil seal, starter crank		0.80
P.	R2127-37A	Bushing set with seal		8.00 ☼
"	R2127-37Ao	Bushing set with O-ring	O.D. 0.940"	35.00 ☼
"	R2127-37Aos	Bushing set with O-ring	+0.005"	38.00 ☼
R.	2143-36A	Pin, crank gear		2.00 ☼
S.	R2144-36	Gear, starter crank		25.00
"	33350-36T	Gear, starter crank		85.00
T.	7911	Nut, starter crank		5.00
U.	R2080-16	Lockwasher	zinc	1.15

V.	R2132-36	Gasket, side cover		1.50 ☼
"	R2132-36.10pack	10 Side cover gaskets		11.00 ☼
"	R2132-36-X	Gasket, side cover - silicone bead		4.50 ☼
W.	R2146-39	Starter clutch		17.00
X.	2147-50	Key, starter clutch		3.50 ☼
"	R2147-50	Key, starter clutch		1.30
Y.	2149-39	Lockwasher		5.00 ☼
"	R2149-39	Lockwasher		1.15
Z.	2274-36	Nut, starter clutch		8.00 ☼
"	R2274-36	Nut, starter clutch		3.25
AB.	R2152-36	Spring, starter clutch		1.70 ☼
AC.	R2155-31A	Bushing, starter gear	O.D. 0.924"	28.00 ☼
"	R2155-31B	Bushing, starter gear	O.D. 0.907"	23.50 ☼
AD.	R2155-50	Starter gear	16T '36-'58	20.00
"	33430-50T	Starter gear	16T '36-'58	48.00
"	33430-59	Starter gear	14T '59-'66	n.a.
"	R33430-59	Starter gear	14T '59-'66	28.00

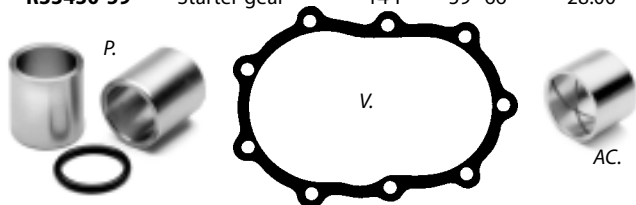

Shift bracket mounting kit

to mount bracket to frame, and jiffy stand to bracket.

C9619-18	Mounting kit, shifter	park	28.13	⊗
C9618-18	Mounting kit, shifter	cad	28.13	⊗
C9617-18	Mounting kit, shifter	chrome	33.75	⊗

A. R33638-52	Bushing, shifter lever		16.50	
B. R34609-52	Shifter rubber & stud	black	4.00	
" R34609-61	Shifter rubber & stud	white	4.50	
C. 33851-52	Shift rod	cad	n.a.	
D. 2423-30	Clevis pin, shift rod		1.00	⊗
E. R6220W	Washer, clevis pin		0.35	⊗
F. R0291	Cotter pin	zinc	0.15	⊗
G. 33871-67	Shifter rod end	zinc	10.00	⊗
" R33870-51C	Shifter rod end	chrome	17.00	
H. R2225-36P	Bolt, with nut	park	10.00	⊗
" R2225-36	Bolt, with nut	cad	10.00	⊗
" R2225-36C	Bolt, with nut	chrome	12.50	⊗

I. 34062-52	Cam follower		38.00	⊗
" R34062-52	Cam follower		9.00	
J. 34064-52	Retainer, cam follower		12.00	⊗
" R34064-52	Retainer, cam follower		9.50	
K. 34066-52	Lock washer cam follower		1.60	⊗
" R34066-52	Lock washer cam follower		0.90	
L. 34068-52A	Spring, cam follower		4.00	⊗
" R34068-52A	Spring, cam follower		1.20	
M. 2166-26	Spring, gear shifter		2.20	⊗
" R2166-26	Spring, gear shifter		n.a.	⊗
N. 33960-36A	Gear, shifter		n.a.	⊗
O. 34453-52	Shaft, shifter		35.00	⊗
" R34453-52	Shaft, shifter		22.00	
P. R34031-41	Shaft, shifter cam		17.50	⊗
R. 2244-36A	Lock screw, shifter cam shaft		8.00	⊗
" R2244-36A	Lock screw, shifter cam shaft		2.00	⊗
S. R2245-36A	Seal, cam shaft	rubber	0.90	⊗
" R2245-36A.10pack	10 Oil seals		7.00	⊗

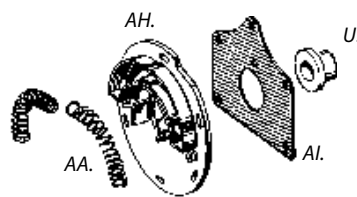
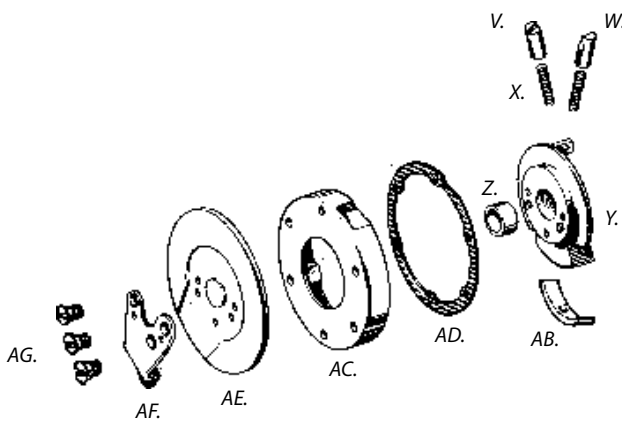
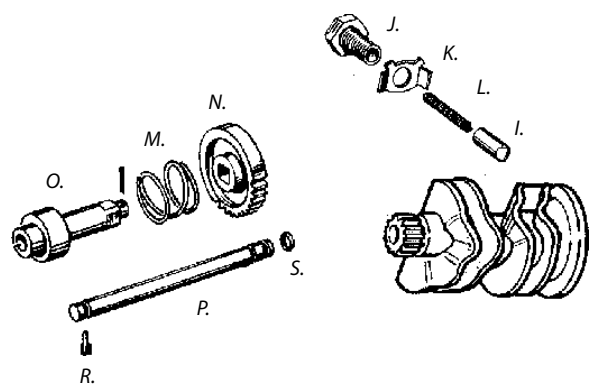
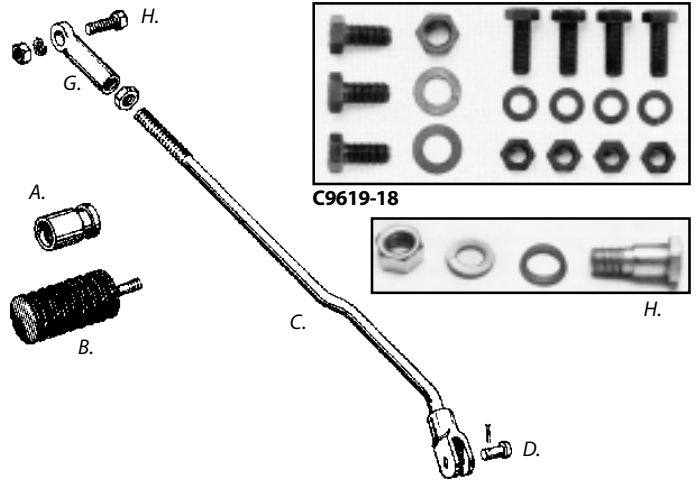

U. 34435-52	Bushing, shifter shaft		21.00	⊗
" R34435-52	Bushing, shifter shaft		17.00	
V. 34473-53	Pawl & spring, left		18.00	⊗
" 34477-53	Pawl, left		17.00	⊗
" R34477-53	Pawl, left		12.00	
W. 34474-53	Pawl & spring, right		18.00	⊗
" 34478-53	Pawl, right		22.00	⊗
" R34478-53	Pawl, right		12.00	
X. R34482-53	Spring, shifter pawl		1.00	

Y. 34488-52B	Carrier, shifter pawl		n.a.	⊗
Z. R34498-52	Bushing, pawl carrier		12.50	
AA. R34500-52A	Spring, pawl carrier		1.00	⊗
" R34500-52A.10pack	10 Pawl carrier springs		7.00	⊗
AB. 34525-54	Retainer, pawl		7.00	⊗
AC. 34551-52	Cover, shifter		32.00	⊗
" R34551-52	Cover, shifter	polished	17.00	
AD. R34552-52	Gasket, shifter cover		1.30	
" R34552-52.10pack	10 Shifter cover gaskets		9.00	
AE. 34555-52	Shield	zinc	17.00	⊗
" R34555-52C	Shield	chrome	11.00	
AF. 34447-52un	Lever, shifter shaft	not plated	n.a.	
" R34447-52C	Lever, shifter shaft	chrome	8.50	
AG. R1761W	Screw, lever	zinc	0.80	
" 34423-87T	Cover & lever set	chrome	39.00	
AH. 34560-52	Adapter plate		77.00	⊗
AI. R34565-52	Gasket, adapter plate		1.00	
" R34565-52.10pack	10 Adapter plate gaskets		7.00	
AJ. R462-11	Washer, neutral switch		0.30	

Transmission; Hand-Shifter

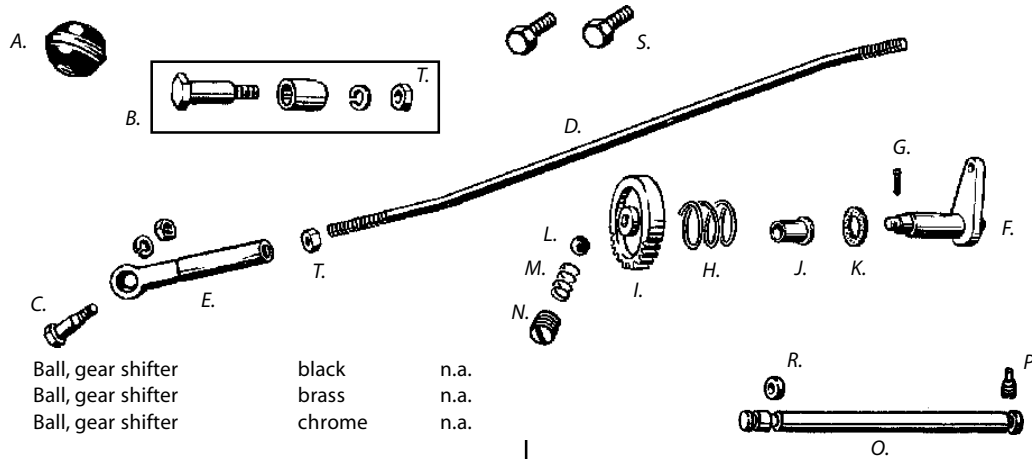

A.	2205-31	Ball, gear shifter	black	n.a.
"	R2205-31B	Ball, gear shifter	brass	n.a.
"	R2205-31C	Ball, gear shifter	chrome	n.a.
	33775-37	Stud with bushing	zinc	19.00 ☼
	2206-47	Stud, without bushing	zinc	15.00 ☼
	2207-47	Bushing, shifter lever stud		n.a. ☼
	R2207-47	Bushing, shifter lever stud		7.50 ☼
B.	R2206-37P	Stud kit	park	20.00 ☼
"	R2206-37	Stud kit	cad	20.00 ☼
"	R2206-37C	Stud kit	chrome	25.00 ☼



C.	2225-36	Bolt, shifter rod end	park	n.a. ☼
"	R2225-36P	Bolt, with nut	park	10.00 ☼
"	R2225-36	Bolt, with nut	cad	10.00 ☼
"	R2225-36C	Bolt, with nut	chrome	12.50 ☼
D.	R2213-36P	Shifter rod	'36-'50 park	n.a. ☼
"	R2213-36	Shifter rod	'36-'50 cad	n.a. ☼
"	R2213-36C	Shifter rod	'36-'50 chrome	n.a. ☼
"	R33857-51	Shifter rod	'51-'65 cad	29.00 ☼
"	R33857-51C	Shifter rod	'51-'65 chrome	30.00 ☼
E.	R2214-36P	Shifter rod end	'36-'50 park	n.a. ☼
"	R2214-36	Shifter rod end	'36-'50 cad	n.a. ☼
"	R33870-51C	Shifter rod end	'36-'66 chrome	17.00 ☼
"	R2214-36i	Shifter rod end	'36-'50 black	6.00 ☼
"	33871-67	Shifter rod end	'51-'66 zinc	n.a. ☼
"	R33870-51C	Shifter rod end	'51-'66 chrome	17.00 ☼

F.	34448-51	Lever, shifter shaft	'51-up	n.a.
"	34454-51	Lever only (repair part)	'51-up	14.00 ☼
G.	R0291	Cotter pin	zinc	0.15 ☼
H.	2166-26	Spring, gear shifter		2.20 ☼
"	R2166-26	Spring, gear shifter		n.a. ☼
I.	33960-36A	Gear, shifter		n.a. ☼
J.	R2242-36C	Bushing, shifter shaft		16.00 ☼
K.	2245-26	Washer	leather	2.00 ☼
"	R2245-26	Washer	leather	1.00 ☼
L.	R2251-36	Ball, cam plunger		1.00 ☼
M.	2251-36A	Spring, plunger ball		1.50 ☼
N.	2251-36B	Cam plunger cap screw	park	15.00 ☼
"	R2251-36B	Cam plunger cap screw	park	n.a.
	C9983-3	Shifter cam plunger kit		25.62 ☼
	R462-11	Washer, neutral switch		0.30 ☼
O.	2244-36	Shaft, shifter cam		21.00 ☼
"	R2244-36	Shaft, shifter cam		16.50 ☼
P.	2244-36A	Lock screw, shafts		8.00 ☼
"	R2244-36A	Lock screw, shafts		2.00 ☼
R.	R2245-36A	Oil seal, shafts		0.90 ☼
"	R2245-36A.10pack	10 Oil seals		7.00 ☼
S.	R054WZ	Bolt, shift guide	zinc	0.50 ☼
"	R054WC	Bolt, shift guide	chrome	1.30 ☼
T.	R0117P	Nut	park	1.19 ☼
"	R0117M	Nut	cad	1.25 ☼
"	R0117C	Nut	chrome	0.94 ☼
U.	R0259P	Lockwasher	park	0.25 ☼
"	R0259	Lockwasher	zinc	0.25 ☼
"	R0259C	Lockwasher	chrome	0.38 ☼

Handshift and Footshift

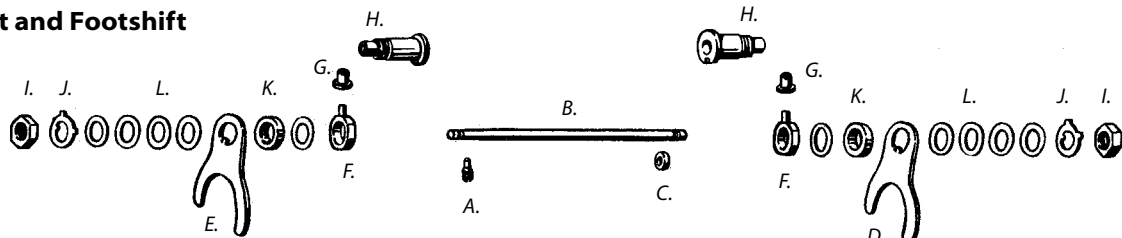

A.	2244-36A	Lock screw, shafts		8.00 ☼
"	R2244-36A	Lock screw, shafts		2.00 ☼
B.	R2245-36	Shaft, shifter fork		13.50 ☼
"	R2245-36.5pack	5 Shifter fork shafts		55.00 ☼
C.	R2245-36A	Oil seal, shafts		0.90 ☼
"	R2245-36A.10pack	10 Oil seals		7.00 ☼
D.	R2246-36	Shifting fork, mainshaft		7.00 ☼
E.	R2247-36	Shifting fork, countershaft		7.00 ☼
"	2247-39	Shifting fork, countershaft, 3+reverse		65.00 ☼
F.	R2248-36	Finger, shifting		13.50 ☼
G.	2248-39	Roller, shifter finger		n.a. ☼
"	R2248-39	Roller, shifter finger		1.50 ☼

H.	2249-36	Bushing, shifter fork		n.a. ☼
"	R2249-36	Bushing, shifter fork		12.50 ☼
I.	2250-33	Nut, shifter fork bushing		n.a. ☼
"	R2250-33	Nut, shifter fork bushing		3.00 ☼
"	34179-33T.10pack	10 Shifter fork bushing nuts		20.00 ☼
J.	2251-33	Lockwasher		2.00 ☼
"	R2251-33	Lockwasher		1.15 ☼
K.	2253-33	Washer	.083"	2.00 ☼
"	R2253-33	Washer	.093"	1.25 ☼
L.	R2253-33A	Shim, spacer	.014"	0.80 ☼
"	R2253-33B	Shim, spacer	.007"	0.80 ☼

Transmission; Hardware

A.	R2318-36	Mounting stud	3/8"-16	standard	5.31 ☼
	C9653-4	Set bottom studs	3/8"-16	standard	21.88 ☼
"	R2318-36B	Mounting stud	7/16"-14	oversize	5.31 ☼
"	R2318-47	Mounting stud	1/2"-13	oversize	5.63 ☼
B.	R2318-36AP	Nut, mounting stud		park	1.63 ☼
"	R2318-36A	Nut, mounting stud		cad	1.69 ☼
"	R2318-36AC	Nut, mounting stud		chrome	1.88 ☼
C.	R0223AP	Washer		park	1.13 ☼
"	R0223A	Washer		cad	1.13 ☼
"	R0223AC	Washer		chrome	1.38 ☼
D.	R0261P	Lockwasher		park	0.25 ☼
"	R0261	Lockwasher		zinc	0.25 ☼
"	R0261C	Lockwasher		chrome	0.38 ☼
E.	R2263-36BP	Bolt, mounting		park	2.19 ☼
"	R2263-36B	Bolt, mounting		cad	1.85 ☼
"	R2263-36BC	Bolt, mounting		chrome	2.25 ☼
F.	2328-36	Screw, adjusting	'36-'64	park	20.00 ☼
"	R2328-36P	Screw, adjusting	'36-'64	park	16.25 ☼
"	R2328-36	Screw, adjusting	'36-'64	cad	16.56 ☼
"	R2328-36C	Screw, adjusting	'36-'64	chrome	18.75 ☼
H.	R2265-36P	Vent nipple	'36-'55	park	4.06 ☼
"	R2265-36	Vent nipple	'36-'55	cad	4.06 ☼
"	R2265-36C	Vent nipple	'36-'55	chrome	5.00 ☼
I.	34720-56	Vent screw	'56-'78	zinc	11.00 ☼
"	R34720-56	Vent screw	'56-'78	cad	5.00 ☼
"	R34720-56C	Vent screw	'56-'78	chrome	5.63 ☼

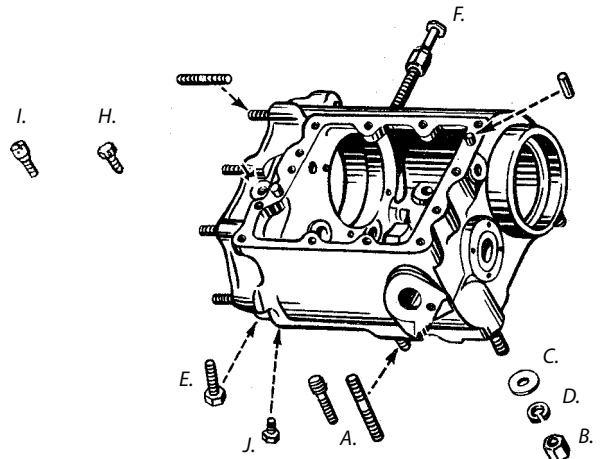

J.	453-11	Drain plug	3/8"-24	park	6.00 ☼
"	R453-11P	Drain plug	3/8"-24	park	4.38 ☼
"	R453-11	Drain plug	3/8"-24	cad	4.38 ☼
"	R453-11C	Drain plug	3/8"-24	chrome	6.25 ☼
	R453-11SP	Drain plug, oversize	7/16"-20	park	6.25 ☼
	R453-11S	Drain plug, oversize	7/16"-20	cad	6.25 ☼
	R453-11SC	Drain plug, oversize	7/16"-20	chrome	6.88 ☼
"	C8495-1	Drain plug w. washer	1/2"-13	cad	7.50 ☼
"	C8494-1	Drain plug w. washer	1/2"-13	chrome	10.00 ☼
	R62702-52	Washer, drain plug	(fits 1/2" plug)		1.75 ☼

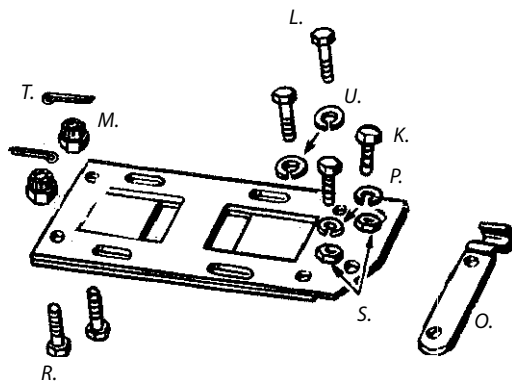

K.	R064P	Bolt	park	1.81 ☼	R.	R075P	Bolt	park	5.63 ☼
"	R064	Bolt	cad	1.88 ☼	"	R075	Bolt	cad	5.63 ☼
"	R064C	Bolt	chrome	2.13 ☼	"	R075C	Bolt	chrome	6.25 ☼
L.	R079P	Bolt	park	4.06 ☼	S.	R0117P	Nut	park	1.19 ☼
"	R079	Bolt	cad	4.19 ☼	"	R0117M	Nut	cad	1.25 ☼
"	R079C	Bolt	chrome	4.81 ☼	"	R0117C	Nut	chrome	0.94 ☼
M.	R0128P	Nut	park	2.00 ☼	T.	R0291P	Pin	park	0.19 ☼
"	R0128	Nut	cad	2.13 ☼	"	R0291	Pin	zinc	0.15 ☼
"	R0128C	Nut	chrome	2.31 ☼					
O.	R2804-36AP	Support, adjusting screw	park	12.00					
"	R2804-36A	Support, adjusting screw	cad	21.88 ☼					
"	R2804-36AC	Support, adjusting screw	chrome	26.25 ☼					
P.	R0259P	Lock	park	0.25 ☼	U.	R0261P	Lock	park	0.25 ☼
"	R0259	Lock	zinc	0.25 ☼	"	R0261	Lock	zinc	0.25 ☼
"	R0259C	Lock	chrome	0.38 ☼	"	R0261C	Lock	chrome	0.38 ☼

Transmission Mounting Kits

Kits include all nuts, bolts, washers to mount transmission to plate and plate to frame. '36-'64 kits also include adjusting screw.

C9695-26	Stock kit	'36-'64	park	62.50 ☼
C8232-26	Stock kit	'36-'64	cad	62.50 ☼
C8231-26	Stock kit	'36-'64	chrome	65.00 ☼
C7602-11	Transm. to plate kit	'36-'64	chrome acorn	36.88 ☼
C7800-8	Plate to frame kit	'36-'64	chrome acorn	28.75 ☼
C9419-19	Stock kit	'65-'76	zinc	40.00 ☼
C9418-19	Stock kit	'65-'76	chrome	44.38 ☼



C8232-26

COLONY

Transmission; Hardware

Side Cover Studs and Nuts

A.	R2134-36	Stud, starter cover	1-3/8"	1.88 ☼
"	R33298-65	Stud, starter cover, longer	1-1/2"	3.00 ☼
"	R24818-52	Stud, starter cover, longer	1-11/16"	6.25 ☼
"	R33299-65	Stud, starter cover, longer	1-3/4"	3.75 ☼
	C9637-13	Set studs (13) park	'36-'84	19.38 ☼
	C3144-13	Set studs (13) cad	'36-'84	19.38 ☼
B.	R0117P	Nut "machined" park		1.19 ☼
"	R0117M	Nut "machined" cad		1.25 ☼
"	R0117C	Nut chrome		0.94 ☼
C.	R6316WP	Washer park		0.31 ☼
"	R6316W	Washer cad		0.38 ☼
"	R6316WC	Washer chrome		0.50 ☼

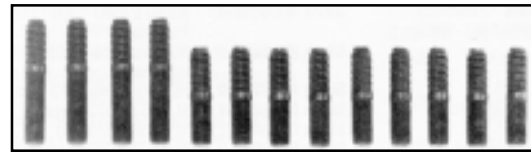
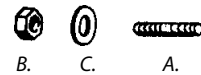

C9637-13

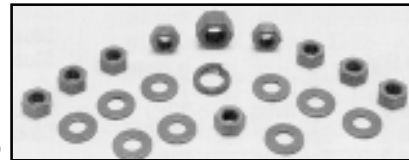

C9671-20



C7112-19

Side Cover Nut Kits

Kits include 9 side cover nuts with washers and the clutch arm nut.

	C9671-20	Stock nuts park		10.94 ☼
	C8113-20	Stock nuts cad		11.25 ☼
	C8112-20	Stock nuts chrome		16.25 ☼
	C7112-19	Acorn style chrome		28.75 ☼
	C8442-19	Cap style chrome		30.00 ☼
	C8751-19	Long acorn style chrome		31.25 ☼
	C8752-19	Long cap style chrome		31.25 ☼
	C8820-9	Allen screws chrome		23.75 ☼
	C8820-9-P	Polished Allen screws chrome		25.00 ☼

Transmission Filler Plugs

	R2326-36P	Stock plug '36-'57 park		11.25 ☼
	R2326-36	Stock plug '36-'57 cad		11.88 ☼
	R2326-36C	Stock plug '36-'57 chrome		16.25 ☼
	C9401-1	Stock plug '58-'80 aluminum		16.88 ☼
	C9400-1	Stock plug '58-'80 chrome		19.38 ☼
	C7351-2	Custom style chrome		17.50 ☼
	C8801-2	Custom cap style chrome		17.50 ☼

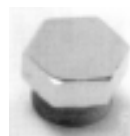

R2326-36C



C9400-1



C7351-2



C8801-2

Self tapping oversize plugs, to repair stripped threads

	C8407-1	Stock plug oversize cad		13.75 ☼
	C8406-1	Stock plug oversize chrome		18.75 ☼
	C7156-2	Custom style oversize chrome		17.50 ☼



Transmission Top Cover Screws



D.	R2268-36P	Screw, top cover short park		1.25 ☼
"	R2268-36	Screw, top cover short cad		1.44 ☼
"	R2268-36C	Screw, top cover short chrome		1.88 ☼
E.	R1523-32P	Screw, top cover long park		3.75 ☼
"	1523-32CAD	Screw, top cover long cad		3.50 ☼
"	R1523-32	Screw, top cover long cad		3.75 ☼
"	R1523-32C	Screw, top cover long chrome		5.00 ☼
F.	R2265-36P	Vent nipple '36-'55 park		4.06 ☼
"	R2265-36	Vent nipple '36-'55 cad		4.06 ☼
"	R2265-36C	Vent nipple '36-'55 chrome		5.00 ☼
G.	34720-56	Vent screw '56-'78 zinc		11.00 ☼
"	R34720-56	Vent screw '56-'78 cad		5.00 ☼
"	R34720-56C	Vent screw '56-'78 chrome		5.63 ☼

Transmission Top Cover Screw Kits

Kits include 10 short screws, 2 long screws and a vent screw.

	C9620-13	Screw kit, slotted park	'36-'49	20.00 ☼
	C9613-13	Screw kit, slotted cad	'36-'49	20.00 ☼
	C9612-13	Screw kit, slotted chrome	'36-'49	27.50 ☼
	C2104-13	Screw kit, Phillips cad	'50-'55	27.19 ☼
	C2103-13	Screw kit, Phillips chrome	'50-'55	30.00 ☼
	C8148-13	Screw kit, slotted cad	'56-'64	22.50 ☼
	C8147-13	Screw kit, slotted chrome	'56-'64	28.75 ☼
	C8750-14	Screw kit, Allen chrome	'56-'64	34.38 ☼
	C8749-12	Screw kit, Allen cad	'65-'79	28.13 ☼
	C8748-12	Screw kit, Allen chrome	'65-'79	34.38 ☼



M1421T	Tap	1/4"-24 for top cover screws	7.00 ☼
---------------	-----	------------------------------	--------

Heli-Coil® thread repair, 1/4"-24 thread

H5540-4	Heli-coil repair kit for top cover screws	125.00 ☼
(includes 12 inserts, tap and installation tool, order drill separately)		
HR389-4	Set Heli-coil inserts only (12)	25.00 ☼
M6117D	Drill, use with repair kit 17/64"	n.a. ☼

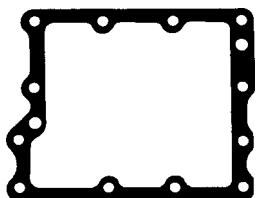

2261-36	Gasket, cover	5.00 ☼
R2261-36	Gasket, cover	1.50 ☼
R2261-36.10pack	10 Gaskets	11.00 ☼

- R2200-36** Transmission gasket set 14.00 ☉ (does not include gaskets for the foot shift top cover)
- R33031-70** Transmission gasket set James Gaskets 51.00 ☉ (complete set, covers all 3-speed and 4-speed transmissions)

Transmission Rebuild Kit

- R33031-36KIT** Rebuild kit '36-early'76 420.00 ☉

- Kit includes :
- Countershaft
 - Main drive gear bearing race (standard size)
 - Main drive gear bushing
 - Shifter fork shaft
 - Gear bushings
 - All lockwashers etc.
 - Complete gasket and seal set

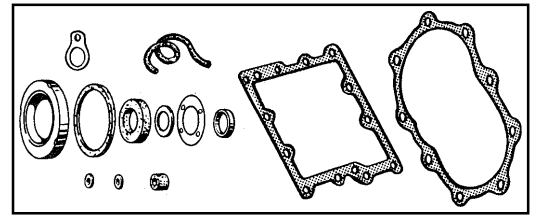
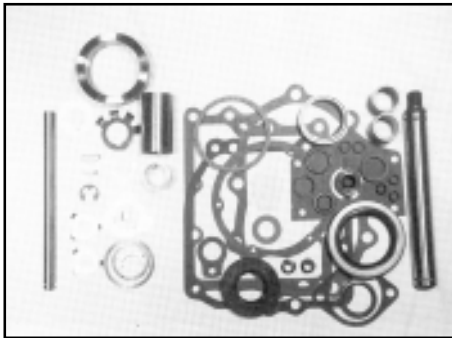

Main Drive Gear

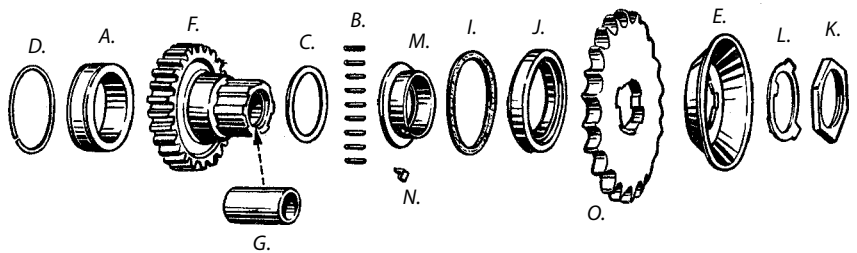

Transmission main bearing race

- Standard race O.D. is 2.314"
- Standard race I.D. is 1.8802"

- A. **R2284-37** Bearing race Standard **Eastern Parts** 49.00 ☉

- JIMS** " **R2284-37jims** Bearing race Standard 110.00 ☉
- JIMS** " **R2284-37.002** Bearing race Oversize O.D. +.002" 112.00 ☉
- JIMS** " **R2284-37.005** Bearing race Oversize O.D. +.005" 112.00 ☉
- JIMS** " **R2284-37.010** Bearing race Oversize O.D. +.010" 112.00 ☉

- D. **2284-36A** Retaining ring 9.50 ☉
- " **R2284-36A** Retaining ring 1.50 ☉
- E. **R2290-39** Oil deflector 12.00 ☉
- F. **R35065-65B** Main drive gear '38-'65 85.00
- G. **R35094-65** Bushing early style **JIMS** 38.50 ☉
- " **R2297-31** Bushing early style 25.00 ☉
- " **R35094-65A** Bushing late style 9.00
- R12013A** Oil seal, main drive gear 2.50

Roller, main drive gear - also available in 100-packs

- B. **R2289-36** Standard .125"x.615" 0.30 ☉
- " **R2289-36F** O.S. +.0004" 0.30 ☉
- " **R2289-36KA** O.S. +.0008" 0.30 ☉
- " **R2289-36MA** O.S. +.0010" 0.30 ☉
- " **R2289-36MA2** O.S. +.0020" 0.30 ☉

- C. **R2290-36** Washer, thrust standard .060" 5.50 ☉
- " **R2290-36E** Washer, thrust undersize .050" 5.50 ☉
- " **R2290-36F** Washer, thrust undersize .055" 5.50 ☉
- " **R2290-36B** Washer, thrust oversize .065" 5.50 ☉
- " **R2290-36C** Washer, thrust oversize .070" 5.50 ☉
- " **R2290-36D** Washer, thrust oversize .080" 5.50 ☉
- " **R2290-36set** Washer, thrust set of 4 .060" - .080" 18.00 ☉

- I. **R2163-36B** Cork washer, oil seal 1.50 ☉
- J. **R2163-36** Oil seal, double lip 4.50 ☉
- K. **R2335-36** Locknut, sprocket 15.63 ☉
- L. **R2337-36** Washer, locknut 1.50
- M. **R2339-37** Spacer, main gear 24.00 ☉
- N. **R2339-38** Key, main gear spacer 1.50 ☉

- O. **R2035-36** Mainshaft sprocket 22 T 13.00
- " **R35212-41** Mainshaft sprocket 23 T 15.00
- " **R35213-41** Mainshaft sprocket 24 T 15.00
- " **R35214-41** Mainshaft sprocket 25 T 16.00
- " **R35215-41** Mainshaft sprocket 26 T 16.00

Transmission

Mainshaft

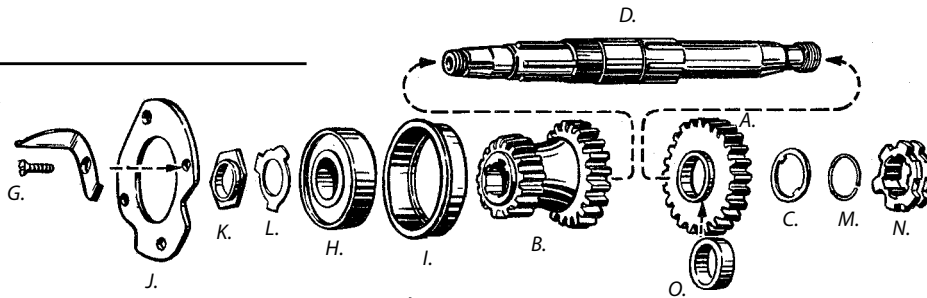

A.	2295-36	Second gear	three+reverse only	120.00	✳
"	35306-59T	Third gear 24T	4-speed '59-up	95.00	
"	R35306-59CR	Third gear 23T for close ratio set	'59-up	31.00	
B.	35282-59	Low/second gear	4-speed '59-up	195.00	✳
"	R35282-59	Low/second gear	4-speed '59-up	n.a.	
C.	2297-36A	Retaining washer	standard .063"	9.50	✳
"	R2297-36A	Retaining washer	standard .063"	4.00	✳
"	R2297-36A.048	Retaining washer	undersize .048"	4.25	✳
"	R2297-36A.053	Retaining washer	undersize .053"	4.25	✳
"	R2297-36A.058	Retaining washer	undersize .058"	4.25	✳
"	R2297-36A.068	Retaining washer	oversize .068"	4.25	✳
"	R2297-36A.073	Retaining washer	oversize .073"	4.25	✳
"	R2297-36A.078	Retaining washer	oversize .078"	4.25	✳
"	R2297-36A.083	Retaining washer	oversize .083"	4.25	✳

D.	R2272-50	Mainshaft	'38-'64	n.a.	
"	R35039-65	Mainshaft	'65-'69	n.a.	
R37436-36	Bushing, mainshaft ends			1.75	
G.	R2268-36	Screw, plate		1.44	✳
H.	R2280-36	Ball bearing		18.00	
I.	R2161-36	Housing		37.00	✳
J.	R2162-36A	Plate, retaining		14.50	
K.	2281-36A	Nut		16.00	✳
"	R2281-36A	Nut		5.00	
L.	2281-40A	Lockwasher		4.00	✳
"	R2281-40A	Lockwasher		1.25	
M.	2297-36B	Lock ring		3.20	✳
"	R2297-36B	Lock ring		0.95	
N.	2298-38A	Shifter clutch		85.00	✳
"	R2298-38A	Shifter clutch		18.00	
O.	R2299-38	Bushing	'36-'58	18.50	✳

Countershaft

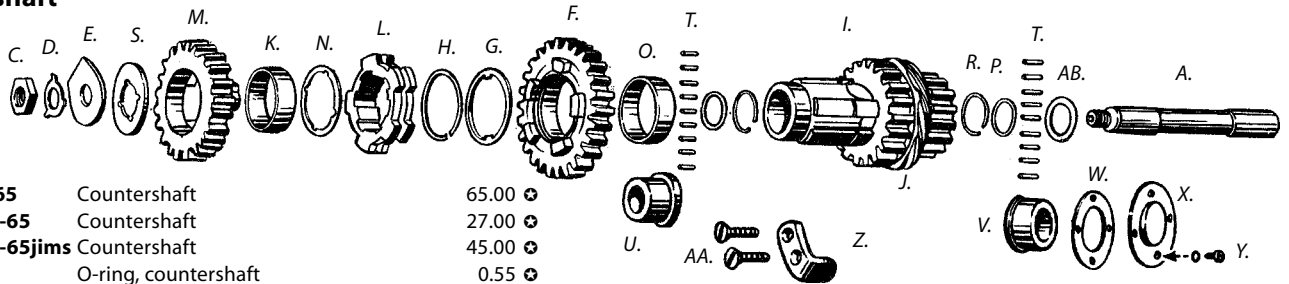

A.	35614-65	Countershaft		65.00	✳
"	R35614-65	Countershaft		27.00	✳
"	R35614-65jims	Countershaft		45.00	✳
R11115	O-ring, countershaft			0.55	✳
C.	7911	Nut		5.00	✳
D.	R2080-16	Lockwasher		1.15	
E.	2300-36A	Lockplate		3.50	✳
"	R2300-36A	Lockplate		3.45	
F.	2301-36	Countershaft second gear	21T	175.00	✳
"	35751-36T	Countershaft second gear	21T	75.00	
G.	R2302-36A	Washer, gear retaining		4.50	✳
H.	2302-36B	Spring lock ring		5.00	✳
"	R2302-36B	Spring lock ring		1.20	✳
I.	35713-36T	Countershaft gear, 4-speed	15T + 17T	225.00	✳
"	R35713-36T	Countershaft gear, 4-speed	15T + 17T	85.00	
"	35703-69	Countershaft gear, three speed+reverse		285.00	✳
(This gear has 1969-up speedo drive gear, replace with correct year gear)					
2365-36	Idler gear, three speed+reverse			85.00	✳
33237-64	Spacer, idler gear	late '64		4.00	✳
K.	R2297-36E	Bushing, low or reverse gears		7.00	
L.	R2298-36B	Shifter clutch, countershaft		19.00	
M.	2304-36	Countershaft low gear	26 T	215.00	✳
(includes bushing)					
2304-39A	Countershaft reverse gear	23 T		n.a.	✳
N.	R2304-36B	Bearing washer		3.50	✳
O.	R2304-36D	Bushing		6.50	
P.	2307-36	Retaining washer		9.00	✳
"	R2307-36	Retaining washer		3.50	✳
R.	2307-36A	Lockring, roller retaining washer		5.00	✳
"	R2307-36A	Lockring, roller retaining washer		1.50	✳
AB.	R2308-36A	Thrustwasher	standard .060"	3.60	✳
"	R2308-36A.050	Thrustwasher	undersize .050"	3.75	✳
"	R2308-36A.055	Thrustwasher	undersize .055"	3.75	✳
"	R2308-36A.065	Thrustwasher	oversize .065"	3.75	✳
"	R2308-36A.070	Thrustwasher	oversize .070"	3.75	✳

T.	R2289-36	Roller, std.	0.125" x .615"	0.30	✳
"	R2289-36F		+ .0004"	0.30	✳
"	R2289-36KA		+ .0008"	0.30	✳
"	R2289-36MA		+ .0010"	0.30	✳
Also available in 100-packs.					
U.	2314-36	Bushing, starter side		19.00	✳
"	R2314-36	Bushing, starter side		11.50	✳
"	R2314-36os	Bushing, starter side oversize +.005"		12.00	✳
V.	2314-36A	Bushing, clutch side		19.00	✳
"	R2314-36A	Bushing, clutch side		11.50	✳
"	R2314-36Aos	Bushing, clutch side oversize +.005"		12.00	✳
W.	R2307-36D	Gasket, end cap		1.10	
X.	R2307-36E	End cap, countershaft		8.50	
Y.	R016Z	Screw		0.30	
	R0351	Lockwasher		0.20	
Z.	R2145-36	Starter gear bumper plate		3.00	
AA.	1864B	Screw, bumper plate		1.00	✳
S.	R2308-36H.050	Gear end washer	.050"	4.50	✳
"	R2308-36H.055	Gear end washer	.055"	4.50	✳
"	R2308-36H.060	Gear end washer	.060"	4.50	✳
"	R2308-36H.065	Gear end washer	.065"	4.50	✳
"	R2308-36H.070	Gear end washer	.070"	4.50	✳
"	R2308-36H.074	Gear end washer	.074"	4.50	✳
"	R2308-36H.078	Gear end washer	.078"	4.50	✳
"	R2308-36H.082	Gear end washer	.082"	4.50	✳
"	R2308-36H.085	Gear end washer	.085"	4.50	✳
"	R2308-36H.090	Gear end washer	.090"	4.50	✳
"	R2308-36H.095	Gear end washer	.095"	4.50	✳
"	R2308-36H.100	Gear end washer	.100"	4.50	✳
"	R2308-36H.105	Gear end washer	.105"	4.50	✳
"	R2308-36H.110	Gear end washer	.110"	4.50	✳
"	R2308-36H.115	Gear end washer	.115"	4.50	✳
"	R2308-36H	Set gear end washers (7)	.074"- .100"	28.00	✳

Transmission Tools



R1005 Main drive gear tool 92.50 €
Use to install and remove the main drive gear bushing.



R95660-42 Transmission oil seal tool 385.00 €
Use to install and remove main seal in all '36-'76 4-speed transmissions. This tool will push the seal in as flat and straight as possible to .050" below housing for a no leak fit.

R96710-77 Transmission lapping tool 540.00 €
Use to lap main drive gear bearing race to size and in line with mainshaft roller bearing, also includes lap and pilot for Sportsters.

R96710-80 Combination kit 895.00 €
Same as above, but also includes motor case lapping tools for use on Big Twins, Sportsters and 750cc models.

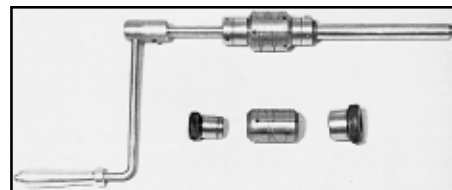

R96384-39 Shift fork tool '39-'78 175.00 €
To set and align shifter forks.

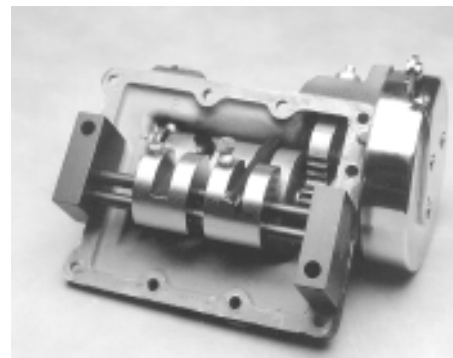

R12733-41 Socket, mainshaft nut (2281-36A) 36.00



R1050 Transmission stud installer tool 67.50 €



R1700 Mainshaft clutch gear puller 345.00 €
Pulls clutch gear from mainshaft without damage to shaft or gear. 4-speed Big Twins with kick starter.

Clutch

Foot Clutch Control

Clutch Bracket Mounting Kit

Bolts and nuts to mount bracket to frame, and jiffy stand to bracket.

C9619-18	Mounting kit	park	28.13	✚
C9618-18	Mounting kit	cad	28.13	✚
C9617-18	Mounting kit	chrome	33.75	✚

C9619-18

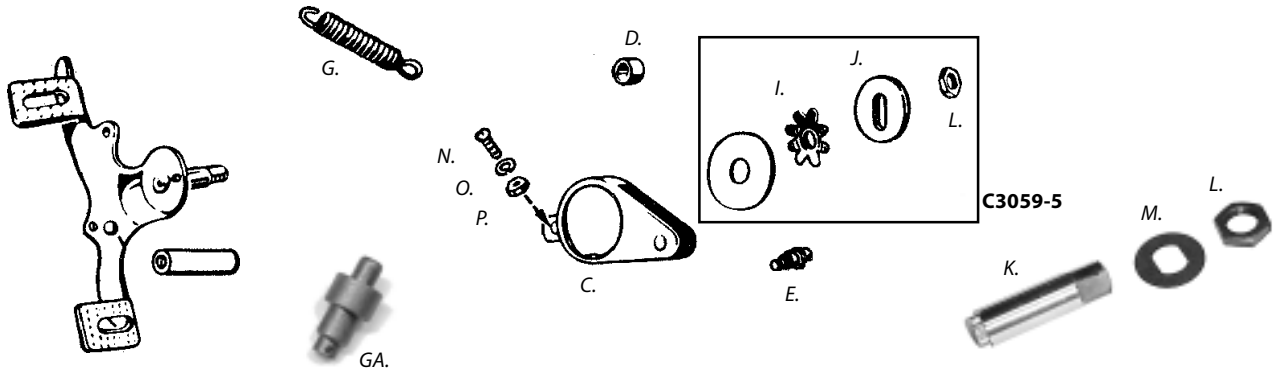
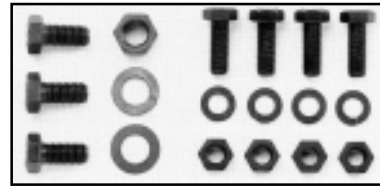

C.	R2409-36BC	Cover, foot lever	chrome	n.a.
D.	2410-36A	Bushing (use 2)	oilite	11.00 ✚
"	R2410-36A	Bushing (use 2)		6.88 ✚
"	C2550-2	Bushing installing tool		17.50 ✚
E.	2411-40	Stud, bracket spring	bare	5.00 ✚
"	R2411-40	Stud, bracket spring	cad	3.00 ✚
"	0129	Nut, spring stud	park	1.50 ✚
"	R0129P	Nut, spring stud	park	1.44 ✚
"	R0129	Nut, spring stud	cad	1.56 ✚
"	R0129C	Nut, spring stud	chrome	1.75 ✚
G.	2412-36	Spring, foot clutch lever		14.50 ✚
GA.	R2413-41	Stud, clutch lever		14.38 ✚
I.	R2419-36	Washer, spring	zinc	3.50 ✚
"	R2419-36.10pack	10 Spring washers		25.50 ✚
"	C3059-5	Friction disc, spring and disc kit		42.50 ✚

J.	R2419-41P	Washer, lever shaft	park	10.00 ✚
K.	R2430-41	Shaft, with nut		22.50 ✚
To repair worn pedal, must be welded				
L.	0142	Nut	park	3.00 ✚
M.	R2419-36B	Lockwasher	zinc	2.75 ✚
N.	R051P	Screw	park	1.44 ✚
"	R051	Screw	cad	1.50 ✚
"	R051C	Screw	chrome	2.63 ✚
O.	R0256P	Lockwasher	park	0.25 ✚
"	R0256	Lockwasher	zinc	0.25 ✚
"	R0256C	Lockwasher	chrome	0.38 ✚
P.	0108	Nut	park	1.50 ✚
"	R0108P	Nut	park	1.13 ✚
"	R0108M	Nut	cad	1.19 ✚
"	R0108C	Nut	chrome	0.88 ✚

R.	R2422-36P	End, clutch release rod	park	n.a. ✚
"	R2422-36	End, clutch release rod	cad	n.a. ✚
"	R2422-36C	End, clutch release rod	chrome	n.a. ✚
S.	R2425-36	Pull rod, foot clutch	cad '36-'64	n.a. ✚
"	R2425-36P	Pull rod, foot clutch	park '36-'64	n.a. ✚
T.	R0105AZ	Nut, pull rod	zinc	0.50 ✚
"	R0105AP	Nut, pull rod	park	0.50 ✚
"	R0354	Lockwasher	zinc	0.20 ✚

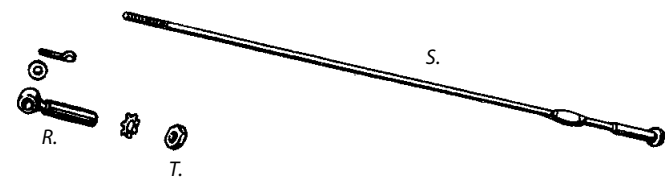

Clutch and brake pedal pads

Exact reproduction of original style pads. Bolt - on type.

R11791-45	Set of 3 pedal pads	black	17.00
R11791-45.5pack	5 Sets pedal pads	black	65.00

Clutch/brake pedal pad, slip over type, all models.

R36954-62	Pedal pad	black	3.50
R36954-62.10pack	10 Pedal pads	black	28.00



Hand Clutch Control

	C2705-5	U-bolt with nuts	park	'52-'67	17.50 ☼
	C2706-5	U-bolt with nuts	chrome	'52-'67	19.69 ☼
A.	R36918-52	Rod, hand clutch	cad	'52-'67	n.a. ☼
	R11037	Retaining ring		'52-'78	0.40 ☼
C.	C9204-3	Bolt, with nut	cad	'52-'64	11.25 ☼
"	C9203-3	Bolt, with nut	chrome	'52-'64	13.13 ☼
D.	R38498-52	Spring, booster		'52-'67	22.00
"	R38498-52C	Spring, booster	chrome	'52-'67	25.00
E.	38502-52	Eyebolt, booster spring		'52-'67	n.a. ☼
"	R38502-52	Eyebolt, booster spring		'52-'67	19.00 ☼
F.	R38505-52	Bearing		'52-'67	7.50
G.	R38618-52	Cable and coil ass.	80 cm	'52-'67	18.00
"	R38618-52.8	Cable and coil ass.	100 cm	'52-'67	19.00
	R38629-52	Inner cable only	34"		6.00
	R38630-52A	Inner cable only	61"		6.00
	38669-52	Clevis only			7.00 ☼
	38674-52	Adjusting screw only			15.00 ☼
	7744	Nut, adjusting screw			0.85 ☼
	C3063-2	Adjusting screw and nut	cad		15.00 ☼
H.	R2422-36P	End, release rod	park		n.a. ☼
"	R2422-36	End, release rod	cad		n.a. ☼
"	R2422-36C	End, release rod	chrome		n.a. ☼

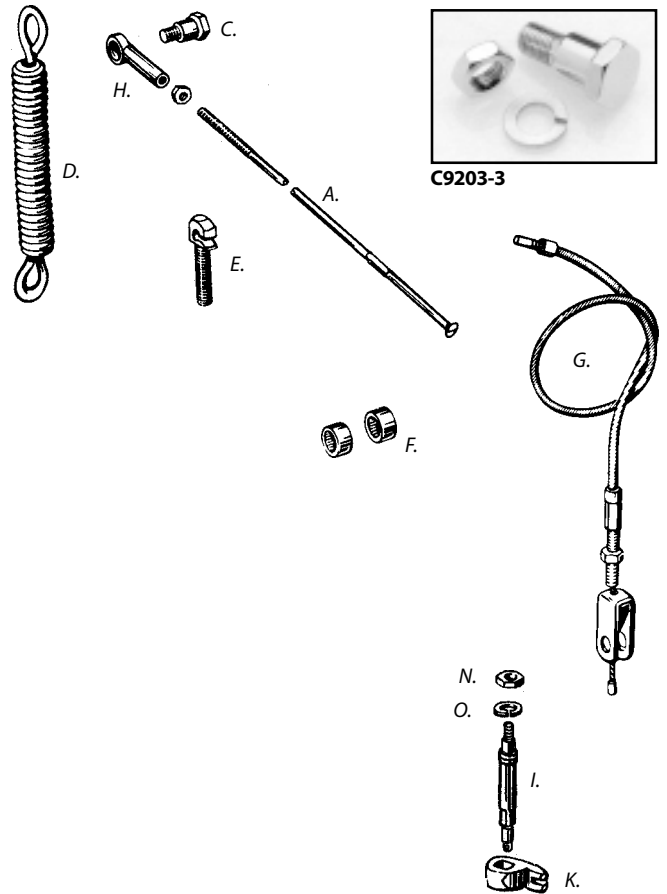

Foot and Hand Clutch Control

I.	R2430-38	Stud, release lever, cotter pin type			19.00
"	R2430-38A	Stud, release lever, snap ring type			n.a.
	R11000	Snap ring, release lever stud			0.40
	2345-38A	Bushing, release lever stud, lower			18.00 ☼
	2346-36	Bushing, release lever stud, upper			19.50 ☼
K.	R2436-39	Finger, clutch release			n.a.
L.	R2446-38	Pushrod		'38-'64	20.00 ☼
"	37285-41	Pushrod for '75-up style bearing		'38-'64	43.00 ☼
"	R37285-65	Pushrod		'65-'69	15.00 ☼
"	37285-65A	Pushrod for '75-up style bearing		'65-'69	43.00 ☼
	R37312-75	Bearing, '75-up type			6.50
	R37312-kit	Bearing kit, '75-up type			13.00
	R37228-75	Oil slinger for '75-up style bearing			6.50
M.	R2448-39	Bearing		'39-'74	28.00
N.	R0133P	Nut, release lever stud	park		1.63 ☼
"	R0133	Nut, release lever stud	cad		1.69 ☼
"	R0133C	Nut, release lever stud	chrome		1.88 ☼
O.	R0265P	Lockwasher	park		0.69 ☼
"	R0265	Lockwasher	zinc		0.75 ☼
"	R0265C	Lockwasher	chrome		0.94 ☼
	R2427-59C	Cover, clutch arm (accessory)	chrome		13.00

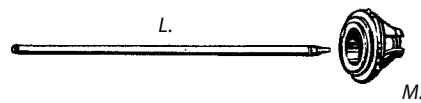

Clutch

	37550-41B	Hub, clutch complete	345.00 ☼
A.	R2472-41i	Hub, clutch (without bearing)	50.00
B.	R2470-15	Key, clutch hub	1.50
	R2470-15.10pack	10 Clutch hub keys	10.00
D.	R2472-41B	Ball, hub bearing '41-'57	0.20
E.	R2473-41	Retainer & roller kit '58-up, fits '41-up	17.50 ☼
	37566-58	Retainer only	55.00 ☼
F.	R9540A	Set rollers 0.2185"	6.00 ☼
	R9541A	Set rollers, oversize +.0001"	n.a. ☼
	R9542A	Set rollers, oversize +.0010"	6.00 ☼
G.	R2474-44	Spring, bearing plate	0.50 ☼
	R2474-44.10pack	10 Springs	4.00 ☼
H.	R2475-41	Plate, hub bearing	7.00 ☼
	R2475-41.10pack	10 Bearing plates	42.00 ☼
I.	R2477-41	Stud, inner drive hub	7.00 ☼
J.	R2478-41	Pin, inner drive hub	3.75 ☼
K.	2275-41	Nut, clutch hub early style	24.00 ☼
	R2275-41E	Nut, clutch hub early style	9.00
	37496-65	Nut, clutch hub late style	24.00 ☼
	R2275-41L	Nut, clutch hub late style	8.00
Late style nut must be used with R12014 oil seal.			
L.	R2471-41	Lockwasher, hub nut	1.40
	R2471-41.10pack	10 Hub nut lockwashers	9.00
M.	R2459-41	Spring, push rod seal	3.44 ☼
N.	R2461-36	Oil seal, push rod	2.50 ☼
	R2460-41	Retaining ring early type	1.50 ☼
	37498-41A	Retaining ring late type	3.50 ☼
	0227	Washer	1.70 ☼
O.	R12014	Oil seal, clutch hub nut (replaces cork seal and spring)	2.00
P.	R2479-41	Clutch releasing disc	20.00
ZA.	R2481-41	Disc, clutch friction	13.00
ZB.	R2481-41B	Disc, sprung	n.a.
R.	2482-41	Lining only, friction disc	7.00 ☼
S.	R2483-41	Lining, hub, with rivets	9.00
T.	2484-41	Set linings + rivets	45.00 ☼
	R2484-41	Set linings + rivets	44.00 ☼
	R2485-12	Rivet, clutch disc lining	0.35 ☼
	R2485-41	Rivet, hub lining	0.20 ☼
	2485-41A	Rivet, sprung disc lining	0.20 ☼
U.	R2487-41	Steel disc, with buffers	14.00
	37975-81T	Steel disc, without buffers	11.50
V.	R2488-41	Buffer set, steel disc (3)	7.00
W.	2505-47	Plate, clutch pressure	16.00 ☼
	R2505-47	Plate, clutch pressure	7.00
	R38010-41A	Plate, for 5-stud hubs	8.00
X.	37581-47	Nut, hub stud	2.50 ☼
	37581-47.10pack	10 Nuts, hub stud	22.00 ☼
	R2476-47	Nut, hub stud	2.00 ☼
	R2511-41	Spring, clutch	1.50
Z.	R2511-41A	Set of springs (10)	10.00
AA.	2463-41	Screw, adjusting	8.00 ☼
	R2463-41	Screw, adjusting	3.70 ☼
AB.	2465-41	Nut, adjusting screw	4.00 ☼
	R2465-41	Nut, adjusting screw	2.50 ☼

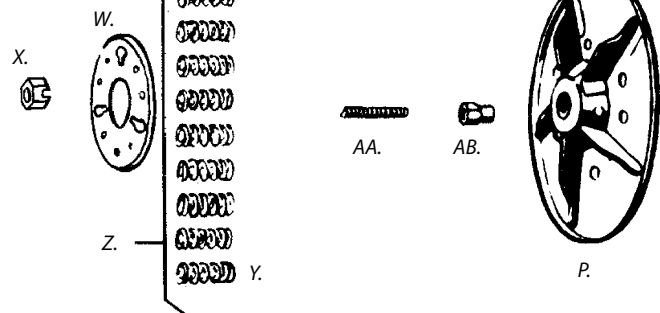
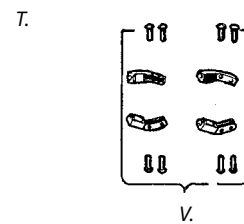
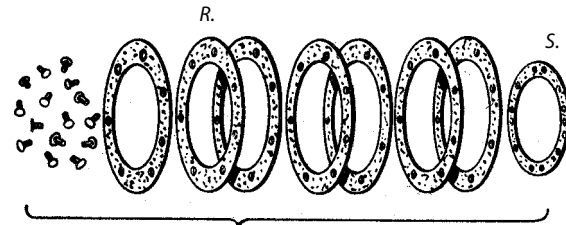
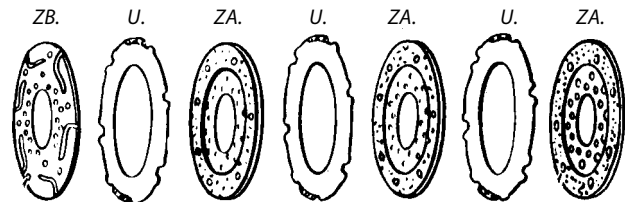
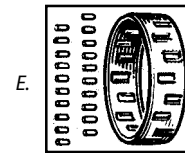
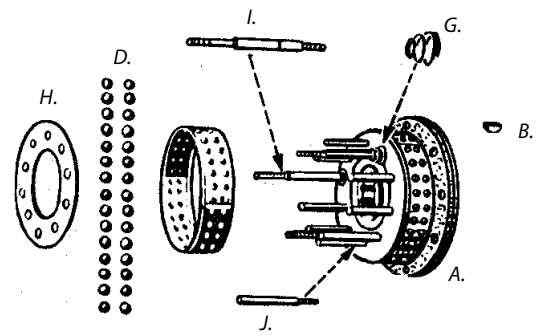

Clutch Tools

R1004A Clutch hub puller 135.00 ☼

Also removes:

- 3, 5 and 10 stud clutch hubs
- 750cc model clutch hub
- Big Twin alternator cover
- Sportster transmission sprocket
- Big Twin motor sprocket
- Sportster clutch early and late
- and many more



R1004A



R95960-52C

R95960-52C Clutch hub puller '41-'90 132.50 ☼

Use to remove Big Twin dry and wet clutch, 4 bolts included.

R2245 Clutch lock plate '41-'84 122.50 ☼

Use to lock clutch shell to clutch hub, for removing or installing clutch hub nut. Use with tool **R2316** to lock primary.



R2245



R2316



R2316 Primary locking bar 42.50 ☼

(fits between sprockets)



R2234

R2234 Locking tool black delrin 75.00 ☼

Fits between motor sprocket and primary chain.

Sprocket Nut Wrenches



R94557-55A



R94557-55A Compensating sprocket wrench '55-'70 118.50 ☼

(1/2" universal drive)



R94660-37A

R94660-37A Mainshaft sprocket nut wrench 250.00 ☼

Heavy-duty thick wall tube, inner collar will retain wrench to nut for safer service work. Has 1/2" drive end for use with universal drivers.

Chains & Sprockets

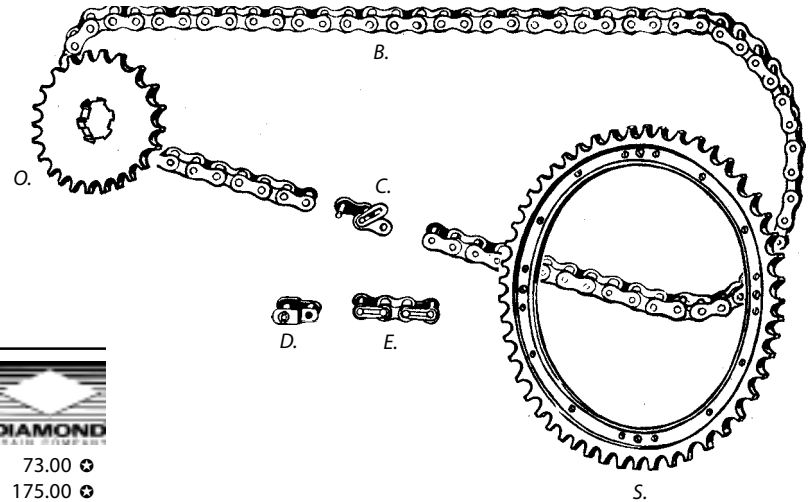
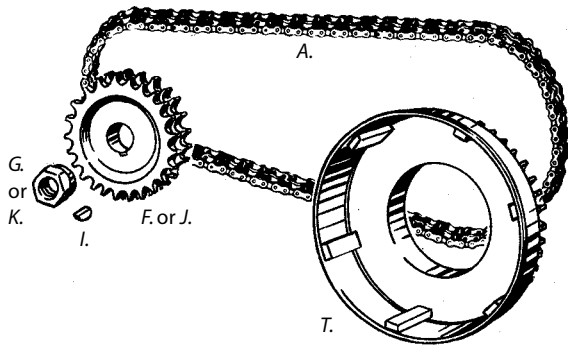

Chains

made in U.S.A. by Diamond



A.	R2001-36A	Front chain, double row	82 links	73.00 ☼
"	R2001-36A.3pack	3 Front chains	82 links	175.00 ☼
"	R2001-36AD	Front chain, shorter	80 links	70.00 ☼
"	R2001-36AN	Front chain, longer	84 links	75.00 ☼
(front chains are endless)				
B.	R2003-102	Rear chain	102 links	65.00 ☼
"	R2003-102.2pack	2 Rear chain	102 links	110.00 ☼
"	R2003-102.4pack	4 Rear chain	102 links	180.00 ☼
"	R2003-106	Rear chain	106 links	50.00 ☼
"	R2003-110	Rear chain	110 links	75.00 ☼
(rear chains are complete with connecting link)				
C.	2006-15	Link, connecting	"Diamond" rear	3.00 ☼
D.	2012-15	Link, offset repair	"Diamond" rear	n.a. ☼
E.	2015-15	Link, double repair	"Duckworth" rear	5.00 ☼
	2007-39	Link, connecting	"Duckworth" front	8.00 ☼
	2015-39	Link, double repair	"Duckworth" front	10.00 ☼

R12039-38	Chain tool (rear chain only)	6.00
R12039-X	Chain tool (front/rear chain)	12.00



H. or L.



R. P.

Front Chain Sprockets

F.	R2028-30	Motor sprocket	21 T	n.a.
"	R2028-30B	Motor sprocket	22 T	23.00
"	R2030-30	Motor sprocket	23 T	29.00
"	R2030-30B	Motor sprocket	24 T	23.00
"	R2031-30	Motor sprocket	25 T	23.00
G.	R2050-30	Nut, sprocket	11/16"-18	'30-'54 13.75 ☼
H.	C7107-1	Nut, acorn	chrome	'30-'54 12.50 ☼
I.	R361-12	Key, motor sprocket		2.75 ☼
J.	40206-55	Motor sprocket	19 T	'55-'84 55.00 ☼
"	R40208-55	Motor sprocket	21 T	'55-'84 23.00
"	40209-55	Motor sprocket	22 T	'55-'84 55.00 ☼
"	R40209-55	Motor sprocket	22 T	'55-'84 23.00
"	40210-55	Motor sprocket	23 T	'55-'84 40.00 ☼
"	R40210-55	Motor sprocket	23 T	'55-'84 23.00
"	40211-55	Motor sprocket	24 T	'55-'84 n.a. ☼
"	R40212-55	Motor sprocket	25 T	'55-'84 23.00
	40280-55A	Compensating sprocket	22 T sidecar	95.00 ☼
K.	24003-55	Nut, sprocket	7/8" -14	'55-'71 16.00 ☼
L.	C7816-1	Nut, acorn	chrome	'55-'71 18.75 ☼
M.	40302-55A	Spring, compens. sprocket		'55-'69 20.00 ☼
"	R40302-55A	Spring, compens. sprocket		'55-'69 18.00
	40385-55	Nut, sprocket shaft		'55-'69 n.a.
N.	60650-54	Plug, chain housing		'54-'64 4.00 ☼

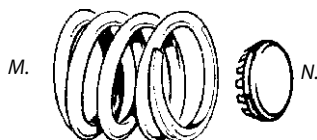

Rear Chain Sprockets

O.	R2035-36	Mainshaft sprocket	22 T	'36-'79 13.00
"	R35212-41	Mainshaft sprocket	23 T	'36-'79 15.00
"	R35213-41	Mainshaft sprocket	24 T	'36-'79 15.00
"	R35214-41	Mainshaft sprocket	25 T	'36-'79 16.00
"	R35215-41	Mainshaft sprocket	26 T	'36-'79 16.00
P.	R2335-36	Nut, mainshaft sprocket		15.63 ☼
R.	R2337-36	Lockwasher		1.50 ☼
S.	R2049-30A	Rear sprocket 51T, w. rivets		'37-'57 32.00
	R4034-30	Dust ring, brake drum		'37-'57 8.50
	R2048-30	Dowel pin		1.00 ☼
	R2048-35kit	Rivet & dowel pin kit		'37-'57 10.00 ☼
	41470-58	Rear sprocket 51T w. rivets		'58-'59 95.00 ☼
	R41470-58	Rear sprocket 51T w. rivets		'58-'59 49.00
	41470-60	Rear sprocket 51T w. rivets		'60-'61 95.00 ☼
	41470-62	Rear sprocket 51T w. rivets		'62-'66 n.a. ☼
	R41470-62	Rear sprocket 51T w. rivets		'62-'66 36.00
T.	R2039-41	Clutch sprocket	37 T	'41-'64 n.a.



Rear Brake '37-'57

A.	R4038-38A	Set brake shoes	'38-'57	31.00
B.	R4114-38	Linings set, with rivets	'38-'57	12.50
C.	R4050-30	Spring, brake shoe		3.50 ☉
D.	R4058-38	Pivot stud, with cups	'38-'57	28.75 ☉
E.	R4059-35	Pivot stud plate	zinc	5.00
F.	R0292	Cotter pin	zinc	0.15 ☉
G.	R2634-30AP	Nut	park	2.50 ☉
"	R2634-30A	Nut	cad	2.50 ☉
"	R2634-30AC	Nut	chrome	3.44 ☉
H.	R4037-37	Bushing steel	'37-'57	9.00 ☉
"	R4037-37os	Bushing .015" oversize	'37-'57	11.00 ☉
I.	R4054-37	Operating shaft	'37-'57	25.00
J.	R4055-31	Spring washer	copper	2.25 ☉
K.	R4056-36P	Lever	park	52.50 ☉
"	R4056-36C	Lever	chrome	n.a.
M.	0129	Nut	park	1.50 ☉
"	R0129P	Nut	park	1.44 ☉
"	R0129	Nut	cad	1.56 ☉
"	R0129C	Nut	chrome	1.75 ☉
N.	R4065-36	Rear brake rod	park	n.a. ☉
"	R4065-36C	Rear brake rod	chrome	16.00
O.	R4073-37	Front brake rod	park	n.a. ☉
"	R4073-37C	Front brake rod	chrome	n.a. ☉
P.	R6185-41A	Sidecar brake rod	park	32.00 ☉
R.	R4067-30	Clevis, long (11,5 cm)	park	n.a. ☉
"	R4067-30C	Clevis, long (11,5 cm)	chrome	n.a. ☉
"	Above "long" clevises are exact replacement parts			
"	R4067-51C	Clevis, short style (10cm)	chrome	10.00
S.	R2422-30A	Clevis, front	park	n.a. ☉
"	R2422-30AC	Clevis, front	chrome	6.00
T.	2423-30	Clevis pin		1.00 ☉
U.	R8045-36F	Spring washer		1.38 ☉
V.	0207	Washer		1.00 ☉
W.	R0212P	Washer	park	0.50 ☉
"	R0212C	Washer	chrome	0.45 ☉
X.	R0290P	Cotter pin	park	0.19 ☉
"	R0290	Cotter pin	zinc	0.15 ☉
XA.	R2958-35P	Lock with stud and nut	park	28.13 ☉
"	R2958-35cad	Lock with stud and nut	cad	28.13 ☉
"	R2958-35A	Brake lock stud and wing nut only		4.00 ☉
AA.	R2964-26	Spring, lever	black	6.00
"	R2964-26P	Spring, lever	park	6.00
"	R2964-26C	Spring, lever	chrome	7.50
AB.	R4075-31	Cross-over shaft		38.00
AC.	R4075-31A	Bushing		10.00 ☉
	C2712-1	Bushing installing tool		13.13 ☉
	C2796-2	Grease nipple with extension		10.94 ☉
AD.	R4076-37C	Lever, right	chrome	n.a.
AE.	R4077-36C	Lever, left	chrome	n.a.
AF.	R4078-30	Lockwasher	park	4.38 ☉
AG.	R4079-26P	Nut	park	5.94 ☉
"	R4079-26	Nut	cad	5.94 ☉
	C9677-4	Nut and washer kit	park	19.38 ☉
	C7820-4	Nut and washer kit	cad	20.00 ☉
	C8409-4	Nut and washer kit	chrome	21.88 ☉

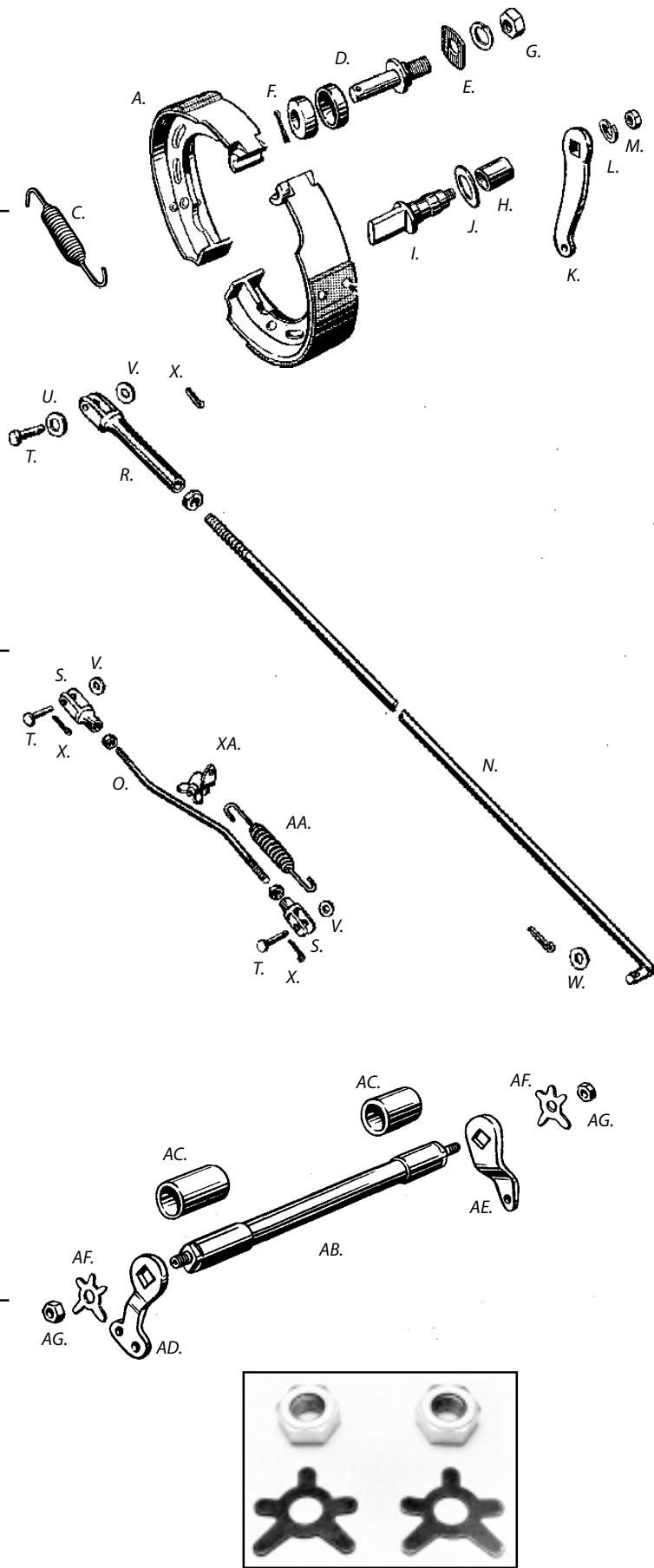

C8409-4

Rear Brake

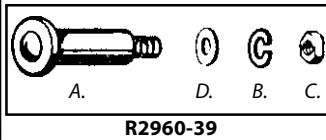

A.	R2960-36	Stud, brake lever	'39-'57	15.00	✪
"	R2960-39	Stud kit	'39-'57	31.25	✪
"	R2960-39os	Stud kit , oversize 23/32"	'39-'57	32.50	✪
B.	R0265P	Lockwasher	park '36-'71	0.69	✪
"	R0265	Lockwasher	zinc '36-'71	0.75	✪
"	R0265C	Lockwasher	chrome '36-'71	0.94	✪
C.	R0136P	Nut	park '36-'71	1.63	✪
"	R0136	Nut	cad '36-'71	1.69	✪
"	R0136C	Nut	chrome '36-'71	1.75	✪
D.	R0231P	Washer	park '36-'71	1.25	✪

Footbrake lever and bracket mounting kit '36-'71

Mounts bracket to frame and lever to bracket.

C9734-7	Mounting kit	park	6.88	✪
C9733-7	Mounting kit	cad	6.88	✪
C9732-7	Mounting kit	chrome	9.38	✪

Rear Brake '58-'65

41835-58	Hold down spring	'58-'72	n.a.	✪
E. 41836-58	Spring	upper '58-'62	17.00	✪
"	R41836-58	Spring	upper '58-'62	4.50
"	R41836-63	Spring	upper '63-'72	4.00
F. R41837-58	Spring	lower '58-'62	3.50	
"	41837-63	Spring	lower '63-'72	7.00
"	R41837-63	Spring	lower '63-'72	4.00
H. R41801-58A	Set brake shoes with linings	'58-'62	35.00	
R41808-58	Brake lining set, with rivets	'58-'62	12.00	
R41808-63	Brake lining set, with rivets	'63-'72	12.00	

J. 9995	Clamp, rear brake hose	'58-'72	4.00	✪
K. R41740-58	Cylinder, wheel brake	'58-'62	n.a.	
"	R41740-63	Cylinder, wheel brake	'63-'72	n.a.
	C3335-4	Pair of mounting screws (41742-58)	7.50	✪
L. 41743-58	Bolt, wheel cylinder	'58-'72	11.00	✪
"	R41743-58	Bolt, wheel cylinder	'58-'72	7.50
M. R41744-58	Washer, wheel cylinder bolt	'58-'72	0.75	

N. 41745-58	Swivel fitting	brass '58-'62	19.00	✪
"	R41745-58	Swivel fitting	brass '58-'62	18.00
O. R41748-58	Wheel cylinder rebuild kit	'58-'62	18.00	

P. R41748-63	Wheel cylinder rebuild kit	'63-'72	12.00	
R. 41750-63	Swivel fitting, cylinder	'63-'72	24.00	✪
"	R41750-63	Swivel fitting, cylinder	'63-'72	18.00
S. 41752-63	Swivel fitting only	'63-'72	14.00	✪
T. 41741-63	Bleeder fitting	'63-'72	6.00	✪

U. 41720-58	Anchor stud	'58-'62	35.00	✪
V. R3996-36P	Nut, anchor stud	park '58-'62	3.13	
"	R3996-36	Nut, anchor stud	cad '58-'62	3.38
"	R3996-36C	Nut, anchor stud	chrome '58-'62	5.00
41720-63	Anchor stud	'63-'72	35.00	✪
R7993	Nut, anchor stud (nylock)	'63-'72	1.25	

W. 42402-59	Lever, foot brake	zinc '59-'69	125.00	✪
X. 41835-69	Spring, brake lever	black '58-'83	11.00	✪
"	R41835-69	Spring, brake lever	black '58-'83	5.00
"	R41835-69C	Spring, brake lever	chrome '58-'83	7.00

Y. R41762-58A	Rebuild kit, master cylinder	'58-'79	14.50	
Z. R41764-58	Rubber boot only	'58-'69	4.00	
R41772-58	Piston only	'58-'68	9.00	
41773-58	Valve and seat only	'58-'68	3.00	✪
41774-58	Lockwire	'58-'68	n.a.	✪
41769-58	Spring (not in kit)	'58-'79	14.00	✪
R41769-58	Spring (not in kit)	'58-'79	2.00	
11137	O-ring, master cylinder piston		1.30	

AC. R42301-58	Brake line	rear '58-'69	n.a.	✪
"	R42301-58C	Brake line	rear chrome '58-'69	n.a.
AD. R42302-58	Brake line	front '58-'69	n.a.	✪
"	R42302-58C	Brake line	front chrome '58-'69	n.a.

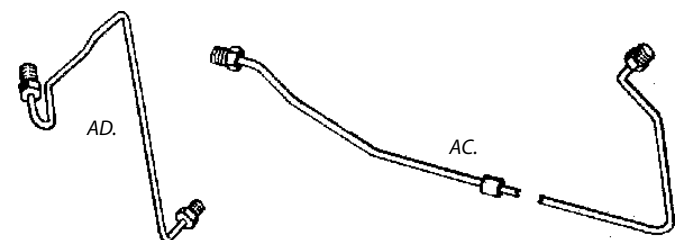
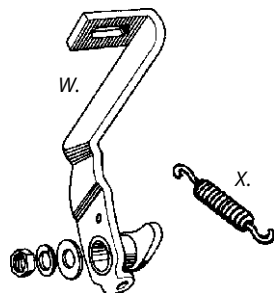
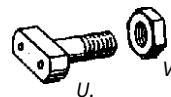
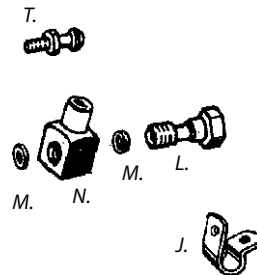
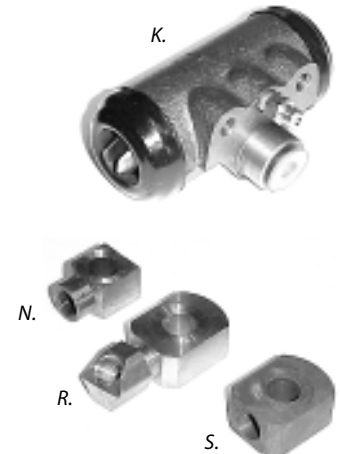
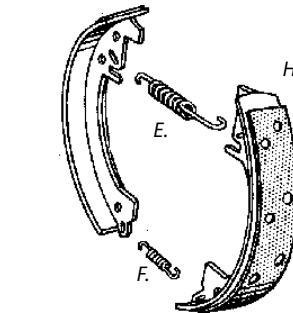

Spoke Sets

3943-36N	Spoke	18" wheel	park	n.a.
R3947-29P	Nipple		park	n.a.
R3947-29	Nipple		cad	1.60
R3947-29C	Nipple		chrome	1.80
R3943-40Achr	Set spokes and nipples	16" chrome		47.00
3942-40A	Set spokes and nipples	18" park		n.a.

(the 18" wheel sets are original new spokes with repro nipples)



C2693-1	Spoke nipple wrench	65.63	⊕
C2662-1	Spoke nipple wrench, metric	61.25	⊕

Wheel Hub

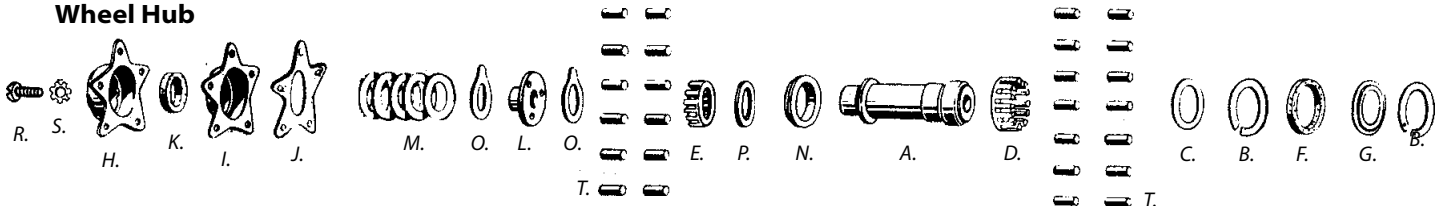

A.	R3963-35i	Bearing sleeve		18.00
"	R3963-35i.10pack	10 Bearing sleeves		130.00
B.	R3965-35	Ring, lock retaining		1.70
C.	3966-39	Washer, brake thrust		3.50 ⊕
"	R3966-39	Washer, brake thrust		2.25
D.	3967-35	Retainer, roller	large	18.00 ⊕
"	R3967-35	Retainer, roller	large	14.00
E.	417-30	Retainer, roller	small	n.a.
F.	3968-35	Washer, sprocket side	(cork)	1.50 ⊕
"	R3968-35	Washer, sprocket side	(cork)	3.00 ⊕
G.	3970-35	Retainer, cork washer		2.50 ⊕
H.	3972-35	Cover, outer	park '36-'54	19.00 ⊕
I.	3974-35	Cover, inner	'36-'54	n.a.
	43574-55	Cover, inner	'55-'66	n.a.
J.	R3975-35	Gasket, inner cover		1.70 ⊕
K.	3976-35	Washer, small	(cork)	1.50 ⊕
"	R3976-35	Washer, small	(cork)	3.00 ⊕
L.	R3978-35	Sleeve, thrust bearing		20.00
M.	R3980-35.002	Shim, thrust adjusting	.002"	0.40 ⊕
"	R3980-35.002.10pack	10 Shims	.002"	3.00 ⊕
"	R3980-35.007	Shim, thrust adjusting	.007"	0.50 ⊕
"	R3980-35.007.10pack	10 Shims	.007"	4.00 ⊕
N.	3981-39	Thrust collar (pressed in hub)		n.a. ⊕
O.	3982-35	Washer, thick thrust		8.00 ⊕
"	R3982-35	Washer, thick thrust		3.50
"	R3982-35.10pack	10 Washers, thick thrust		28.00 ⊕
P.	R3982-39	Washer, hub sleeve thrust		2.50

Cover Screws

R.	050	Screw, outer cover	park	2.00 ⊕
"	R050P	Screw, outer cover	park	1.38 ⊕
"	R050	Screw, outer cover	cad	1.44 ⊕
"	R050C	Screw, outer cover	chrome	1.63 ⊕
S.	R0363P	Lockwasher	park	0.38 ⊕
"	R0363	Lockwasher	zinc	0.20 ⊕

Kits include 5 screws with lockwashers.

C9670-10	Kit	slotted heads	park	8.13 ⊕
C8201-10	Kit	slotted heads	cad	8.13 ⊕
C8200-10	Kit	slotted heads	chrome	11.25 ⊕
C7144-5	Kit	acorn heads	chrome	18.75 ⊕
C8451-5	Kit	cap heads	chrome	18.75 ⊕

Bearing Rollers

Rollers are sold each or in 100-packs.

T.	R2289-25	Roller, standard	0.2498" x .490"	0.50 ⊕
"	R9219	Roller, oversize	+ .0001"	0.50 ⊕
"	R2289-25D	Roller, oversize	+ .0002"	0.50 ⊕
"	R9218	Roller, oversize	+ .0003"	0.50 ⊕
"	R2289-25F	Roller, oversize	+ .0004"	0.50 ⊕
"	R9217	Roller, oversize	+ .0005"	0.50 ⊕
"	R2289-25H	Roller, oversize	+ .0006"	0.50 ⊕
"	R2289-25KA	Roller, oversize	+ .0008"	0.50 ⊕
"	R2289-25MA	Roller, oversize	+ .0010"	0.50 ⊕
"	R2289-25MA2	Roller, oversize	+ .0020"	0.50 ⊕

Wheel Bolts

U.	R4026-35	Wheel bolt	3/8" -20	park	3.00 ⊕
"	R4026-35P	Wheel bolt Colony	3/8" -20	park	6.00 ⊕
"	R4026-35C	Wheel bolt	3/8" -20	chrome	2.20 ⊕
"	R4026-35S	Oversize bolt Colony	7/16" -20	park	6.00 ⊕
V.	4035-37	Dowel pin, brake drum			4.00 ⊕

R11815-35 Wrench, wheel mounting bolt 11.00

Special design has longer short end for easier use on 16" wheels.

11817-40	Extension, wrench	7.00 ⊕
R12025-35	Shop wrench, wheel bolts	75.00 ⊕

tap160-807	Tap	3/8"-20	Standard screws	10.00
M1440T	Tap	7/16"-20	Oversize screws	n.a. ⊕

Heli-Coil® thread repair

H5540-6	Thread repair kit	3/8"-20	(includes tap, installation tool and 6 inserts)	83.00 ⊕
HR389-6	Set Heli-Coil® inserts only	(6)		16.00 ⊕
M6125D	Drill, use with kit	25/64"		n.a. ⊕

Tools

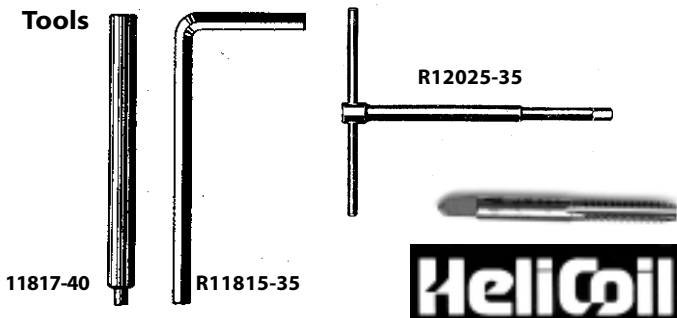

R12025-35

11817-40

R11815-35



Axles

Rear Axle

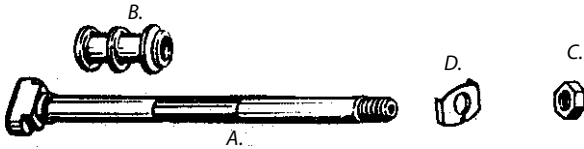

A.	R3995-36C	Rear axle	'36-'57	chrome	42.00
"	R41552-58AC	Rear axle	'58-'66	chrome	35.00
B.	R4007-36P	Spacer, axle	'36-'57	park	22.50 ☼
"	R4007-36	Spacer, axle	'36-'57	zinc	17.00 ☼
"	R4007-36C	Spacer, axle	'36-'57	chrome	28.75 ☼
"	41595-58	Spacer, axle	'58-'66	park	65.00 ☼
"	C2872-1	Spacer, axle	'58-'66	park	20.63 ☼
"	R41595-58	Spacer, axle	'58-'66	zinc	17.00 ☼
"	R41595-58C	Spacer, axle	'58-'66	chrome	22.00 ☼
"	R41596-58	Spacer, plate	'58-'62	zinc	8.50
"	R41596-58C	Spacer, plate	'58-'62	chrome	9.00 ☼
C.	R3996-36P	Nut, axle	'36-'72	park	3.13 ☼
"	R3996-36	Nut, axle	'36-'72	cad	3.38 ☼
"	R3996-36C	Nut, axle	'36-'72	chrome	5.00 ☼
D.	R3958-32P	Lockwasher	'36-'72	park	6.88 ☼
"	R3958-32	Lockwasher	'36-'72	cad	6.88 ☼
"	R3958-32C	Lockwasher	'36-'72	chrome	7.50 ☼

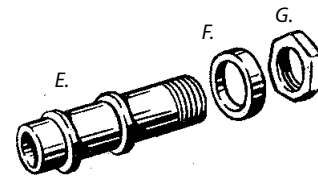

E.	R4008-36	Axle sleeve	'36-'57		31.00 ☼
"	R41600-58	Axle sleeve	'58-'62		32.00 ☼
"	R41600-63	Axle sleeve	'63-'66		32.00 ☼
F.	R3961-30P	Collar, sleeve	'36-'72	park	6.25 ☼
"	R3961-30	Collar, sleeve	'36-'72	cad	6.25 ☼
"	R3961-30C	Collar, sleeve	'36-'72	chrome	8.75 ☼
G.	R3963-30P	Nut, axle sleeve	'36-'72	park	13.75 ☼
"	R3963-30	Nut, axle sleeve	'36-'72	cad	13.75 ☼
"	R3963-30C	Nut, axle sleeve	'36-'72	chrome	15.63 ☼

Axle Nut Kits

Include axle nut, sleeve nut, spacer, lockwasher

C9692-4	Axle nut kit	'36-'72	park	30.00 ☼
C8161-4	Axle nut kit	'36-'72	cad	30.00 ☼
C8160-4	Axle nut kit	'36-'72	chrome	37.50 ☼
C7013-3	Axle nut and cover kit	'36-'72	acorn	31.25 ☼

(includes one nut and one axle cover, instructions included)



C8160-4



C7013-3

Axle Adjusters (rear chain adjusters)

R2827-36P	Adjusting screw		park	7.19 ☼
R2827-36	Adjusting screw		cad	7.19 ☼
R2827-36C	Adjusting screw		chrome	8.44 ☼
R2827-36T	Adjusting screw		chrome	4.00
R2826-30	Extra long adjusting screw		cad	12.50 ☼
R3011-30	Spacer for long adjusting screw		park	3.75 ☼

(long screw with spacer can be used for easier access on sidecar models)



R2827-36P

Heli-Coil® thread repair

To repair 3/8"-24 thread in frame for axle adjusters.

Kit includes tap, 12 inserts and installation tool

H5528-6	Heli-coil repair kit			65.00 ☼
HR1191-6	Set inserts only			26.00 ☼
M6125D	Drill, use with kit	25/64"		n.a. ☼



Front Axle

H.	43875-48	Front axle	'49-'66	zinc	n.a. ☼
I.	R43882-48	Axle sleeve	'49-'66		32.50 ☼
J.	R4178-42P	Axle nut	'42-'72	park	6.25 ☼
"	R4178-42	Axle nut	'42-'72	cad	7.50 ☼
"	R4178-42C	Axle nut	'42-'72	chrome	9.38 ☼
K.	R13458-36P	Washer	'42-'66	park	1.25 ☼
"	R13458-36cad	Washer	'42-'66	cad	1.38 ☼
"	R13458-36C	Washer	'42-'66	chrome	1.75 ☼
L.	R0292P	Cotter pin		park	0.25 ☼
"	R0292	Cotter pin		zinc	0.15 ☼
M.	R4184-30P	Nut, sleeve	'36-'71	park	7.50 ☼
"	R4184-30	Nut, sleeve	'36-'71	cad	8.13 ☼
"	R4184-30C	Nut, sleeve	'36-'71	chrome	10.00 ☼

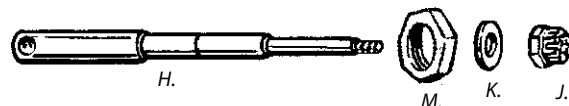

Front Axle Nut Kits

Include axle nut, sleeve nut and washer.



C8163-3

C2816-3	Axle nut kit	'42-'71	park	15.63 ☼
C8163-3	Axle nut kit	'42-'71	cad	16.25 ☼
C8162-3	Axle nut kit	'42-'71	chrome	21.25 ☼

	C2082-5	Pivot stud kit		'49-'71	32.19 ☉
B.	44448-48	Pivot stud		'49-'71	32.00 ☉
"	R44448-48	Pivot stud		'49-'71	28.75 ☉
C.	44454-48	Washer, pivot stud		'49-'71	7.00 ☉
"	R44454-48	Washer, pivot stud		'49-'71	1.88 ☉
D.	R0265P	Lockwasher	park	'36-'71	0.69 ☉
"	R0265	Lockwasher	zinc	'36-'71	0.75 ☉
"	R0265C	Lockwasher	chrome	'36-'71	0.94 ☉
E.	R0133P	Nut	park	'36-'71	1.63 ☉
"	R0133	Nut	cad	'36-'71	1.69 ☉
"	R0133C	Nut	chrome	'36-'71	1.88 ☉
F.	2964-35	Spring, brake shoe	black	'49-'56	n.a.
"	R41835-69	Spring, brake shoe (heavy)		'49-'71	5.00
	45175-49	Clevis, brake cable		'49-'68	n.a. ☉
	45180-49	Bolt only (from clevis)			3.50 ☉
	C3291-2	Clamp and nut, clevis	cad		11.25 ☉
	R7725	Flexlock nut, clevis clamp			1.88 ☉
	44525-49	Clevis pin			7.80 ☉

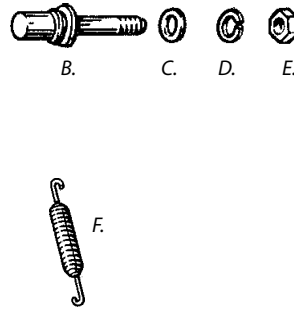

C2082-5

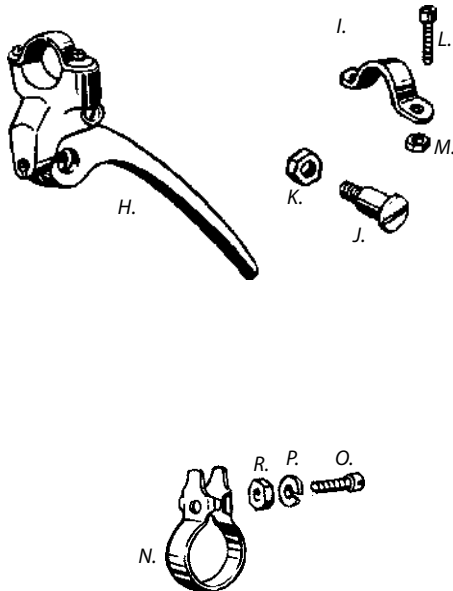

H.	R4149-41	Hand brake lever	alu	'41-'64	34.50
"	R4149-41C	Hand brake lever	chrome	'41-'64	39.50
"		Lever only	alu	'41-'64	6.00
I.	R4153-28	Clamp	cad	'41-'64	11.25 ☉
"	R4153-28P	Clamp	park	'41-'64	11.25 ☉
J.	4156-41	Screw, pivot		'41-'64	3.00 ☉
K.	0108	Nut, pivot screw	park		1.50 ☉
"	R0108P	Nut, pivot screw	park		1.13 ☉
"	R0108M	Nut, pivot screw	cad		1.19 ☉
"	R0108C	Nut, pivot screw	chrome		0.88 ☉
L.	R033LP	Screw, bracket	3/4" park	'41-'64	0.75 ☉
"	R033L	Screw, bracket	3/4" cad	'41-'64	0.75 ☉
"	R033LC	Screw, bracket	3/4" chrome	'41-'64	0.90 ☉
"	R033XL	Screw, bracket	1" cad	'41-'64	0.75 ☉
"	R033XLC	Screw, bracket	1" chrome	'41-'64	0.90 ☉
"	C8797-4	Set of 4 Allen head screws			6.75 ☉
"	C8797-4-P	Set of 4 polished Allen head screws			7.25 ☉
M.	R0104P	Nut, bracket screw	park		0.50 ☉
"	R0104Z	Nut, bracket screw	zinc		0.40 ☉
"	R0104C	Nut, bracket screw	chrome		0.75 ☉
N.	4160-28	Clamp, cable	'36-'60 black		19.00 ☉
"	R4160-28	Clamp, w. screw and nut	park		13.75 ☉
O.	053	Screw, cable clamp	park		3.00 ☉
"	R053C	Screw, cable clamp	chrome		1.80 ☉
P.	R0256P	Lockwasher	park		0.25 ☉
"	R0256	Lockwasher	zinc		0.25 ☉
"	R0256C	Lockwasher	chrome		0.38 ☉
R.	0108	Nut, cable clamp screw	park		1.50 ☉
"	R0108P	Nut, cable clamp screw	park		1.13 ☉
"	R0108M	Nut, cable clamp screw	cad		1.19 ☉
"	R0108C	Nut, cable clamp screw	chrome		0.88 ☉

S.	R45137-51	Wire, control	120 cm	'49-'71	n.a.
"	R45137-51L	Wire, control	extra long	'49-'71	4.00
T.	R45109-49	Ferrule, control coil		park	4.00 ☉
U.	C2883-3	Adjusting screw		cad '49	25.63 ☉
"	C8818-3	Adjusting screw		cad '50-'71	19.38 ☉
"	C9741-2	Adjusting screw		chrome '50-'71	20.00 ☉
V.	R45202-50	Cable tube, straight		cad '49-'71	n.a. ☉
"	R45202-50C	Cable tube, straight		chrome '49-'71	n.a. ☉
W.	R45200-60	Cable tube, curved		cad '60-'67	n.a. ☉
				(footshift only)	
"	R45200-60C	Cable tube, curved		chrome '60-'67	n.a. ☉
				(footshift only)	
X.	R9963	Clip, cable tube		cad '50-'71	11.00 ☉
	C3304-2	Cable tube fitting and seat		'49-'71	9.38 ☉

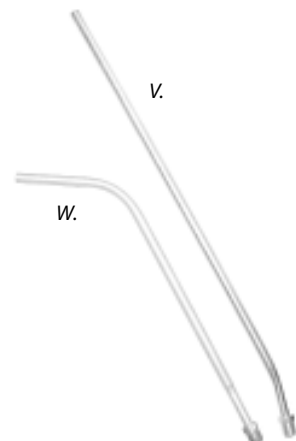
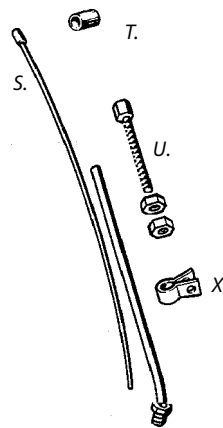

Front Fork

R45700-48C	Fork stem and bracket	chrome	175.00
C9803-4	Triple tree bolts	stock chrome	9.19 ✖
C9782-4	Triple tree bolts	Allen chrome	8.75 ✖
C9782-4-P	Triple tree bolts polished	Allen chrome	9.50 ✖
Fork Stem Nuts (models without steering damper)			
45717-63	Lockwasher, stem nut	'60-early '77	12.00 ✖
R45717-63	Lockwasher, stem nut	'60-early '77	3.13 ✖
45718-60	Nut, fork stem park	'60-early '77	18.50 ✖
R45718-60	Nut, fork stem park	'60-early '77	15.00 ✖
C8808-2	Stem nut w. lockwasher	'60-early '77	17.50 ✖
C2184-2	Stem nut w. lockwasher	chrome	19.38 ✖
C7009-1	Acorn stem nut 1"-24	'60-early '77	18.75 ✖

Adjustable Fork Parts

45710-58	Washer, bracket bolt	'58-early '77	17.00 ✖
45711-51A	Bolt, fork bracket	'50-early '77	47.00 ✖
7947W	Nut, bracket bolt	'58-early '77	5.00 ✖
C3303-5	Bolt and washer kit	'58-early '77	80.00 ✖



C2185-4 Upper bracket bolt and lock kit (OEM 45752-50 and 45753-50) 20.94 ✖

C8872-1	Fork tube bolt, flat type	zinc	'49-'77	18.75 ✖
C9911-1	Fork tube bolt, flat type	chrome	'49-'77	24.69 ✖
C7620-1	Fork tube bolt, domed	chrome	'49-'77	26.25 ✖
C8226-1	Fork tube plug	chrome	'49-'77	28.75 ✖
C2317-1	Wrench for flat bolt			48.44 ✖
C2319-1	Wrench for domed bolt			51.56 ✖



R45733-48	Oil seal, tube plug		1.25 ✖
45765-49	Stud, fork baffle		17.00 ✖
45775-49	Plug, slider tube		125.00 ✖
45775-50	Plug, slider tube (adjustable fork)		150.00 ✖
A. 45823-49	Bushing, lower		39.00 ✖
" R45823-49	Bushing, lower		15.00 ✖
B. 45824-49	Bushing, upper		43.00 ✖
" R45824-49	Bushing, upper		15.00 ✖
C. 45826-49	Shim, slider bushing		2.00 ✖
D. R45849-49	Fork seal kit		14.50
45850-48	Felt washer, upper oil seal		5.00 ✖
45852-48	Oil seal, upper		8.00 ✖
E. 45854-48	Retaining washer		4.00 ✖
" R45854-48	Retaining washer		1.30
F. R45856-48	Retaining ring, tube top		1.50 ✖
G. 45972-48	Bushing, fork tube taper		27.00 ✖
H. 46051-49A	Set of fork springs		95.00 ✖
" R46051-49A	Set of fork springs		49.00 ✖
46111-48	Gasket, damper tube stud		1.00 ✖
R46111-48	Gasket, damper tube stud		0.60 ✖
46121-48	Lower bushing, damper tube		22.00 ✖
R46121-48	Lower bushing, damper tube		6.00 ✖
46125-48	Gasket, damper tube bushing		3.00 ✖
R46125-48	Gasket, damper tube bushing		0.80 ✖
46128-48	Washer, damper tube end		17.50 ✖
I. 46172-48	Retaining ring, lower		3.00 ✖
" R46172-48	Retaining ring, lower		0.70 ✖
C9909-2	Slider drain screws (pair)		4.38 ✖
45830-48	Drain plug, fork tube		7.00 ✖
R45830-48	Drain plug, fork tube		n.a. ✖
C8813-4	Fork bottom stud kit		12.50 ✖
45840-48	Stud, slider bottom		13.50 ✖
R45836-48	Bottom cap, right slider		18.00

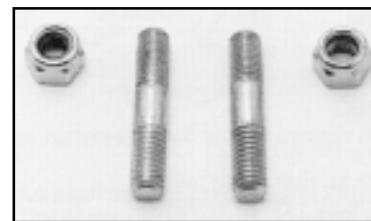
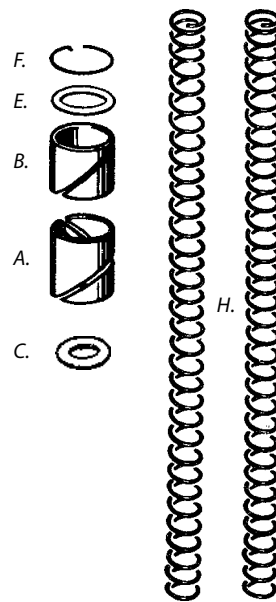

C8813-4



C9909-2

46710-48	Cover, spider spring	black	'49-'59	n.a. ✖
46715-48	Spider spring		'49-'84	29.00 ✖
46718-48	Pressure disc		'49-'84	n.a. ✖
46720-48	Pressure disc, lower		'49-'84	22.00 ✖
46730-48	Anchor plate		'49-'84	35.00 ✖
L. 46743-60	Adjusting screw, damper		'60-'84	22.00 ✖
M. R46751-48	Spring, adjusting screw		'49-'84	1.50

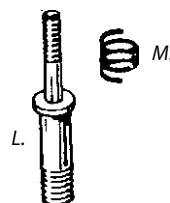

R48300-49	Head bearing		'49-'59	16.00
N. R48300-60	Head bearing		'60-up	12.50
O. R48311-60	Cups with inner race (set)		'60-'84	42.00
P. 48365-48A	Dust shield, lower			7.00 ✖
S. R48365-48A	Dust shield, lower			2.00

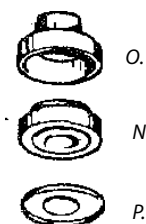

Fork Tools

R1725 Steering head bearing race installer 100.00 ☺
Use to install bearing races in cups as well as cups in frame.

R2232 Steering head bearing race driver 125.00 ☺
Use to remove and install steering head bearing race.
For best results use with spacer **R2388**.

R2388 Spacer, bearing race removal tools 64.50 ☺
The effectiveness of any bearing race remover tool is dependent on the ability to grip the race. This spacer applies outward force on the bearing race tool, to grip the race better, allowing easier removal of the race.



R1725



R2232



R2388

R2244 Top fork nut socket 35mm, 3/8" drive 116.50 ☺
Use to remove or install top fork nut on all glide forks.
Has rubber protector on inside to prevent damage to nut.

R2043 Fork tube plug socket 90.00 ☺
Use to remove and install top fork tube plug, eliminates possible burring of plug caused by wrenches.

Fork seal and cap installers. Use to install fork seals, dust seals and chrome caps. Lightly grease to keep from scratching fork tubes.

- R2044** 39mm Slider with delrin cap 200.00 ☺
- R2045** 35mm Slider only 107.50 ☺
- R2046** 39mm Slider only 110.00 ☺
- R2047** 41mm Slider only 110.00 ☺
- R2048** Delrin cap only 110.00 ☺



R2244

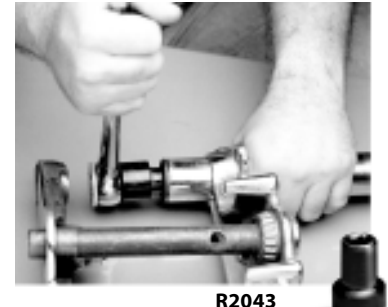

R2043

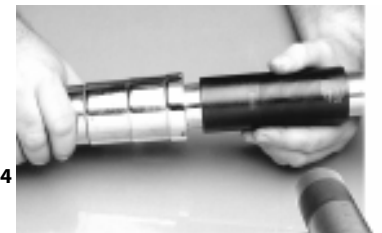

R2044

Rear Fork Parts

- A. **47510-58** Bolt, pivot 75.00 ☺
- B. **47513-58** Lockwasher, pivot bolt 6.00
- " **R47513-58** Lockwasher, pivot bolt 1.30
- C. **47517-58** Spacer, pivot bearing 19.00 ☺
- " **R47517-58** Spacer, pivot bearing 10.50 ☺
- D. **R47519-83** Seal, pivot bearing 3.00 ☺
- " **R47519-83A.2pack** Seal, pivot bearing 7.00 ☺
- E. **R9033** Bearing 14.50
- F. **R3996-36P** Nut, pivot bolt park 3.13 ☺
- " **R3996-36** Nut, pivot bolt cad 3.38 ☺
- " **R3996-36C** Nut, pivot bolt chrome 5.00 ☺

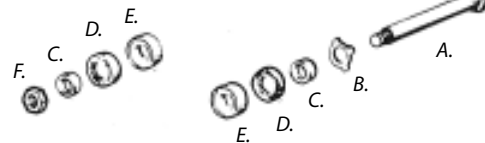

Safety Guard Mounting '36-'57

- C9532-13** Rear guard mounting kit park 43.75 ☺
- C9531-13** Rear guard mounting kit cad 43.75 ☺
- C9530-13** Rear guard mounting kit chrome 51.25 ☺
- C2477-10** Front guard mt kit park '48-'50 18.75 ☺
- C2631-8** Front guard mt kit cad '51-'54 6.88 ☺
- C2630-8** Front guard mt kit chrome '51-'54 7.50 ☺



C9532-13

Safety Guard Mounting '58-'69

- C2187-11** Front guard mounting hardware cad 9.38 ☺
- C2186-11** Front guard mounting hardware chrome 10.00 ☺

Rear Stand Parts

- L. **C8015-4park** Mounting kit park '38-'57 23.75 ☺
- " **C8015-4cad** Mounting kit cad '38-'57 24.38 ☺
- " **C9616-4** Mounting kit chrome '38-'57 27.50 ☺
- M. **R3060-38P** Shoulder bolt park '38-'57 10.00 ☺
- " **R3060-38B** Shoulder bolt black '38-'57 4.00
- " **R3060-38** Shoulder bolt cad '38-'57 10.00 ☺
- " **R3060-38C** Shoulder bolt chrome '38-'57 11.25 ☺
- N. **R3063-38P** Washer, bolt park '38-'57 1.63 ☺
- " **R3063-38** Washer, bolt cad '38-'57 1.63 ☺
- " **R3063-38C** Washer, bolt chrome '38-'57 1.88 ☺



- O. **0129** Nut park 1.50 ☺
- " **R0129P** Nut park 1.44 ☺
- " **R0129** Nut cad 1.56 ☺
- " **R0129C** Nut chrome 1.75 ☺
- P. **R0261P** Lockwasher park 0.25 ☺
- " **R0261** Lockwasher zinc 0.25 ☺
- " **R0261C** Lockwasher chrome 0.38 ☺
- L. **R0129** Nut park 1.50 ☺
- " **R0129P** Nut park 1.44 ☺
- " **R0129** Nut cad 1.56 ☺
- " **R0129C** Nut chrome 1.75 ☺
- P. **R0261P** Lockwasher park 0.25 ☺
- " **R0261** Lockwasher zinc 0.25 ☺
- " **R0261C** Lockwasher chrome 0.38 ☺

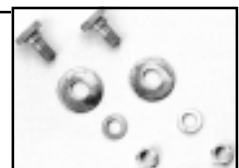

Footboards

A.	R2938-40	Set footboards (no logo)	black	n.a.
"	R2938-40C	Set footboards (no logo)	chrome	37.00
(Footboard sets include black footboard mats)				
"	R2938-40M	Set footboards, black with steel plates		n.a.
"	R2938-40MC	Set footboards, chrome/chrome plates		n.a.
C.	R2941-14	Set of footboard mat rivets (28)		6.95 ☼
"	R2941-42M	Set of footboard mat rivets (28) shorter		7.95 ☼
D.	R2940-40C	Set steel footboard plates	chrome	n.a.



Footboard Mounting Parts

	R2948-36P	Stud, left rear	'36-'54 park	22.50 ☼
	R2949-36P	Stud, right rear	'36-'54 park	22.50 ☼
	R2950-36P	Stud, front	'36-'57 park	15.00 ☼
	C2675-20	Footboard stud kit	'36-'54 park	72.19 ☼
	C3154-18	Footboard stud kit	'55-'57 park	81.25 ☼
	C2912-14	Footboard stud kit	'58-'64 park	106.00 ☼
	C3168-16	Footboard stud kit	'65-'69 park	73.75 ☼
	0129	Nut	park	1.50 ☼
	R0129P	Nut	park	1.44 ☼
	R0129	Nut	cad	1.56 ☼
	R0129C	Nut	chrome	1.75 ☼
	R0225P	Washer	park	0.63 ☼
	R0261P	Lockwasher	park	0.25 ☼
	R0261	Lockwasher	zinc	0.25 ☼
	R0261C	Lockwasher	chrome	0.38 ☼
E.	2944-40	Hinge, footboard - right front, left rear		14.00 ☼
F.	2944-40A	Hinge, footboard - left front, right rear		19.00 ☼
G.	2945-14	Rivet, repair hinge		1.00 ☼
H.	2954-42	Bolt, footboard hinge	park	5.00 ☼
"	R2954-42P	Bolt, footboard hinge	park	3.44 ☼
"	R2954-42	Bolt, footboard hinge	cad	4.06 ☼
"	R2954-42C	Bolt, footboard hinge	chrome	4.38 ☼
I.	0108	Nut	park	1.50 ☼
"	R0108P	Nut	park	1.13 ☼
"	R0108M	Nut	cad	1.19 ☼
"	R0108C	Nut	chrome	0.88 ☼
J.	R0256P	Lockwasher	park	0.25 ☼
"	R0256	Lockwasher	zinc	0.25 ☼
"	R0256C	Lockwasher	chrome	0.38 ☼

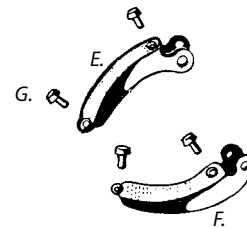

Hinge Bolt Kits

	C9685-12	Set bolts & nuts	park	15.94 ☼
	C8773-12	Set bolts & nuts	cad	16.88 ☼

(use without buddy seat footrests)

	C9722-18	Set bolts, nuts & pins	park	24.38 ☼
	C8774-18	Set bolts, nuts & pins	cad	25.00 ☼

(use with early style buddy seat footrests)



C8773-12



C8774-18

Jiffy Stand Parts

	R13200-36C	Bracket, jiffy stand	chrome	18.00
B.	13203-36	Plate, spring	park	18.00 ☉
"	R13203-36C	Plate, spring	chrome	7.50
C.	R13205-36P	Leg stop	park	9.00 ☉
"	13205-36	Leg stop	zinc	6.00 ☉
D.	4048-30	Spring, for jiffy leg	bare	20.00 ☉
E.	R0229P	Washer	park	0.63 ☉
F.	R0265P	Lockwasher	park	0.69 ☉
"	R0265	Lockwasher	cad	0.75 ☉
"	R0265C	Lockwasher	chrome	0.94 ☉
G.	R0133P	Nut	park	1.63 ☉
"	R0133	Nut	cad	1.69 ☉
"	R0133C	Nut	chrome	1.88 ☉

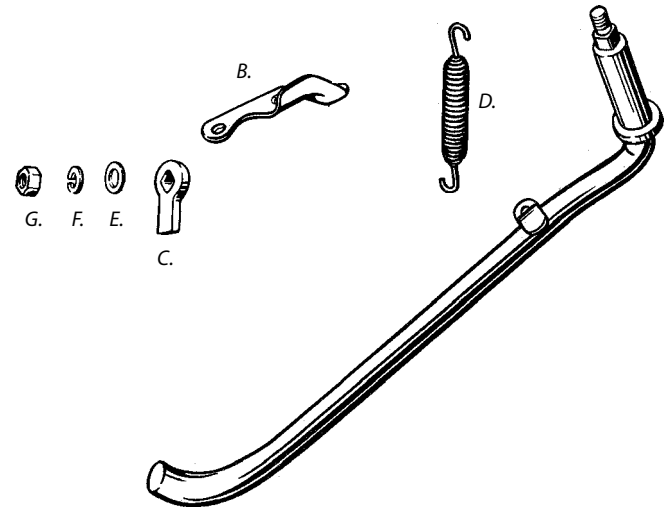

Jiffy stand mounting kit

Bolts and nuts mount clutch or shifter to frame and jiffy to bracket.

	C9619-18	Mounting kit	park	28.13 ☉
	C9618-18	Mounting kit	cad	28.13 ☉
	C9617-18	Mounting kit	chrome	33.75 ☉

Jiffy stand to clutch or shifter bracket bolts with acorn nuts

	C7803-11	Acorn mounting kit	chrome	29.38 ☉
--	-----------------	--------------------	--------	---------

C9619-18

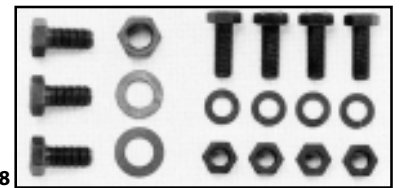

Seat Mounting

H.	R3110-37	Front bushing set '37-'64		12.50
	C9676-5	Bushing and bolt set '37-'64	park	38.75 ☉
	C8875-5	Bushing and bolt set '37-'64	cad	40.00 ☉
	C8876-5	Bushing and bolt set '65-'80	cad	40.00 ☉
I.	3111-29	Pin, seat bar	park	7.00 ☉
"	R3111-29	Pin, seat bar	park	2.00
"	R3111-29.10pack	10 Seat bar pins	park	15.00
J.	R3112-29	Spring, pin		4.75 ☉
K.	R3113-36	Bushing, seat post '36-'57		27.50 ☉
L.	47094-58	Bushing, seat post '58-'80		14.00 ☉
"	C2084-2	Bushings (2) '58-'80		28.75 ☉
	C2086-1	Tool, bushing installation '36-'57		17.81 ☉
	C2085-2	Tool, bushing installation '58-'80		56.88 ☉
M.	3117-29	Link, plunger		n.a.
N.	3118-29	Rivet, plunger link		5.00 ☉
O.	3119-13	Bushing, plunger link		6.00 ☉

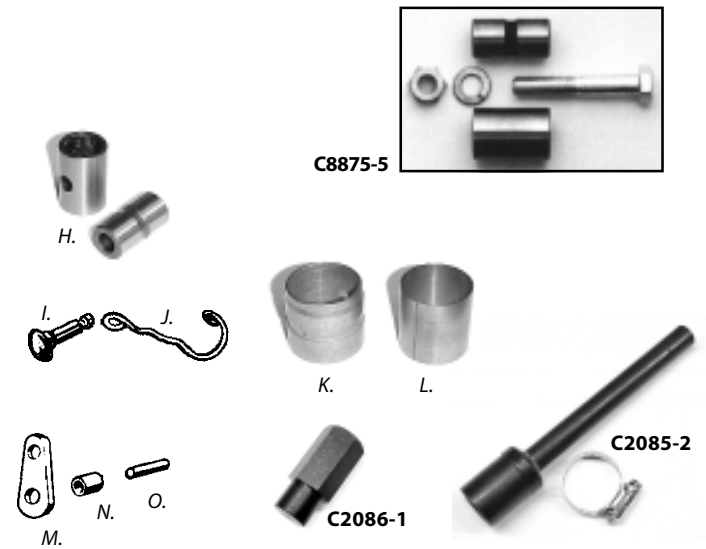

Solo Seat Mounting

P.	3187-34	Bolt, front	park	5.00 ☉
"	R3187-34	Bolt, front	cad	n.a. ☉
R.	3189-34	Washer, curved	park	4.00 ☉
"	R3189-34	Washer, curved	cad	3.13 ☉
S.	R0225P	Washer 3/8	park	0.63 ☉
T.	R0261P	Lockwasher	park	0.25 ☉
"	R0261	Lockwasher	zinc	0.25 ☉
U.	0129	Nut	park	1.50 ☉
"	R0129P	Nut	park	1.44 ☉
"	R0129	Nut	cad	1.56 ☉
V.	3205-34	Stud	park	n.a. ☉
"	R3205-34	Stud	park	4.06 ☉
W.	R3209-31P	Spacer 1/4"	park	3.13 ☉
"	R3209-31	Spacer 1/4"	cad	3.13 ☉
X.	R3209-38P	Spacer 1/2"	park	3.13 ☉
"	R3209-38	Spacer 1/2"	cad	3.13 ☉
Y.	R0259P	Lockwasher	park	0.25 ☉
"	R0259	Lockwasher	zinc	0.25 ☉
"	R0259C	Lockwasher	chrome	0.38 ☉
Z.	R0117P	Nut	park	1.19 ☉
"	R0117M	Nut	cad	1.25 ☉
"	R0117C	Nut	chrome	0.94 ☉

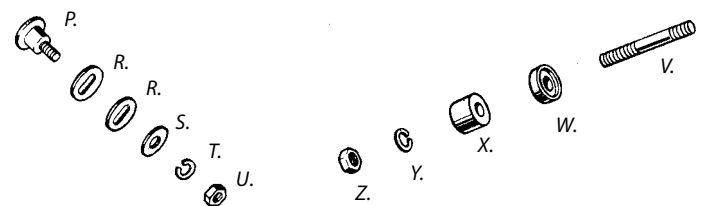

Solo Seat Mounting Kit

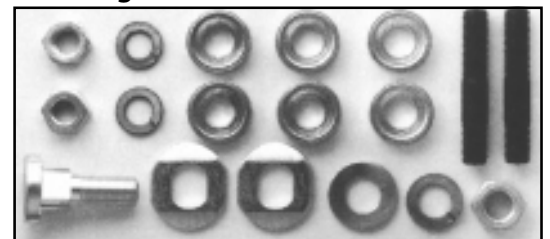

Includes bolts and washers, rear studs with spacers, etc. (as pictured)

	C9696-18	parkerized kit	40.00 ☉
	C8873-18	cad plated kit	40.63 ☉

Seat

Seat Post Springs and Parts

A.	R3128-31	Spring, cushion	5-1/8"	12.00
B.	3129-31	Spring, cushion	2-3/4"	5.00 ☼
"	R3129-31C	Spring, extra heavy		11.00
"	R3129-31A	Spring, extra heavy, with collars		18.00
C.	R3133-30	Spring, recoil	1"	3.50 ☼
D.	R3135-30	Spring, auxiliary	2-15/16"	4.00
E.	R186-10	Spring, auxiliary	2-7/16"	5.00

Note: auxiliary springs fit in the plunger above the rod.

F.	R3138-31	Collar guide, standard springs		5.63 ☼
"	R3138-29A	Collar guide, heavy springs		5.63 ☼
G.	3137-41M	Rod, 14 3/4" / 37,5 cm		15.00 ☼
"	R3137-30	Rod, 15 3/4" / 40 cm standard length		41.25 ☼
"	R3137-30S	Rod, 16 3/4" / 42,5 cm		31.00 ☼
H.	3143-25	Nut, seat post rod		3.50 ☼
I.	3144-25	Nut, rod lock	park	5.00 ☼
J.	R0269P	Lockwasher	park	1.50 ☼
"	R0269	Lockwasher	zinc	0.30 ☼
K.	3147-29A	Nut, spring adjusting		3.50 ☼
L.	0129	Nut, lock	park	1.50 ☼
"	R0129P	Nut, lock	park	1.44 ☼

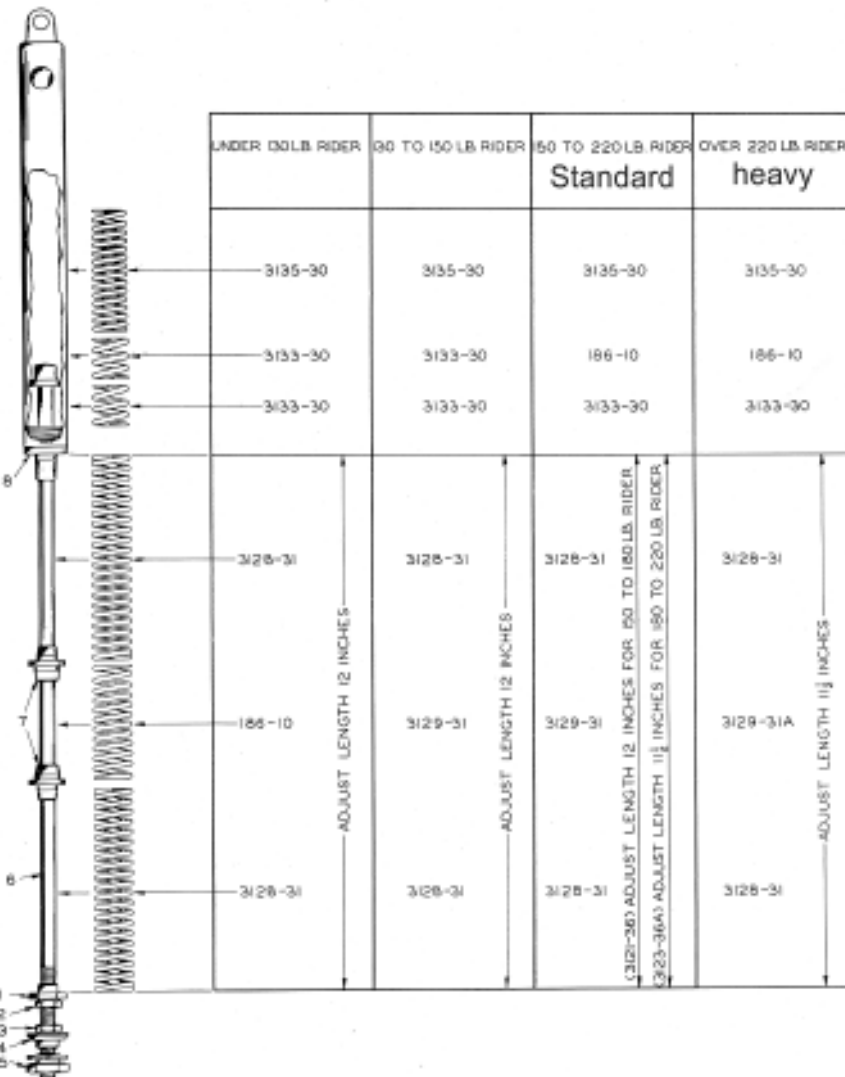
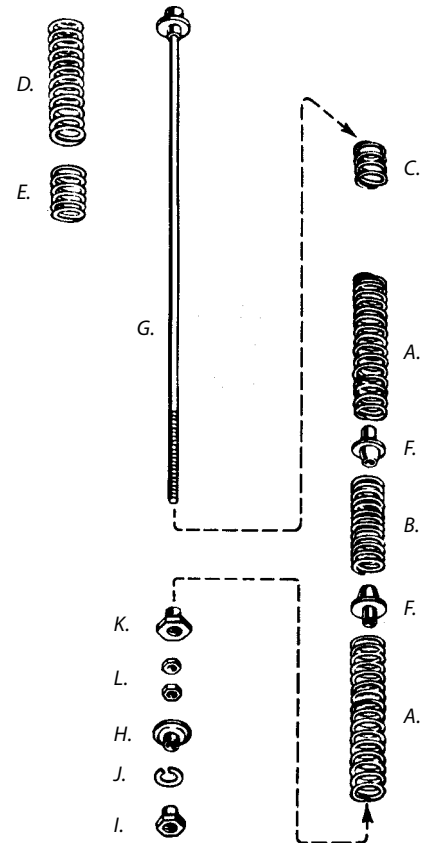

Seat Post Spring Sets

Seat post spring sets are available standard or extra heavy, depending on weight of rider, see chart. Each set also includes two spring guides, except set **3128-29**, which includes only one (as original).

Standard spring sets

3128-29	Lower springs	(3)	32.00 ☼
R3128-31A	Complete set	(6)	37.00
R3128-31A.5pack		5 Sets	155.00

Extra heavy spring sets

R3128-29A	Lower springs	(3)	33.00
R3128-31B	Complete set	(6)	45.00
R3128-31B.5pack		5 Sets	185.00



Buddy Seat Parts '36-'64

A.	R11240-41B	Set buddy seat clips, with bolts		42.00
	C3157-11	Bolt kit (one side)	park	26.25 ☉
B.	13301-36	Front bracket	'36-'57	27.50 ☉
C.	2823-26	Bolt, bracket to T-bar	park	7.00 ☉
"	R2823-26P	Bolt kit, bracket to T-bar	park	5.00 ☉
"	R2823-26	Bolt kit, bracket to T-bar	cad	5.00 ☉
"	R2823-26C	Bolt kit, bracket to T-bar	chrome	6.25 ☉
	52602-55	Stud, spring mount (used with dual mufflers only)	'55-'57 park	18.00 ☉
	13314-33	Bolt, clip 1-3/8"	park	n.a. ☉
D.	13322-33N	Spring, buddy seat	'36-'57 green	20.00 ☉
"	13322-33	Spring, buddy seat	'36-'57 black	25.00 ☉
E.	2641-30	Nut, spring yoke	park	2.00 ☉
"	2641-30C	Nut, spring yoke	chrome	3.00 ☉
G.	R13341-36C	Hook, spring yoke	chrome	n.a.
H.	R0224P	Washer, front bolt	park	0.63 ☉
"	R0224	Washer, front bolt	cad	0.63 ☉
"	R0224C	Washer, front bolt	chrome	0.88 ☉
I.	R0261P	Lockwasher, front bolt	park	0.25 ☉
"	R0261	Lockwasher, front bolt	zinc	0.25 ☉
"	R0261C	Lockwasher, front bolt	chrome	0.38 ☉
J.	0129	Nut, front bolt	park	1.50 ☉
"	R0129P	Nut, front bolt	park	1.44 ☉
"	R0129	Nut, front bolt	cad	1.56 ☉
"	R0129C	Nut, front bolt	chrome	1.75 ☉
	52541-59	Plate, rear bracket	frame mounted seat	10.00 ☉
	52550-59	Front bracket	frame mounted seat	27.00 ☉
	52554-59	Rear bracket	frame mounted seat	27.00 ☉

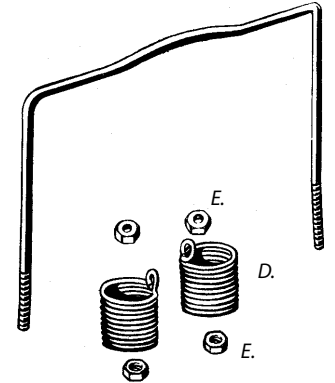
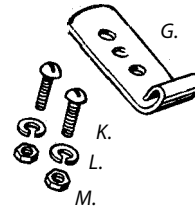
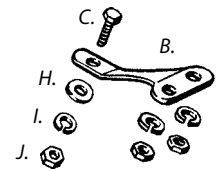
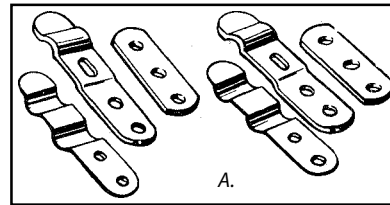

K.	R051P	Screw, yoke hook	park	1.44 ☉
"	R051	Screw, yoke hook	cad	1.50 ☉
"	R051C	Screw, yoke hook	chrome	2.63 ☉
L.	R0256P	Lockwasher, yoke hook	park	0.25 ☉
"	R0256	Lockwasher, yoke hook	zinc	0.25 ☉
"	R0256C	Lockwasher, yoke hook	chrome	0.38 ☉
M.	0108	Nut, yoke hook	park	1.50 ☉
"	R0108P	Nut, yoke hook	park	1.13 ☉
"	R0108M	Nut, yoke hook	cad	1.19 ☉
"	R0108C	Nut, yoke hook	chrome	0.88 ☉

Buddy Seat Footrests

N.	R13344-33	Set footboard extensions	park	n.a. ☉
"	R13344-33C	Set footboard extensions	chrome	n.a. ☉
O.	R13353-41	Bolt, footrest	early style cad	5.00 ☉
P.	R13354-41	Pin, footrest	early style cad	3.75 ☉
R.	R52684-55	Spacer (left side)	'55-'64 cad	2.50 ☉
S.	R13351-41	Rubber, footrest	early style black	11.00 ☉
	C9722-18	Set bolts, nuts, pins	early style park	24.38 ☉
	C8774-18	Set bolts, nuts, pins	early style cad	25.00 ☉
T.	R50940-52	Rubber, footrest	late style black	6.00
"	50940-52T	Rubber, footrest	"Harley-Davidson"	n.a.
"	R50940-52W	Rubber, footrest	late style white	n.a.
	C9965-4	Mounting bolt kit	late style cad	14.38 ☉
	C8850-4	Mounting bolt kit	late style chrome	18.75 ☉

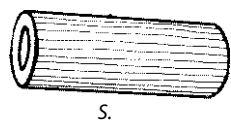
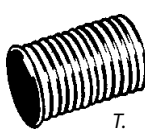
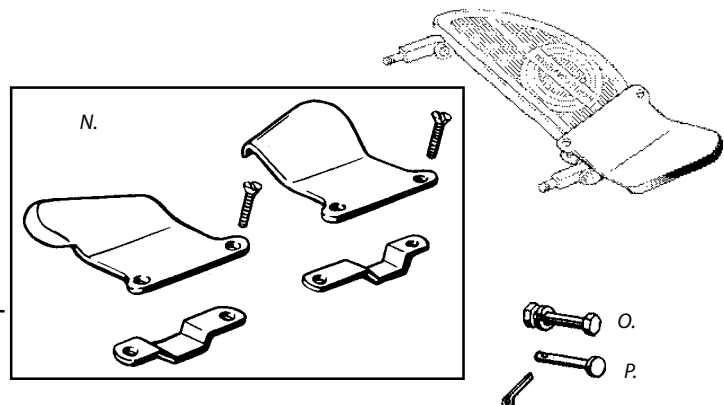

R49100-58C	Set of safety guard footrests	chrome	47.00
-------------------	-------------------------------	--------	-------

C8774-18

Handlebar

Handlebar Control Parts

C2304-2	Handlebar plunger	'49-'53	24.06 ☼
C3083-6	Grip retainers w.screws cad	'49-'53	48.13 ☼
C2181-6	Grip retainers w.screws chrome	'49-'53	48.13 ☼
<hr/>			
C9514-2	Handlebar plunger	'54-'74	20.63 ☼
C8924-8	Roller and pin kit	'54-'74	20.63 ☼
E. 305-15	Plunger pin	'54-'74	1.50 ☼
F. R3320-10	Roller, plain	'54-'74	2.50 ☼
G. 56216-53	Spring, handlebar grip	'54-'74	5.00 ☼
R56288-53	End nut 3/4"-16	'54-'74	8.75 ☼

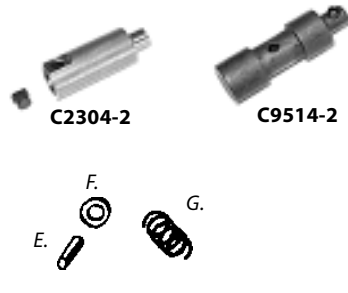

Handlebar Control Cables

Control cables include inner cable and end plug

H. R56528-49	Plastic covered 130 cm	'49-'53	31.00 ☼
" R56502-54	Plastic covered 130cm	'54-'74	31.00 ☼
I. R56392-49	Inner cable only 150 cm	'49-'74	n.a. ☼
J. R56410-47	Plug only, control coil	'49-'53	3.00 ☼
" 56410-53	Plug only, control coil	'54-'74	9.00 ☼
" R56410-53	Plug only, control coil	'54-'74	3.00 ☼
K. R3333-31	Screw, control coil plug	'49-'74	1.25 ☼

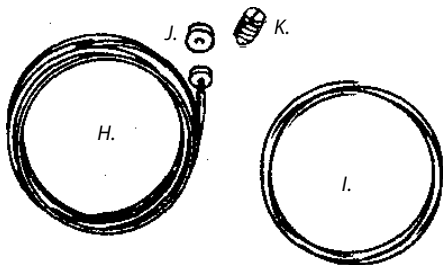

Cable Clamps

L. R3370-36	Connection, carburetor cad	14.38 ☼
" R3370-36S	Connection, oversize for worn levers	15.00 ☼
R3371-48	Bracket, throttle cable 1948 park	26.88 ☼
C3215-4	Bracket, throttle cable '49-'53 park	25.00 ☼
M. 4160-28	Throttle cable clamp '54 black	19.00 ☼
" R4160-28	Throttle cable clamp '54 park	13.75 ☼
N. 56609-52	Throttle cable clamp '52-'65 cad	3.50 ☼

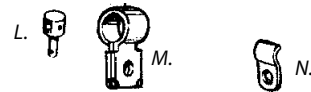

O. R3393-46	Clamp, timer cable/frame '46-'48 park	6.50 ☼
" R56626-49	Clamp, timer cable/frame '49-'64 zinc	6.50 ☼
P. R9957	Timer cable clamp '50-'64 cad	8.13 ☼
R. R4726-47	Timer cable bracket '47-'53 cad	n.a. ☼
S. R56628-54	Timer cable bracket '54-'64 cad (use with "trumpet" horn)	11.00 ☼

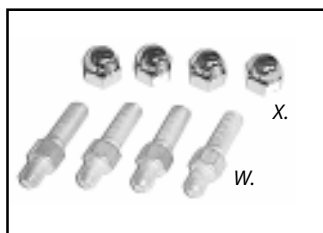

C2147-8



W. R56167-49	Stud, riser mounting	'49-'59	7.19 ☼
X. R7736	Acorn nut chrome	'49-'59	3.75 ☼
C2147-8	Set studs and nuts	'49-'59	39.06 ☼
C2680-4	Riser mounting kit (includes bolts 56154-49 and nuts 7900)	'49-'59	35.31 ☼
45732-60	Bushing, fork bracket	'60-'72	15.00 ☼
56154-52	Bolt, riser mounting	'60-'72	6.00 ☼
Z. R56158-49	Rubber bushing	'49-up	8.50
" R56158-49S	Rubber bushing +.007"	'49-up	9.00

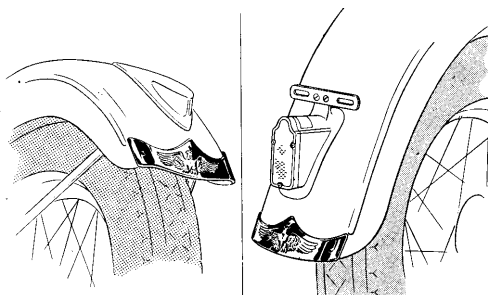

59282-85T	Eagle fender tip	21.5 cm width	38.00
------------------	------------------	---------------	-------

Rear Fender

3741-34	Rear fender end brace bracket	'36-'57	17.00 €
3752-30P	Pin, rear fender hinge park	'36-'79	6.00 €

Carriage bolts for rear end

A. 3743-42	Bolt with nut	'42-'57	3.00 €
" R3743-42P	Bolt, with nut park	'42-'57	3.31 €
" R3743-42	Bolt, with nut cad	'42-'57	3.31 €
" R3743-42C	Bolt, with nut chrome	'42-'57	4.06 €



Countersunk head screw

B. R3749-30P	Screw, with nut park	'36-'57	6.00 €
" R3749-30	Screw, with nut cad	'36-'57	6.00 €
" R3749-30C	Screw, with nut chrome	'36-'57	7.00 €
R0259P	Lockwasher park		0.25 €
R0259	Lockwasher zinc		0.25 €
R0259C	Lockwasher chrome		0.38 €
R0117P	Nut park		1.19 €
R0117M	Nut cad		1.25 €
R0117C	Nut chrome		0.94 €

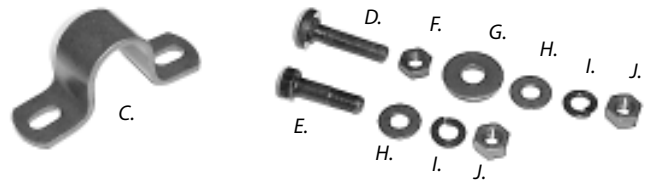
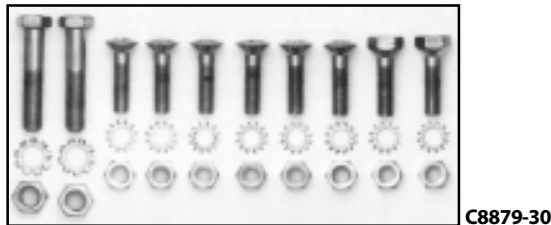
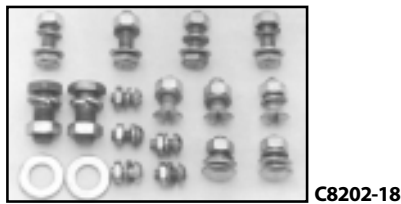

C. R3747-36	Rear fender clamp 1" rise	park	n.a. €
" R3747-36A	Rear fender clamp 1-1/4" rise	park	n.a. €

Clamps to fender hardware '47-'57

C2493-6	Mounting kit park	'36-'48	50.00 €
C3220-6	Mounting kit chrome	'36-'48	62.50 €

D. R3743-47	Carriage bolt, upper black		7.00 €
--------------------	----------------------------	--	--------

Upper bolts are correct length for mounting buddy seat bracket and safety guard.

E. R3748-36P	Bolt, lower 13/16"	park	5.31 €
" R13035-36P	Bolt, lower 1"	park	5.63 €
F. R0117BP	Nut park		1.25 €
" R0117B	Nut cad		1.38 €
" R0117BC	Nut chrome		1.50 €
G. R0223P	Washer park		1.13 €
" R0223	Washer cad		1.13 €
" R0223C	Washer chrome		1.50 €
H. R0214P	Washer park		0.50 €
" R0214	Washer cad		0.50 €
" R0214C	Washer chrome		0.50 €
I. R0259P	Lockwasher park		0.25 €
" R0259	Lockwasher zinc		0.25 €
" R0259C	Lockwasher chrome		0.38 €
J. R0117P	Nut park		1.19 €
" R0117M	Nut cad		1.25 €
" R0117C	Nut chrome		0.94 €

Rear Fender Mounting Kits '36-'57

Includes all parts pictured.

C9707-18	Rear fender mounting kit park	43.75 €
C8202-18	Rear fender mounting kit cad	43.75 €
C9708-18	Rear fender mounting kit chrome	58.75 €

Rear Fender Mounting Kits '58-'80

C2625-30	Stock mounting kit cad	31.25 €
C8879-30	Stock mounting kit chrome	42.50 €
C9638-30	Acorn mounting kit chrome	45.00 €

N. 59995-55A	License plate bracket ass.	'55-'71	50.00 €
59997-55	Bracket only	'55-'71	35.00 €
O. 59999-55A	Support only	'55-'71	12.00 €

License plate mounting kit, to mount plate on bracket

Chrome plated hardware with rubber insulators to eliminate vibration.

C7815-4	Kit with acorn nuts	10.00 €
C8475-4	Kit with cap nuts	8.75 €
C9871-10	Kit with flat head Allen screws	11.88 €
C9872-10	Kit with button head Allen screws	8.00 €

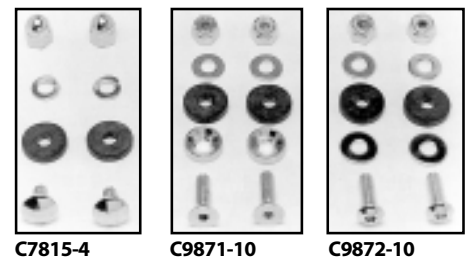
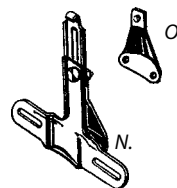

Front Fender

C2290-8	Mounting kit park	'51-'78	11.88 €
C2291-8	Mounting kit cad	'51-'78	11.88 €
C2292-8	Mounting kit chrome	'51-'78	15.31 €



R11530-46	Pair of nameplates "DeLuxe"	28.00
R91583-52	Pair of nameplates "OHV DeLuxe"	28.00

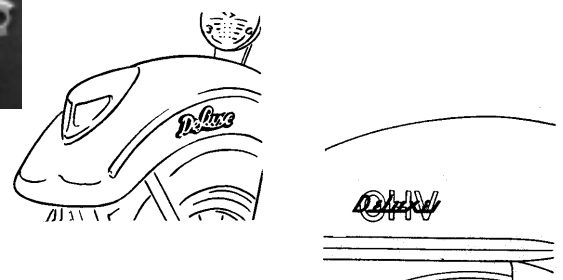

Chainguards

C.	R3802-36	Reinforcement, inner chain guard		17.50
D.	R3810-36	Cover, clutch	'36-'64 black	n.a.
"	R3810-36C	Cover, clutch	'36-'64 chrome	14.00 ✪
"	R3810-36C.bird	Cover, bird style	'36-'64 chrome	19.00 ✪
E.	R3811-36	Cover, inspection	'36-'64 black	n.a. ✪
"	R3811-36C	Cover, inspection	'36-'64 chrome	n.a. ✪
F.	R3808-36	Cork		3.00 ✪
"	R3808-36-X	Cork/rubber blend		5.50 ✪
G.	R3810-36A	Cork/rubber blend		3.00 ✪
H.	3811-36A	Cork		1.50 ✪
"	R3811-36A	Cork/rubber blend		1.00 ✪
"	R3808-36set	Set corks and gaskets	'36-'64	40.00 ✪
J.	R60629-55	Gasket, engine to primary	'55-'64	2.50 ✪
K.	R048AP	Screw	park	0.94 ✪
"	R048A	Screw	cad	1.00 ✪
"	R048AC	Screw	chrome	1.75 ✪
L.	R037P	Screw	park	0.63 ✪
"	R037	Screw	cad	0.69 ✪
"	R037C	Screw	chrome	1.13 ✪
M.	R0254P	Lockwasher	park	0.25 ✪
"	R0254	Lockwasher	zinc	0.20 ✪
"	R0254C	Lockwasher	chrome	0.38 ✪

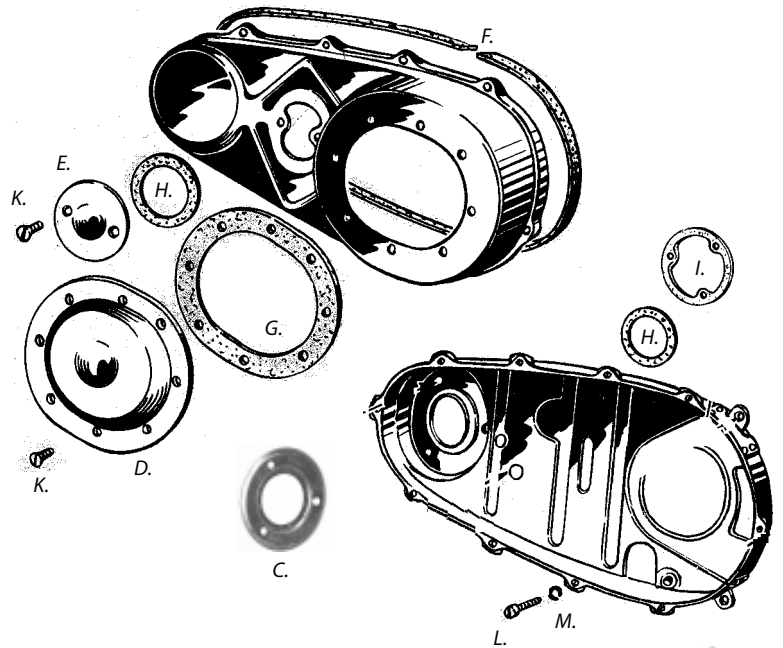

Inner Chainguard Mounting Kits

C3045-14	Mounting kit	'36-'54 park	26.25 ✪
C7811-14	Mounting kit	'36-'54 cad	26.25 ✪
C7812-12	Mounting kit	'55-'64 cad	30.00 ✪
C8798-12	Mounting kit	'65-'69 cad	29.38 ✪
C9601-10	Rear bolts and springs	'36-'64 park	11.25 ✪
C2071-10	Rear bolts and springs	'36-'64 chrome	15.63 ✪

Outer Chainguard Screw Kits '36-'64

Kits include 10 outer screws with lockwashers and 10 cover screws.

C9724-30	Slotted head screws	park/cad	18.75 ✪
C8156-30	Slotted head screws	cad	20.63 ✪
C8155-30	Slotted head screws	chrome	26.25 ✪
C3067-30	Phillips head screws	park/cad	18.75 ✪
C3068-30	Phillips head screws	cad	18.75 ✪
C8756-30	Allen head screws	chrome	25.63 ✪
C8756-30-P	Polished Allen head screws	chrome	27.50 ✪
C7414-20	Acorn head screws	chrome	68.75 ✪
C8468-20	Cap head screws	chrome	71.25 ✪

'65-'69 Kits include primary and inspection cover screws (12)

C8800-12	Stock (slotted) kit	cad	26.25 ✪
C8799-12	Stock (slotted) kit	chrome	31.25 ✪
C7146-12	Acorn screw kit	chrome	42.50 ✪
C8452-12	Cap screw kit	chrome	43.75 ✪

R3803-36C

R3803-36C	Nipple, drain tube	'36-'64	8.13 ✪	
O.	R3803-36D	Primary drain tube	cad '36-'57	n.a. ✪
P.	R60546-58	Primary drain tube	cad '58	28.00 ✪
P.	R60546-59	Primary drain tube	cad '59-'64	28.00 ✪



C7811-14



C7812-12

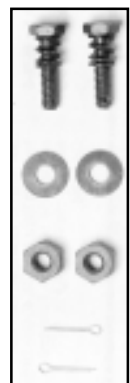

C9601-10



C9724-30

R.	60650-54	Plug, chain housing	'54-'64	4.00 ✪
	60649-60	Gasket, chain housing plug	'54-'64	1.00
S.	R543-48	Breather pipe, stud	'48-'57 + '64	35.00 ✪
U.	R543-39	Rubber washer, oil deflector	'39-'57	1.80 ✪
V.	R24913-58	Breather pipe	'58-'63	32.00
W.	24918-58	Breather nipple	'58-'63	17.00 ✪
"	R24918-58	Breather nipple	'58-'63	8.50 ✪
	C3113-5	Breather pipe assembly	'58-'63	75.00 ✪

Rear Chainguard '36-'57

A.	R3817-36B	Rear chainguard	black	n.a.
"	R3817-36C	Rear chainguard	chrome	n.a.
B.	R0208P	Washer	park	0.38 ☼
"	R0208Z	Washer	zinc	0.30 ☼
"	R0208C	Washer	chrome	0.50 ☼
C.	R0256P	Lockwasher	park	0.25 ☼
"	R0256Z	Lockwasher	zinc	0.25 ☼
"	R0256C	Lockwasher	chrome	0.38 ☼
D.	0108	Nut	park	1.50 ☼
"	R0108P	Nut	park	1.13 ☼
"	R0108M	Nut	cad	1.19 ☼
"	R0108C	Nut	chrome	0.88 ☼

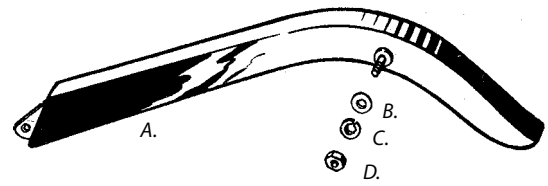

Rear Shock Parts

E.	54515-58A	Stud, shock absorber, upper	'58-'66	45.00 ☼
"	R54515-58A	Stud, shock absorber, upper	'58-'66	13.50 ☼
"	R54515-58C	Studs and washer set	chrome	24.00
F.	R54517-58	Stud, shock absorber, lower	'58-'65	13.50 ☼
"	R54517-58C	Studs and washer set	chrome	24.00
G.	85210-42A	Bushing, rear shock	rubber	11.00
"	R85210-42A	Bushing, rear shock	rubber	3.00
"	R7405-42C	Bushing, rear shock (single)	rubber	n.a.

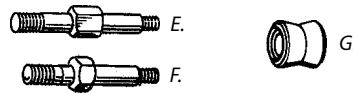

Tank Mounting Hardware

I.	R3506-36	Stud, tank mounting	park	3.75 ☼
J.	R3529-36P	Bolt, upper front	park	3.44 ☼
"	R3529-36C	Bolt, upper front	cad	3.56 ☼
"	R3529-36C	Bolt, upper front	chrome	3.75 ☼
K.	R066P	Bolt, lower front	park	2.19 ☼
"	R066Z	Bolt, lower front	zinc	0.75 ☼
"	R066C	Bolt, lower front	chrome	1.30 ☼
L.	R0117P	Nut	park	1.19 ☼
"	R0117M	Nut	cad	1.25 ☼
"	R0117C	Nut	chrome	0.94 ☼
M.	R0214P	Washer	park	0.50 ☼
"	R0214	Washer	cad	0.50 ☼
"	R0214C	Washer	chrome	0.65 ☼
N.	R0259P	Lockwasher	park	0.25 ☼
"	R0259Z	Lockwasher	zinc	0.25 ☼
"	R0259C	Lockwasher	chrome	0.38 ☼

Tank Mounting Kits

C9893-18	Tank mounting kit	park	15.31 ☼
C9892-18	Tank mounting kit	cad	15.62 ☼
C9891-18	Tank mounting kit	chrome	16.88 ☼

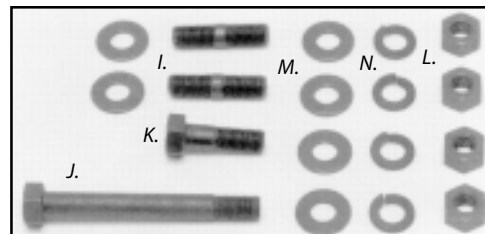

C9893-18

COLONY

3502-39	Tank top filler strip	'39-'65	16.00 ☼
R3502-39	Tank top filler strip	'39-'65	6.00

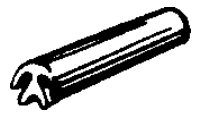

Petrol Tank Caps

O.	R3507-36C	Petrol tank cap	chrome	n.a.
Low model tank cap, includes rubber gasket.				
P.	R3507-43C	Petrol tank cap	chrome	16.50
High model tank cap, includes rubber gasket.				
	R61103-65	Petrol tank cap	chrome	7.00
Fits '65-'72 left side tank, non vented.				

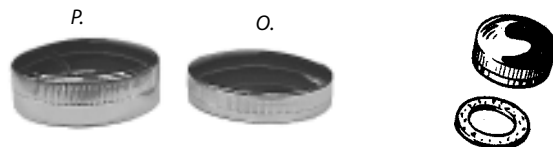

Capcover-65 Cover chrome 9.00
Fits over all '36-'72 tank caps (approx. 65 mm I.D.)



Tanks

Petrol Lines

A.	R3607-41A	Petrol line		'42-'49	n.a. ✱
"	R3607-41AC	Petrol line	chrome	'42-'49	n.a. ✱
B.	R62352-50	Petrol line		'50-'65	n.a. ✱
"	R62352-50C	Petrol line	chrome	'50-'65	n.a. ✱
C.	R3606-48A	Cross-over line		'48	n.a. ✱
D.	R62355-49	Cross-over line		'49-'56	n.a. ✱
E.	R62355-57	Cross-over line		'57-'65	32.00 ✱
"	R62355-57C	Cross-over line	chrome	'57-'65	33.00 ✱
	R3609-40	Nipple, cross-over lines		'40-'65	n.a. ✱
F.	R3612-39	Nut, petrol line		'39-'49	n.a. ✱
G.	R62361-50	Nut, petrol line		'50-'65	4.50 ✱
H.	R62360-50	Rubber, petrol line		'50-'65	1.00 ✱

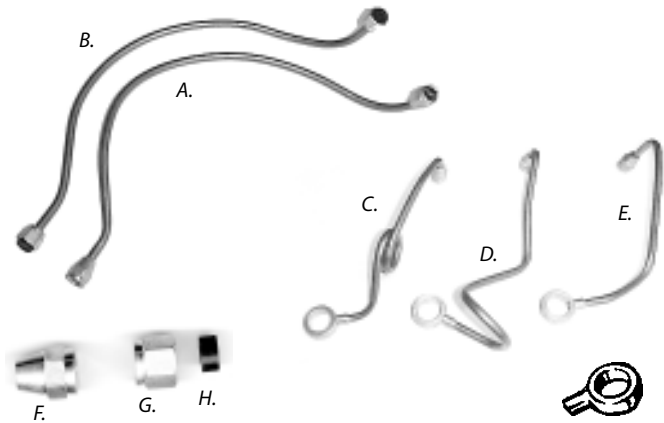

Flexible Hose Fittings

I.	R3612-40C	'40-'49 valve/filter, '40-'65 right tank			9.38 ✱
"	R3612-50C	'50-'65 valve and filter			9.38 ✱
J.	R3609-41C	Cross-over fitting			10.63 ✱
	C3340-3	Set of 3 fittings	'40-'49	cad	28.75 ✱
	C2821-3	Set of 3 fittings	'40-'49	chrome	30.00 ✱
	C3337-3	Set of 3 fittings	'50-'65	cad	28.75 ✱
	C7807-3	Set of 3 fittings	'50-'65	chrome	30.00 ✱
K.	C3339-1	Fits Linkert carb (without filter)	cad		9.38 ✱
"	C7158-2	Fits Linkert carb (without filter)	chrome		9.38 ✱



Petrol Filters

L.	R3623-41M	Petrol filter	'42-'49	zinc	50.00
"	R3623-41MC	Petrol filter	'42-'49	chrome	55.00
"	C9660-1	Petrol filter Colony	'42-'49	cad	90.00 ✱
LA.	C9662-1	Petrol filter Colony	'50-'65	cad	90.00 ✱
	C2212-1	Petrol filter, use with neoprene fuel line			88.75 ✱

Petrol filters include screen, two corks and cap.

M.	R3627-32	Screen, with corks	'42-'65		20.00 ✱
N.	R3629-32	Cap, petrol filter	cad	'42-'65	15.00 ✱
"	R3629-32C	Cap, petrol filter	chrome	'42-'65	17.50 ✱
O.	3633-32	Washer, cork	'42-'65		2.00 ✱
"	R3633-32	Washer, cork	'42-'65		1.13 ✱
P.	R3612-09	Nut only	cad		5.00 ✱
R.	R3617-15	Nipple only, for repairs	cad		5.50 ✱

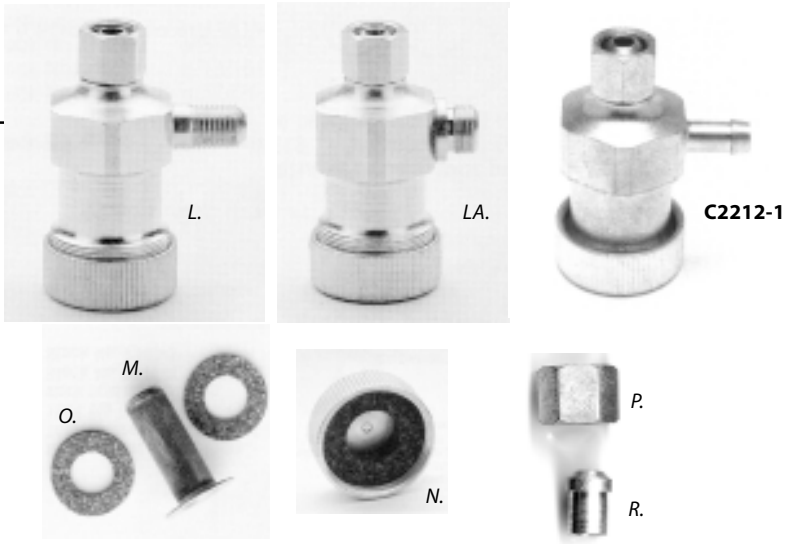

Petrol Valve

S.	R3641-40kit	Petrol valve, complete	'40-'49		72.50
"	R3641-50kit	Petrol valve, complete	'50-'65		72.50

This valve is for 750cc models and will give very little reserve supply. Complete valve includes all parts pictured, except extension knob

T.	C7801-2	Extension knob	chrome	'49-'65	13.75 ✱
U.	R018	Screw	cad		0.63 ✱
"	R018C	Screw	chrome		0.75 ✱
V.	R0352	Lockwasher	zinc		0.20 ✱
W.	R3633-40	Rod, adjusting	cad	'40-'65	18.50

This rod is for 750cc models and will give very little reserve petrol supply

X.	4764-26	Spring, adjusting rod	'40-'65		2.00 ✱
Y.	R3634-40	Rubber seal	'40-'65		7.81 ✱
Z.	R3635-40	Washer, rod	'40-'65		1.00 ✱
AA.	R3636-40P	Cap, upper	park	'40-'65	8.75 ✱
"	R3636-40	Cap, upper	cad	'40-'65	8.75 ✱
AB.	R3637-40P	Knob, adjusting	park	'40-'65	11.25 ✱
"	R3637-40B	Knob, adjusting	black	'40-'65	5.00
"	R3637-40C	Knob, adjusting	chrome	'40-'65	12.50 ✱
AC.	R3638-40	Washer, nipple	copper	'40-'65	1.70 ✱
AD.	R3639-40	Nipple, gas valve	cad	'40-'49	25.00
"	R3639-50	Nipple, gas valve	cad	'50-'65	25.00

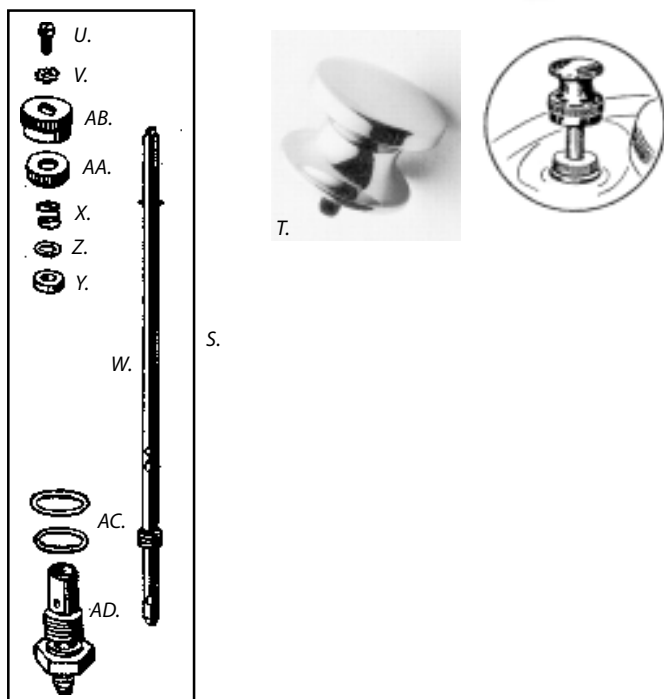

Tool Box

Tool box, ribbed style '40-'57, fits '40-'64

D.	R3452-40	Tool box , with keys	black		85.00	
"	R3452-40C	Tool box , with keys	chrome		62.50	
E.	3464-26	Key, tool box	'36-'54		8.00	☉
F.	R3457-40B	Tool box mount, weld on frame	'40-'51		n.a.	
	R2886-41	Small bracket only	'40-'51		n.a.	
G.	R64450-55	Tool box mount, weld on frame	'52-'57		28.00	☉
H.	R3805-30AP	Screw, tool box	'40-'62	park	5.00	☉
"	R3805-30A	Screw, tool box	'40-'62	cad	5.00	☉
I.	R3478-35P	Washer, screw	'40-'62	park	2.50	☉
"	R3478-35	Washer, screw	'40-'62	cad	2.50	☉
J.	3457-40	Spacer, tool box	'40-'57	park	6.00	☉
"	R3457-40	Spacer, tool box	'40-'57	cad	6.25	☉
K.	R3458-40P	Screw, tool box	'40-'57	park	5.63	☉
L.	R0259P	Lockwasher	'40-'57	park	0.25	☉
M.	R0117P	Nut	'40-'57	park	1.19	☉
	C9669-9	Mounting kit	'40-'54	park	26.25	☉
	C8206-9	Mounting kit	'40-'54	cad	28.13	☉
	C2002-13	Mounting kit	'55-'57	cad	39.06	☉
	R64500-52A	Wing stud only	'55-'57	cad	11.25	☉
	C2003-6	Mounting kit	'58-early'62	cad	15.00	☉
	C2004-6	Mounting kit	late'62-'64	cad	18.13	☉
	R64503-58AP	Cover screw only	'58-'64	park	7.50	☉

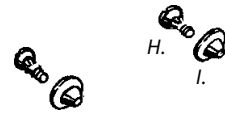
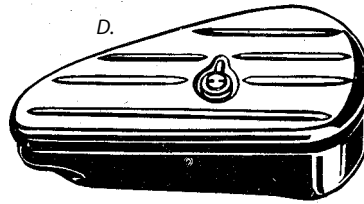

C8206-9

C2004-6



C2002-13

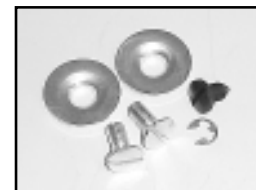

C2003-6

Oil Tank

Oil Tank Mounting Parts

A.	R3503-36AC	Mounting plate	'36-'64 chrome	21.00
"	R3503-36AC.5pack	5 Oil tank mounting plates		80.00
B.	R3503-36BC	Bracket	'36-'57 chrome	5.00
"	R3503-36BC.5pack	5 Mounting plate brackets		20.00
C.	R3503-36CP	Spacer	'36-'64 park	3.13 ☼
"	R3503-36C	Spacer	'36-'64 cad	3.13 ☼
"	R3503-36CC	Spacer	'36-'64 chrome	4.06 ☼
D.	R3748-26P	Bolt, plate to frame	'36-'64 park	2.50 ☼
"	R3748-26	Bolt, plate to frame	'36-'64 cad	2.50 ☼
"	R3748-26C	Bolt, plate to frame	'36-'64 chrome	2.50 ☼
E.	R3749-30P	Screw with nut	'36-'57 park	6.00 ☼
"	R3749-30	Screw with nut	'36-'57 cad	6.00 ☼
"	R3749-30C	Screw with nut	'36-'57 chrome	7.00 ☼
F.	R064P	Bolt	park	1.81 ☼
"	R064	Bolt	cad	1.88 ☼
"	R064C	Bolt	chrome	2.13 ☼
G.	R0117P	Nut	park	1.19 ☼
"	R0117M	Nut	cad	1.25 ☼
"	R0117C	Nut	chrome	0.94 ☼
H.	R0259P	Lockwasher	park	0.25 ☼
"	R0259	Lockwasher	zinc	0.25 ☼
"	R0259C	Lockwasher	chrome	0.38 ☼

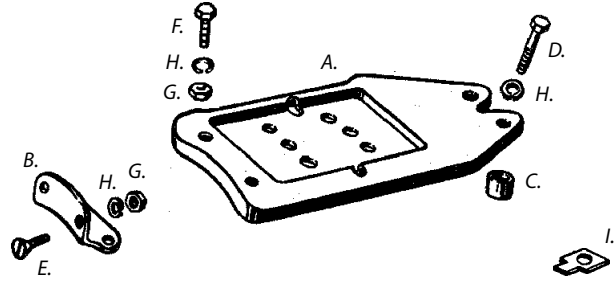

I.	R62531-60	Lockwasher	'60-'64 cad	2.50 ☼
"	R62531-60C	Lockwasher	'60-'64 chrome	2.75 ☼

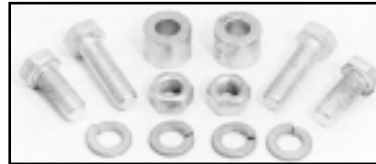

C9206-12



C8213-8

C9667-8	Mounting kit	'36-'57 park	18.13 ☼
C8213-8	Mounting kit	'36-'57 cad	18.75 ☼
C9602-8	Mounting kit	'36-'57 chrome	21.25 ☼
C9206-12	Mounting kit	'58-'64 cad	22.50 ☼
C9205-12	Mounting kit	'58-'64 chrome	27.50 ☼

C2904-2	Filler cap and gauge cad	'41-'48	67.25 ☼
C2908-2	Filler cap and gauge park	'41-'48	67.25 ☼

C7354-2 Custom style oil tank dipstick 27.50 ☼

The hex size and shallow crown are similar to a Knucklehead rocker shaft nut. Includes O-ring.

R3504-36A	Gasket, oil tank cap		2.50 ☼
------------------	----------------------	--	--------



R3504-36A

62610-52TA	Cap, oil tank assembly chrome	'65-'82	70.00
	(also '58-'64 side mounted oil tank)		
R62617-52	Gasket, for above oil tank cap	'65-'82	2.50 ☼
R62628-52	Gasket, for above oil tank cap	'65-'82	3.00
R63839-53	Filter element	'65-'82	4.00 ☼
C2321-4	Rear chain oiler fitting	'54-'62	20.75 ☼
63610-53A	Adjusting screw, rear chain oiler	'54-'62	7.00 ☼
R0201A	Washer, brass	'54-'62	0.50 ☼
63615-54	Rubber washer, chain oiler	'54-'62	2.50 ☼



62610-52TA

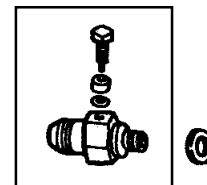

C2321-4

Drain Plugs

R2326-38P	Drain plug	park	6.00 ☼
R2326-38	Drain plug	cad	6.00 ☼
R2326-38C	Drain plug	chrome	8.50 ☼
R2326-38MAGP	Drain plug with magnet	park	16.00 ☼
R2326-38MAG	Drain plug with magnet	cad	16.00 ☼
R2326-38MAGC	Drain plug with magnet	chrome	18.00 ☼
R3504-38C	Gasket, drain plug		0.55 ☼



R2326-38



R2326-38MAGP

Rigid Frame Oil Lines

R3571-40A	Feed line	cad	'40-'49	n.a. ☉
R3571-50	Feed line	cad	'50-'57	n.a. ☉
R3571-41	Return line	cad	'41-'48	n.a. ☉
R3571-49	Return line	cad	'49-'57	n.a. ☉
R3572-38A	Vent line	cad	'38-'57	n.a. ☉
R3571-40AC	Feed line	chrome	'40-'49	n.a. ☉
R3571-50C	Feed line	chrome	'50-'57	n.a. ☉
R3571-41C	Return line	chrome	'41-'48	n.a. ☉
R3571-49C	Return line	chrome	'49-'57	n.a. ☉
R3572-38AC	Vent line	chrome	'38-'57	n.a. ☉

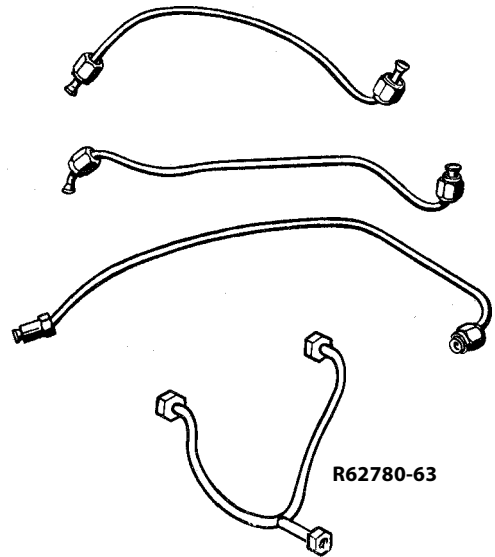

Swing Arm Frame Oil Lines

R63511-58	Feed line	cad	'58-'64	n.a. ☉
R63506-58	Return line	cad	'58-'64	n.a. ☉
R63572-58	Vent line	cad	'58-'64	n.a. ☉
R63511-58C	Feed line	chrome	'58-'64	n.a. ☉
R63506-58C	Return line	chrome	'58-'64	n.a. ☉
R63572-58C	Vent line	chrome	'58-'64	n.a. ☉
R62780-63	Cylinder head feed line		'63-'65	n.a. ☉
R63529-57	Rubber sleeve only		'63-'65	1.00 ☉

R62780-63

Side Mounted Tank Oil Lines

R62675-49	Vent line	cad	'49-'57	n.a. ☉
R63501-49	Return line	cad	'49-'57	n.a. ☉

Oil Line Parts

A. R3577-15P	Nipple	park	5.00 ☉
" R3577-15	Nipple	cad	5.00 ☉
" R3577-15C	Nipple	chrome	6.25 ☉
" 63533-15	Nipple	zinc	9.00 ☉
B. R3581-15	Flare nut	cad	7.00 ☉
" R3581-15C	Flare nut	chrome	8.00 ☉
C. R63526-50	Nipple, pump cover	cad	8.75 ☉ ('50-'57 with filter)
D. 26424-50	Nipple, pump cover	cad	12.00 ☉ ('50-'64 without filter, '58-'64 with filter)
" R26424-50	Nipple, pump cover	cad	6.88 ☉ ('50-'64 without filter, '58-'64 with filter)
R6377	Washer, pump nipples	brass	0.50 ☉ ('50-'67)
F. C2735-1	Nipple, for 3/8" hose	cad	4.69 ☉
" C2070-1	Nipple, for 3/8" hose	chrome	5.00 ☉
G. R3583-15	Cap, oil tank nipple	cad	2.19 ☉
H. R3587-15C	90 degrees connector	chrome	18.00 ☉
R3588-15C	45 degrees connector	chrome	18.00 ☉
R3589-15C	180 degr. connector (straight)	chrome	17.00 ☉

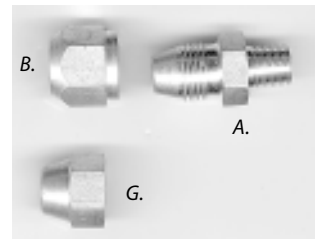

Use on oil tank and oil pump when lines are disconnected, to prevent leakage or contamination during storage.



Oil Filter Lines and Nipples

I. R63500-48	Line, pump to filter	cad	'48-'49	n.a. ☉
" R63500-50	Line, pump to filter	cad	'50-'57	n.a. ☉
" R63500-50C	Line, pump to filter	chrome	'50-'57	n.a. ☉
J. R63503-50	Line, filter to tank	cad	'48-'57	n.a. ☉
" R63503-50C	Line, filter to tank	chrome	'48-'57	n.a. ☉
R63500-58	Line, pump to filter	cad	'58-'64	n.a. ☉
R63500-58C	Line, pump to filter	chrome	'58-'64	n.a. ☉
R63503-58	Line, filter to tank	cad	'58-'64	n.a. ☉
R63503-58C	Line, filter to tank	chrome	'58-'64	n.a. ☉
M. R63524-50	Nipple, oil line to tank	cad	'50-'64	11.25 ☉
N. R63525-50	Nipple, lines to filter	cad	'50-'64	11.25 ☉
C. R63526-50	Nipple, oil line to pump	cad	'50-'57	8.75 ☉
D. 26424-50	Nipple, oil line to pump	cad	'58-'64	12.00 ☉
" R26424-50	Nipple, oil line to pump	cad	'58-'64	6.88 ☉
R63526-40KIT	Nipple set (4)	cad	'48-'57	37.50 ☉
R63526-40CKIT	Nipple set (4)	chrome	'48-'57	41.50 ☉
R63526-58KIT	Nipple set (4)	cad	'58-'64	37.50 ☉
R63526-58CKIT	Nipple set (4)	chrome	'58-'64	41.50 ☉

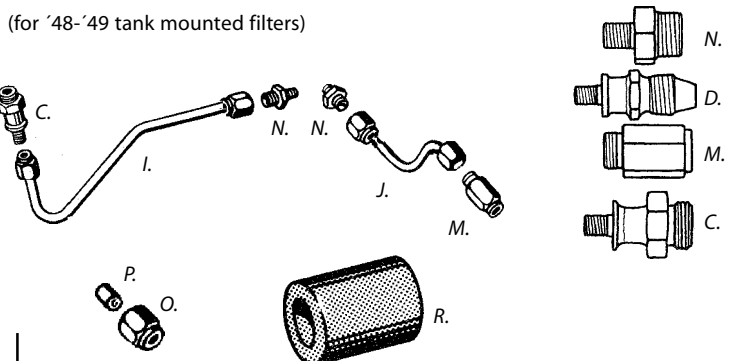

O. R63527-50	Nut, oil line	cad	'50-'64	5.00 ☉
P. R63529-50	Rubber, oil line 3/8"		'50-'64	2.50 ☉
R. 63840-48	Filter element		'50-'64	6.00 ☉
R63809-48	Gasket, filter cap			1.40 ☉
R63809-48-DL	Gasket, filter cap	rubber lip seal		3.30 ☉
R63848-48	Gasket, filter retainer			1.50 ☉
R63858-49	Washer, oil filter nut			0.65 ☉
R63874-50	Gasket, filter bolt			2.00 ☉

Exhaust

A.	R1004-48	Front pipe	bare	'48-'65	75.00 ✪
"	R1004-48C	Front pipe	chrome	'48-'65	92.00 ✪
B.	R1007-48	Rear pipe	bare	'48-'65	75.00 ✪
"	R1007-48C	Rear pipe	chrome	'48-'65	92.00 ✪
C.	R1061-48	Clamp, plain style	stainless	'48-'50	14.50 ✪
"	R1061-48lip	Clamp, flange style	stainless	'48-'64	12.00 ✪
"	R1061-48C	Clamp, repro style	chrome	'48-'64	3.00 ✪
D.	FLFront	Front clamps (2)	park	'36-'65	24.50 ✪
"	FLCFront	Front clamps (2)	chrome	'36-'65	28.50 ✪

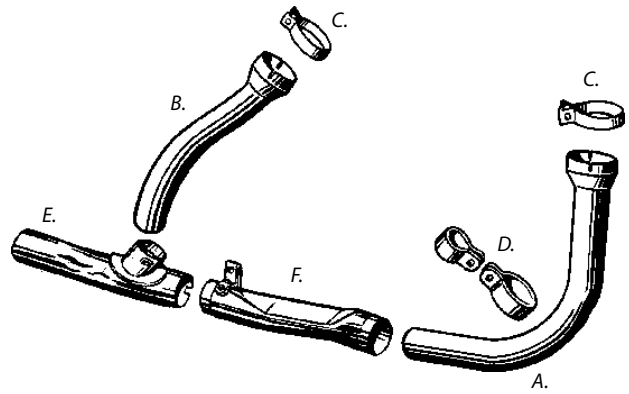

E.	R1007-41A	Y-pipe	bare	'41-'57	73.50 ✪
"	R1007-41AC	Y-pipe	chrome	'41-'57	85.50 ✪
	C2503-4	Bolt and spacer for center pipe/switch			8.75 ✪
"	R65505-61	Y-pipe, dual exhaust bare		'62-'64	64.50 ✪
"	65505-61	Y-pipe, dual exhaust chrome		'62-'64	85.00 ✪
"	R65505-61C	Y-pipe, dual exhaust chrome		'62-'64	76.50 ✪
F.	R1036-36	S-pipe		'36-'64	75.00 ✪
"	R1036-36C	S-pipe	chrome	'36-'64	90.00 ✪
G.	R65538-65	S-Y combination		'65-'69	135.00 ✪
"	R65538-65C	S-Y combination	chrome	'65-'69	148.50 ✪

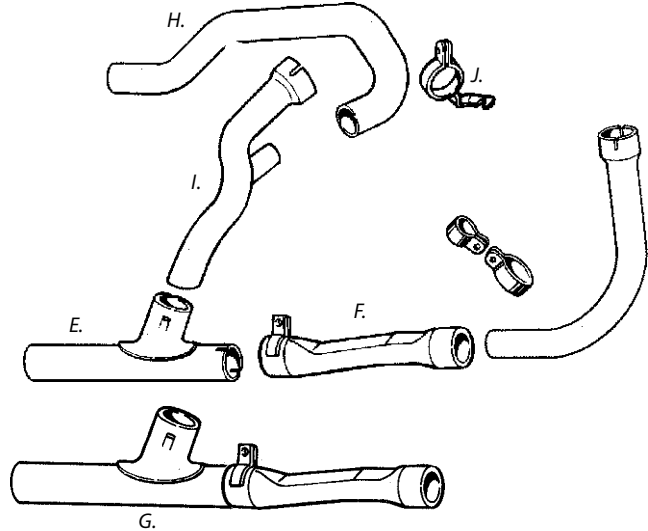

H.	R65494-61C	Cross-over pipe	chrome	'58-'64	110.00 ✪
"	R65494-65C	Cross-over pipe	chrome	'65-'69	n.a. ✪
I.	R65496-61C	Rear pipe with tee	chrome	'58-'65	n.a. ✪
J.	R65510-54	Clamp, dual exhaust		'54-'61	12.00 ✪
"	R65510-54C	Clamp, dual exhaust chrome		'54-'61	13.50 ✪
"	R65510-61	Clamp, dual exhaust		'62-'64	12.00 ✪
"	R65510-61C	Clamp, dual exhaust chrome		'62-'64	13.50 ✪

K.	R1034-41	Muffler	bare	'41-'49	180.00 ✪
"	R1034-41-SP	Muffler, spotwelded	bare	'41-'49	240.00 ✪
"	R1034-41C	Muffler	chrome	'41-'49	195.00 ✪
"	R1034-41C-SP	Muffler, spotwelded	chrome	'41-'49	260.00 ✪
L.	R1034-50	Muffler, long	bare	'50-'57	120.00 ✪
"	R1034-50-SP	Muffler, spotwelded	bare	'50-'57	165.00 ✪
"	R1034-50C	Muffler, long	chrome	'50-'57	140.00 ✪
"	R1034-50C-SP	Muffler, spotwelded	chrome	'50-'57	180.00 ✪

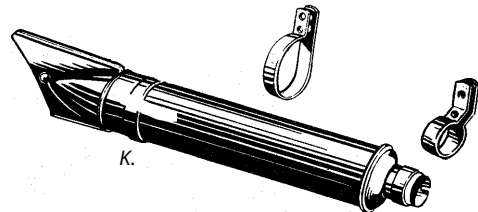

M.	R65240-58C	Muffler, short	chrome	'58-'66	150.00 ✪
"	R65240-58C-SP	Muffler, spotwelded	chrome	'58-'66	170.00 ✪

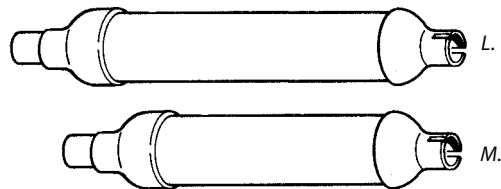

O.	FLRear	Muffler clamps (2)		'41-'57	24.50 ✪
"	FLCRear	Muffler clamps (2)	chrome	'41-'57	28.50 ✪
R.	R1064-50	Rear clamp	stainless steel	'50-'57	23.50 ✪
S.	R1064-41ST	Front clamp	stainless steel	'50-'57	23.50 ✪
P.	R65293-58	Rear clamp	stainless steel	'58-'69	16.00 ✪

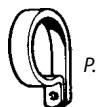
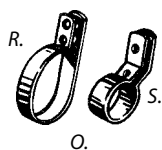

Battery and Parts '36-'64

A.	R4304-29	Battery	6 Volt		n.a.
		Battery is dry charged, shipped without acid.			
B.	R4411-36set	Battery hold down rods, pair	'36-'57		n.a.
"	R66390-58set	Battery hold down rods, pair	'58-'64		n.a.
		(rod sets include wing nuts)			
	R4407-36	Battery cover, original style	'36-'64		n.a. ☉
C.	R4407-36B	Battery cover	black	'36-'64	n.a. ☉
"	R4407-36C	Battery cover	chrome	'36-'64	12.00 ☉
D.	R4409-26P	Wing nut	5/16"-18	park	1.50 ☉
"	R4409-26	Wing nut	5/16"-18	cad	1.50 ☉
"	R66387-26	Wing nut, dimple		cad	2.38 ☉
E.	R4427-15	Mat, battery		'36-'64	3.50 ☉
F.	4433-23	Screw, terminal	cad	'36-'64	n.a.
G.	4434-23	Nut, terminal screw	cad	'36-'64	1.70 ☉
H.	4433-23A	Felt, terminal		'36-'64	1.00 ☉
	R4435-23	Complete set	cad	'36-'64	17.50 ☉

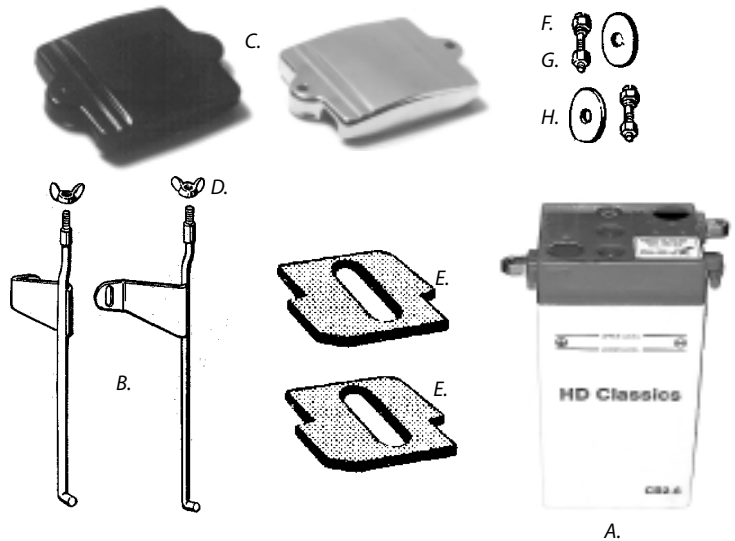

Instrument Panel

I.	R4506-47	Stud with nut	cad	'47-'67	16.25 ☉
J.	R4506-47AC	Center screw	chrome	'47-'67	9.38 ☉
K.	R2242-36B	Washer		'47-'67	0.50 ☉
L.	R4506-47B	Locktab, mounting stud		'47-'67	4.06 ☉
	C7716-2	Mounting kit	chrome	'47-'67	28.75 ☉
M.	R4512-47	Rubber, dashboard cover		'47-'67	n.a. ☉
N.	R4513-47	Bulb, panel lamp	6 Volt	'47-'64	n.a.
O.	R4518-38P	Plug, left side	park	'47-'67	n.a. ☉
"	R4518-38	Plug, left side	cad	'47-'67	n.a. ☉
P.	R4519-47	Side plate, right side	cad	'47-'67	n.a. ☉
"	R4519-47C	Side plate, right side	chrome	'47-'67	n.a. ☉
R.	R4526-47	Window	red	'47-'61	6.00
	C2713-42	Instrument panel restoration kit			30.00 ☉

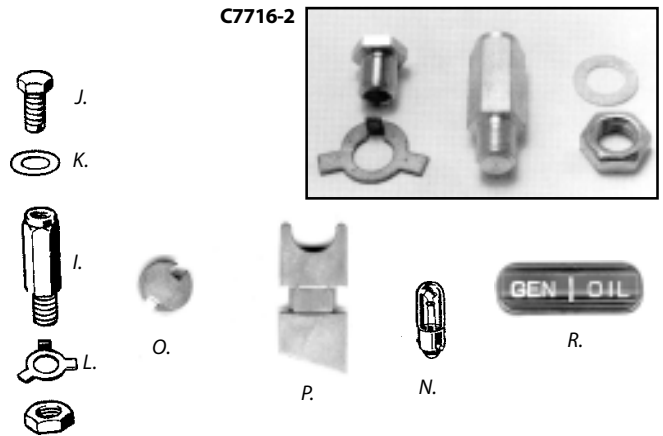

Speedometer

C. **R67215-38** Speedo knob, tripmeter 4.00
(use on some reproduction speedos)



D. **R043P** Screw, speedo mounting park 0.69 ☼
" **R043Z** Screw, speedo mounting zinc 0.30
E. **R0255P** Lockwasher park 0.25 ☼
" **R0255** Lockwasher zinc 0.20 ☼
G. **R0106P** Nut, mounting screw park 0.50 ☼
" **R0106Z** Nut, mounting screw zinc 0.30 ☼

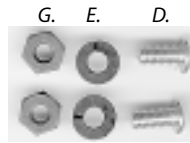

Speedometer Repair Parts

H. **R11130-48C** Bezel chrome n.a. ☼
" **R11130-48ST** Bezel stainless steel 18.00 ☼
I. **R11130-48G** Gasket foam n.a. ☼
J. **R11130-48R** Retainer unpainted '48-'52 11.50 ☼
" **R11130-53R** Retainer unpainted '53-'61 8.50 ☼
" **R11130-62R** Retainer zinc '62-up 8.50 ☼
R11129-41 Spring, reset knob '48-'61 1.30

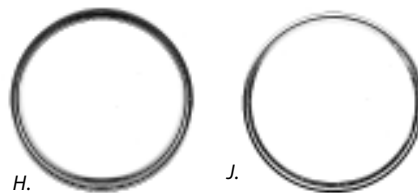

11134-36 Inner cable '36-'56 n.a.
67055-57 Inner cable '57-'61 25.00
R67055-57 Inner cable '57-'61 10.00

O. **R11136-36** Cable clamp, thick cable park '36-'51 8.12 ☼
P. **C9650-1** Cable clamp, thick cable park '52-'56 8.13 ☼
R. **C9651-1** Cable clamp, thin cable park '57-'61 8.13 ☼
S. **C9652-1** Cable clamp, thin cable zinc '61-'80 8.00 ☼

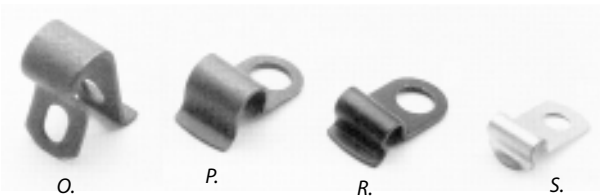

Speedo Drive

T. **R11138-36** Speedo drive unit 11T '36-'61 42.00
U. **R11140-36** Gasket, speedometer drive '36-'80 0.60
V. **R11144-36** Drive gear and shaft '36-'61 25.00

W. **R032P** Screw park 0.63 ☼
" **R032** Screw cad 0.69 ☼
" **R032C** Screw chrome 0.81 ☼
" **R032allen** Screw Allen head chrome 0.80 ☼

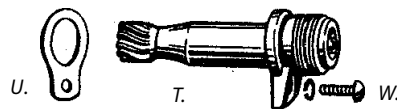

'47-'54 Taillight

A.	R5051-47	Taillight, Tombstone	black	n.a.
"	R5051-47C	Taillight, Tombstone	chrome	38.00
Above taillights include plastic lenses, 12 Volt bulb, rubber gasket and chrome license plate holder.				
C.	R027P	Door screw 8-32	park	0.63 ☉
"	R027	Door screw 8-32	cad	0.69 ☉
"	C2965-3	Set of 3 screws	stainless steel	5.00 ☉
D.	R5056-47	Gasket	foam	n.a.
E.	R5058-47	Bulb, taillight	6 Volt	2.00
"	R68165-64	Bulb, taillight	12 Volt	2.50
F.	R5059-47	Red lens	glass	n.a.
"	R5059-47P	Red lens	plastic	5.00
G.	R5061-47	Gasket, red lens	foam	n.a.
H.	R5063-47P	White lens	plastic	5.00
I.	R5065-47	Gasket, outlook lens	foam	n.a.
	C2778-4	License plate bracket screws '47-'48		5.63 ☉

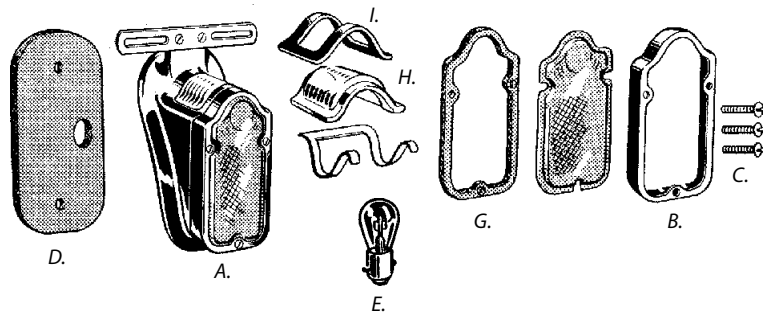

'55-'72 Taillight

J.	68086-55	Door	chrome	45.00 ☉
E.	R5058-47	Bulb, taillight	6 Volt	2.00
"	R68165-64	Bulb, taillight	12 Volt	2.50
K.	R68093-55	Outlook lens	plastic	3.50
"	R68121-55	Gasket, lens	foam	4.50 ☉
M.	R68122-55	Gasket, lens	foam	5.00 ☉
N.	R68123-55	Gasket, taillight	foam	5.00 ☉

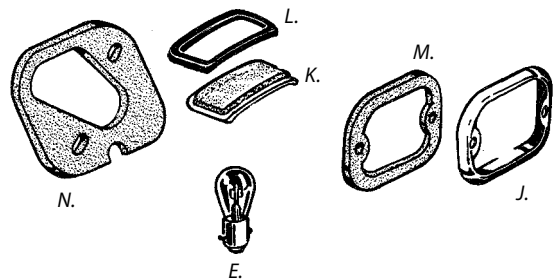

Spotlights '38-'61

O.	R11366-38C	Set of spotlights	6 Volt chrome	120.00
"	R11366-38C12V	Set of spotlights	12 Volt chrome	115.00
	R4925-206V	Replacement bulb	6 Volt	7.00
	R4925-2012V	Replacement bulb	12 Volt	7.00
	C2568-24	Spotlight rebuild kit	cad	49.38 ☉
	C3294-16	Spotlight mounting kit	park	20.00 ☉
	C3295-16	Spotlight mounting kit	cad	20.00 ☉
	C3296-16	Spotlight mounting kit	chrome	22.50 ☉

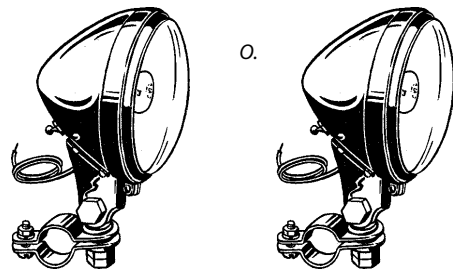

	R67710-49C	Headlamp housing, door and bracket		60.00
	C2006-3	Headlamp mounting kit (nut and washers)	'49-'59	11.88 ☉
	R67753-48	Inside lamp wiring		27.50 ☉

Horn / Wiring

	R4801-37C	Horn	6 Volt	chrome cover	42.50	(cover with wings and shield)
	R4801-37C12	Horn	12 Volt	chrome cover	42.50	(cover with wings and shield)
	R4801-37C12V	Horn	12 Volt	chrome cover	30.00	(plain cover)
(horns include custom mounting bracket)						
B.	R4884-26	Bolt, cover, with nut	cad		6.00	✳
C.	R4863-49KIT	Horn mounting kit	'49-early '51		35.00	✳
"	R4863-51KIT	Horn mounting kit	late '51-'53		35.00	✳
D.	R4855-42	Spring plate only	'49-'53		7.00	✳
	4813-31	Screw, adjusting	'31-'53		5.00	✳
	4829-31	Fibre, terminal screw	'31-'53		1.00	✳

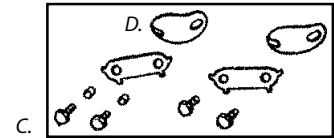
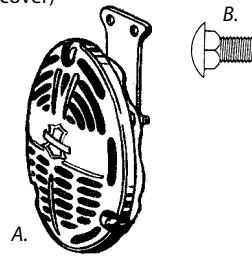

Wiring Kits

Include low tension wiring and loom.

Kits do not include turn signal wires, fender light wires or Side-car wires.

R4735-48	Wiring kit	'48 models	137.50
R4735-49	Wiring kit	'49-'57 models	135.00
R70321-58	Wiring kit	'58-'64 models	140.00
R70321-65	Wiring kit	'65-'69 models	140.00



Wire

fabric as used on '69 and earlier models

R4712-15A	black / white tracer	1 meter	2.00	✳
R4712-15B	green / white tracer	1 meter	2.00	✳
R4712-15C	yellow / black tracer	1 meter	2.00	✳
R4712-15D	red / white tracer	1 meter	2.00	✳
R4712-15E	green	1 meter	2.00	✳
R4712-15F	red	1 meter	2.00	✳
R4712-15G	black / red tracer	1 meter	2.00	✳
R4712-15H	gray / black tracer	1 meter	2.00	✳
R4712-15K	red / black tracer	1 meter	2.00	✳
R4712-15M	blue / white tracer	1 meter	2.00	✳
R4712-15P	red / yellow tracer	1 meter	2.00	✳
R4712-15R	black	1 meter	2.00	✳
R4712-15S	white / blue tracer	1 meter	2.00	✳
R4712-15T	light blue / black tracer	1 meter	2.00	✳
R4712-15T	yellow	1 meter	2.00	✳

Wire loom

fabric as used on '69 and earlier models

R4711-45A	3/16"	4,75 mm	1 meter	3.50	✳
R4711-45B	1/4"	6,35 mm	1 meter	3.50	✳
R4711-45C	5/16"	7,93 mm	1 meter	3.50	✳
R4711-45D	3/8"	9,52 mm	1 meter	4.00	✳
R4711-45E	1/2"	12,70 mm	1 meter	n.a.	



Terminals

R1520-40	Flag terminal	14-16 gauge	#10 eye size	1.00	✳
R1520-41	Ring terminal	14-16 gauge	#6 eye size	0.25	✳
R1520-42	Ring terminal	14-16 gauge	#10 eye size	0.25	✳
R1520-43	Flag terminal	14-16 gauge	#12 eye size	0.50	✳



C8005-12	Terminal box assembly	'48-'69	66.25	✳
Complete with coil mounting studs.				
4592-48	Stud, coil mounting	cad '48-'55	6.00	✳
C8823-10	Coil mounting stud kit	cad '48-'55	14.38	✳
C8824-8	Coil mounting stud kit	cad '56-'82	15.63	✳

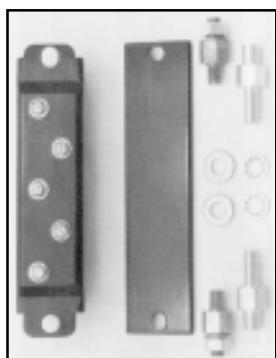

C8005-12



C8823-10

C2305-12	Terminal plate, with screws	'49-'57	40.31	✳
C2306-16	Terminal plate, with screws	'58-'69	40.31	✳

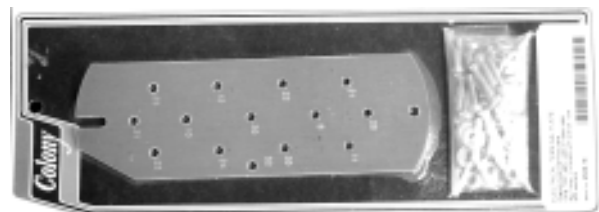

R4728-25	Clamp, wires to frame leg		15.00	✳
10002	Clamp, front wires to fork		5.00	✳
C2545-1	Clamp, wires to frame head	'48-'49	15.00	✳
C2546-1	Clamp, wires to frame head	'50-'60	15.00	✳
10012	Clamp, wires to frame head	'61-'84	16.00	✳
R10012	Clamp, wires to frame head	'61-'84	9.00	✳

Ignition Switch

A.	R4527-36C	Switch, ignition	'36-'67 chrome	34.00
B.	R4531-36C	Cover, key hole	'36-'67 chrome	n.a.
	71572-44	Contact holder (repair part)		16.00

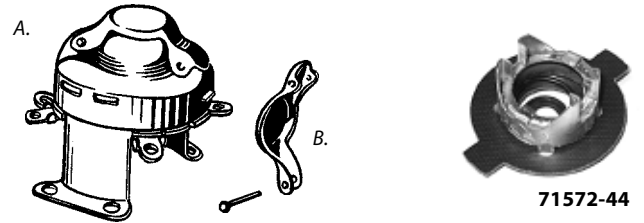

Horn Switch

D.	4762-26	Button		n.a. ☼
E.	4764-26	Spring		2.00 ☼
F.	4766-26	Insulation		5.00 ☼
G.	4776-26	Washer, horn spring		8.00 ☼
I.	R018P	Screw	park	0.56 ☼
"	R018	Screw	cad	0.63 ☼
"	R018C	Screw	chrome	0.75 ☼

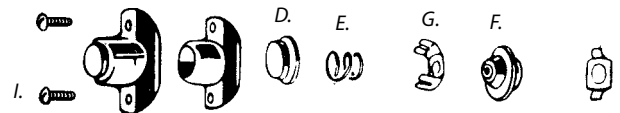

Headlight Dimmer Switch

J.	4760-29N	Switch	green	75.00 ☼
K.	4764-29	Lever		n.a. ☼
	4768-29C	Housing	chrome	n.a.
M.	4768-29N	Housing	green	14.00 ☼
N.	4770-29	Pin, contact (2 position)		4.00 ☼
"	4770-38A	Pin, contact (3 position)		5.00 ☼
O.	4771-29	Spring, pin		2.50 ☼
P.	4776-29	Block		n.a.
I.	R018P	Screw	park	0.56 ☼
"	R018	Screw	cad	0.63 ☼
"	R018C	Screw	chrome	0.75 ☼

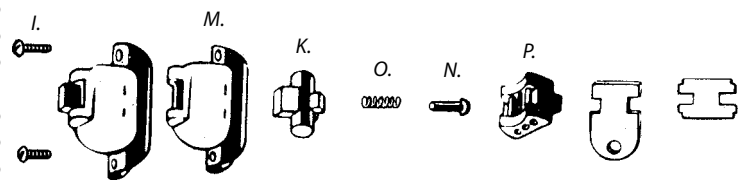

Auxiliary switches (external wiring)

	71847-65	Housing, large hole for braided loom		24.00 ☼
	4760-38AC	Two-position switch (spotlights)		n.a. ☼
	4760-50C	Three-position switch (turn signals)		n.a. ☼
	70127-70	Switch with wires (pvc), small hole		85.00 ☼

Check website for availability

	10001	Clamp, auxiliary switch	zinc	9.00 ☼
	R1602-30	Clamp, auxiliary switch wires	park	14.38 ☼



Stop Light Switch '39-'57

T.	R5081-39B	Switch, complete	black	n.a.
"	R5081-39C	Switch, complete	chrome	23.00
Complete switches include spring, wire and rod lock				
U.	R5081-39	Switch only	black	n.a.
V.	5082-39	Bracket, switch (repair)		2.00 ☼
	5083-39	Insulator, switch	paper	n.a.
	C2503-4	Mounting bolt and spacer	park	8.75 ☼
	C3621-4	Mounting bolt and spacer	chrome	11.50 ☼
W.	R2958-35P	Lock w.stud and nut	park	28.13 ☼
"	R2958-35cad	Lock w.stud and nut	cad	28.13 ☼
	R2958-35A	Stud with wing nut only	zinc	4.00 ☼
Y.	R5084-39	Spring, operating	black	3.00 ☼
"	R5084-39C	Spring, operating	chrome	n.a. ☼
Z.	R5088-39	Pull wire	park	4.50 ☼

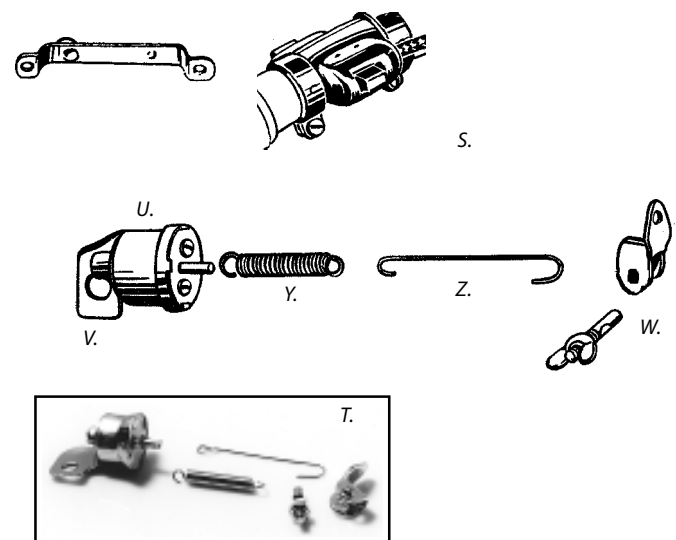

Relay '38-'57

Electronic, use with 32E three brush generator. (V-Tronic)

	R4785-38	Relay, without cover		45.00
	R4786-38DR	Cover	black	20.00
	R4786-38DRC	Cover	chrome	21.00

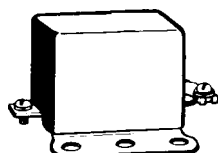

	R8375-47	Voltage regulator	6 Volt	99.00
	R8375-32	Voltage regulator	12 Volt	99.00

Special regulators designed for use with two-brush generators on '32-'57 models. Without cover. (V-Tronic)

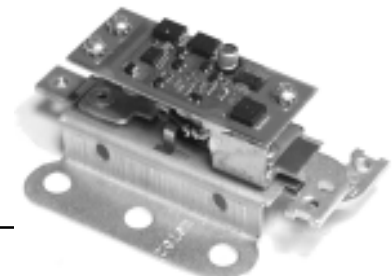

Accessories

Sidecar Parts

R6231-39	Fender trim with clips (right hand sidecars)	'39-early'67	n.a. ⚡
R3765-39	Set clips only (26)	'39-early'67	19.50 ⚡
R41836-58	Spring, brake shoe	'58-'79	4.50
R6185-41A	Brake rod park	'41-'57	32.00 ⚡
R87777-58	Brake tube, front	'58-'69	26.00 ⚡

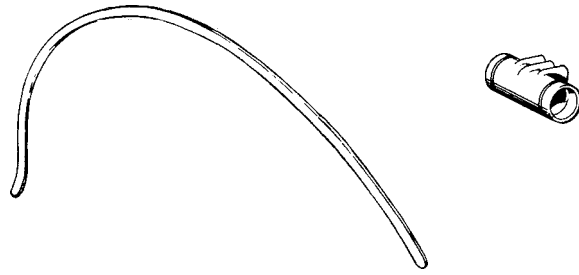

See Colony catalog for many side-car hardware items.

R11787-XC	Set of saddlebag plates chrome to mount saddlebags directly to fender, 4 hole style		n.a. ⚡
------------------	--	--	--------

C8205-8	Mounting kit, 8 studs with acorn nuts	33.75 ⚡
----------------	---------------------------------------	---------

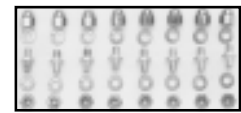
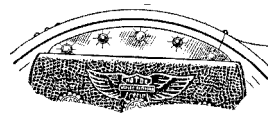

C8205-8

Windshield trim mounting kit, special phillips head screws fasten plastic to steel frame. '49-up all models, available in 2 finishes.

C9200-33	Chrome screws/chrome acorn nuts	40.00 ⚡
C9201-33	Chrome screws/cad plated acorn nuts	37.50 ⚡



C9200-33

R11350-42C	Mirror, with clamp chrome	10.00
91870-34T	Mirror, with clamp "Harley-Davidson"	65.00



R13999-X	Registration certificate holder Early accessory item made by Superior	20.00
-----------------	--	-------



Feeler Gauges



MFG002 25- Blade .0015" - .035" n.a.

U.S. Pitch Gauge

M3118PG Measures number of threads per inch n.a.
Essential tool for determining all UNF/UNC and special thread sizes.



Thread Files

To restore externally damaged threads.

MTR1 Contains most popular sizes n.a.
(11, 12, 13, 14, 16, 18, 20, 24 threads per inch)

MTR2 Contains less used sizes n.a.
(9, 10, 12, 16, 20, 27, 28, 32 threads per inch)



R1080 Solid brass hammer, 48 oz. 1-1/4" head 120.00 ☺



R1081 Solid brass punch set, 4-piece 139.50 ☺
Includes 3/8", 1/2", 5/8", 3/4" punch, use 3/8" punch for setting oil pump check valve ball.



Grease Guns

- Alemite connections are used with "Alemite" nipples ('24-'37 models).
- Hydraulic connections are for use with '38-up "Zerk" grease nipples.

GG1 Grease gun, with hydraulic connection n.a.
GG3 Grease gun, with Alemite connection n.a.

Grease gun for Alemite nipples uses flexible hose.

GG4 High pressure hose only 9.50
GG6 Alemite nipple head 47.50



C2962-6 Alemite grease nipples (6) brass '24-'37 22.50
C8770-6 Alemite grease nipples (6) Nickle '24-'37 22.50

Heli-Coil® / Taps & Dies



Heli-Coil® has the most effective and universally accepted method of thread repair. Heli-Coil® inserts quickly and permanently restore stripped, worn or damaged threads to their original size and condition.

Heli-Coil® Thread Repair Kits

Individual kits come complete with a quantity of Heli-Coil® stainless steel inserts, a tap and an installation tool, order correct size drill seperately. All kits come with step-by-step instructions.



Heli-Coil® Kits, UNF-UNC

Kit	Thread	Inserts	Length	Use drill	
H5521-2	8-32	12	.246"	11/64"	56.00
H5521-3	10-24	12	.285"	13/64"	56.00
H5528-3	10-32	12	.285"	13/64"	65.00
H5521-1	12-24	12	.324"	15/64"	57.00
H5521-4	1/4"-20	12	.375"	17/64"	43.00
H5528-4	1/4"-28	12	.375"	17/64"	65.00
H5521-5	5/16"-18	12	.469"	21/64"	41.00
H5528-5	5/16"-24	12	.469"	21/64"	65.00
H5521-6	3/8"-16	12	.562"	25/64"	44.00
H5528-6	3/8"-24	12	.562"	25/64"	65.00
H5521-7	7/16"-14	6	.656"	29/64"	44.00
H5528-7	7/16"-20	6	.656"	26/64"	65.00

Inserts only, UNF-UNC

Set	Thread	Inserts	Length	
HR1185-2	8-32	12	.246"	20.00
HR1185-3	10-24	12	.285"	21.00
HR1191-3	10-32	12	.285"	21.00
HR1185-1	12-24	12	.324"	21.00
HR1185-4	1/4"-20	12	.375"	21.00
HR1191-4	1/4"-28	12	.375"	21.00
HR1185-5	5/16"-18	12	.469"	21.00
HR1191-5	5/16"-24	12	.469"	21.00
HR1185-6	3/8"-16	12	.562"	26.00
HR1191-6	3/8"-24	12	.562"	26.00
HR1185-7	7/16"-14	6	.656"	20.00
HR1191-7	7/16"-20	6	.656"	20.00

Heli-Coil® Kits, Special

Kit	Thread	Inserts	Length	Use drill	
H5540-4	1/4"-24	12	.500"	17/64"	125.00
Gear cover screws, tappet guide screws, oil pump, etc.					
H5540-6	3/8"-20	6	.375"	25/64"	83.00
Brake drum wheel bolts 1936-1972.					
H5540-7	7/16"-16	6	.656"	29/64"	n.a.
Headbolts 1930-1973 Flatheads, 1936-1947 Knucklehead.					
H5521-8-2	1/2"-13	6	.375"	17/32"	75.00
Early Sportster engine and transmission.					
H5528-8-2	1/2"-20	6	.375"	33/64"	77.00
Primary plug, Sportster transmission.					
H5528-10-2	5/8"-18	6	.325"	41/64"	n.a.
Timing hole plug '31-up.					
H5523-14	M14-1.25	30	3/8"		165.00
Spark plugs 1948-1974 Panhead, Shovelhead, Sportster.					
H5523-18	M18-1.50	24	.500"		n.a.
Spark plugs 1930-1973 Flatheads, 1936-1947 Knucklehead.					
H5407-2	1/8"-27 NPT				170.00

Inserts only, Special

Set	Thread	Inserts	Length	
HR389-4	1/4"-24	12	.500"	25.00
HR389-6	3/8"-20	6	.375"	16.00
HR389-7-2	7/16"-16	6	.656"	24.00
HR1185-8-2	1/2"-13	6	.375"	21.00
HR1191-8-2	1/2"-20	6	.375"	24.00
HR1191-10-2	5/8"-18	6	.325"	38.00
HR512	M14-1.25	6	3/8"	17.50
HR514-6	M18-1.50	6	.500"	24.00
HR327-2	1/8"-27 NPT	12		30.00

Taps and Dies, Special Sizes

tap160-001	7/32"-32	tap	n.a.	Tank top filler strip 750cc '37-'73, tank mounting, all models '18-'35.
M1421T	1/4"-24	tap	7.00	This thread size has many applications on the older Harley's, including gear cover screws, tappet guide screws, oil pump nuts, etc.
die160-005	1/4"-24	die	n.a.	Linkert carburetor float lever pin (1196-11 and 1197-16) and bowl drain screw (1269-39), also oversize tank top screw.
tap160-003	1/4"-32	tap	n.a.	
tap160-002	1/4"-40	tap	n.a.	Linkert carburetor low and high speed needle. (in housing and in lever 1292-27)
tap160-011	9/32"-32	tap	n.a.	Bendix carburetors.
tap160-809	5/16"-32	tap	n.a.	Grease nipples, 1924 and later.
tap160-807	3/8"-20	tap	10.00	Wheel bolts 1936-1972.
die160-007	3/8"-20	die	n.a.	
tap160-416	7/16"-16	tap	n.a.	Head bolts, all Flatheads with headbolts 1930-1973, all Knuckleheads 1936-1947.
die160-006	7/16"-16	die	n.a.	
tap160-012	7/16"-24	tap	n.a.	Oversize cylinder head studs 750cc.
tap160-010	7/16"-28	tap	n.a.	750cc models '41-'73 clutch lever.
C9407-1	11/16"-16	tap	45.00	Oversize timing hole plug
tap160-004	3/4"-18	tap	n.a.	1940-1965 petrol valve nipple in tank.
die160-008	3/4"-20	die	n.a.	Linkert carburetor bowl lock nut (1268-29)
tap160-904	13/16"-24	tap	n.a.	Handlebar end screw 750cc models '31-'39, all models '31-'35.
tap160-905	7/8"-24	tap	n.a.	Handlebar end screw (3330-36), 1936-1948.
die160-009	7/8"-24	die	n.a.	Fork stem 750cc models.



Taps, high carbon steel, UNF/UNC

M1111T	4-36	4.50	M1427T	5/16"-18	5.75
M1112T	4-40	4.50	M1429T	5/16"-24	5.75
M1118T	6-32	4.50	M1434T	3/8"-16	6.00
M1124T	8-32	4.50	M1436T	3/8"-24	6.00
M1128T	10-24	4.50	M1439T	7/16"-14	7.00
M1131T	10-32	4.50	M1440T	7/16"-20	7.00
M1132T	12-24	4.50	M1444T	1/2"-13	8.00
M1135T	14-20	4.50	M1445T	1/2"-20	8.00
M1412T	3/16"-24	4.50	M1448T	9/16"-12	11.00
M1420T	1/4"-20	4.50	M1449T	9/16"-18	11.00
M1423T	1/4"-28	4.50			

Please Check Website For Availability



Dies, high carbon steel, UNF/UNC

M6112DI	4-40	8.00	M6527DI	5/16"-18	8.00
M6118DI	6-32	8.00	M6529DI	5/16"-24	8.00
M6124DI	8-32	8.00	M6534DI	3/8"-16	8.00
M6128DI	10-24	8.00	M6536DI	3/8"-24	8.00
M6131DI	10-32	8.00	M6539DI	7/16"-14	8.00
M6132DI	12-24	8.00	M6540DI	7/16"-20	8.00
M6520DI	1/4"-20	8.00	M6544DI	1/2"-13	8.00
M6523DI	1/4"-28	8.00	M6545DI	1/2"-20	8.00



Drills

General purpose drills made of fine quality high speed steel.
Hardened and tempered with extreme accuracy to retain sharpness and long life.



Fractional Sizes

M6104D	1/16"	2.00	M6112D	3/16"	3.50	M6120D	5/16"	7.00	M6128D	7/16"	12.00
M6105D	5/64"	2.00	M6113D	13/64"	3.50	M6121D	21/64"	9.00	M6129D	29/64"	15.00
M6106D	3/32"	2.00	M6114D	7/32"	3.50	M6122D	11/32"	9.00	M6130D	15/32"	15.00
M6107D	7/64"	2.00	M6115D	15/64"	5.00	M6123D	23/64"	8.75	M6131D	31/64"	17.00
M6108D	1/8"	3.00	M6116D	1/4"	5.00	M6124D	3/8"	9.50	M6132D	1/2"	17.00
M6109D	9/64"	3.00	M6117D	17/64"	5.00	M6125D	25/64"	9.50	M9134D	17/32"	32.50
M6110D	5/32"	3.00	M6118D	9/32"	5.00	M6126D	13/32"	9.50		(1/2" shank)	
M6111D	11/64"	3.00	M6119D	19/64"	7.00	M6127D	27/64"	12.00			

Letter Sizes

M4101D	A	.234"	4.00	M4108D	H	.266	5.00	M4115D	O	.316	6.75	M4122D	V	.377	9.75
M4102D	B	.238	4.00	M4109D	I	.272	5.00	M4116D	P	.323	8.00	M4123D	W	.386	9.75
M4103D	C	.242	4.00	M4110D	J	.277	5.75	M4117D	Q	.332	8.00	M4124D	X	.397	11.50
M4104D	D	.246	4.00	M4111D	K	.281	5.75	M4118D	R	.339	8.00	M4125D	Y	.404	12.50
M4105D	E	.250	4.00	M4112D	L	.290	5.75	M4119D	S	.348	9.75	M4126D	Z	.413	14.50
M4106D	F	.257	5.00	M4113D	M	.295	6.75	M4120D	T	.358	9.75				
M4107D	G	.261	5.00	M4114D	N	.302	6.75	M4121D	U	.368	9.75				

Number Sizes

M8101D	1	.228	4.00	M8121D	21	.159	2.50	M8141D	41	.096	2.00	M8161D	61	.039	2.30
M8102D	2	.221	4.00	M8122D	22	.157	2.50	M8142D	42	.093	2.00	M8162D	62	.038	2.30
M8103D	3	.213	4.00	M8123D	23	.154	2.50	M8143D	43	.089	2.00	M8163D	63	.037	2.30
M8104D	4	.209	4.00	M8124D	24	.152	2.50	M8144D	44	.086	2.00	M8164D	64	.036	2.30
M8105D	5	.205	4.00	M8125D	25	.149	2.50	M8145D	45	.082	2.00	M8165D	65	.035	2.30
M8106D	6	.204	4.00	M8126D	26	.147	2.50	M8146D	46	.081	2.00	M8166D	66	.033	2.30
M8107D	7	.201	4.00	M8127D	27	.144	2.50	M8147D	47	.078	2.00	M8167D	67	.032	2.30
M8108D	8	.199	4.00	M8128D	28	.140	2.50	M8148D	48	.076	2.00	M8168D	68	.031	2.30
M8109D	9	.196	4.00	M8129D	29	.136	2.50	M8149D	49	.073	2.00	M8169D	69	.0292	2.30
M8110D	10	.193	4.00	M8130D	30	.128	2.50	M8150D	50	.070	2.00	M8170D	70	.028	2.30
M8111D	11	.191	4.00	M8131D	31	.120	2.00	M8151D	51	.067	2.00	M8171D	71	.026	2.30
M8112D	12	.189	3.50	M8132D	32	.116	2.00	M8152D	52	.063	2.00	M8172D	72	.025	2.30
M8113D	13	.185	3.50	M8133D	33	.113	2.00	M8153D	53	.059	2.00	M8173D	73	.025	2.30
M8114D	14	.182	3.50	M8134D	34	.111	2.00	M8154D	54	.055	2.00	M8174D	74	.0225	2.30
M8115D	15	.180	3.50	M8135D	35	.110	2.00	M8155D	55	.052	2.00	M8175D	75	.021	2.70
M8116D	16	.177	3.50	M8136D	36	.106	2.00	M8156D	56	.046	2.30	M8176D	76	.020	2.70
M8117D	17	.173	3.50	M8137D	37	.104	2.00	M8157D	57	.043	2.30	M8177D	77	.018	2.70
M8118D	18	.169	2.50	M8138D	38	.101	2.00	M8158D	58	.042	2.30	M8178D	78	.016	2.70
M8119D	19	.166	2.50	M8139D	39	.099	2.00	M8159D	59	.041	2.30	M8179D	79	.0145	2.70
M8120D	20	.161	2.50	M8140D	40	.098	2.00	M8160D	60	.040	2.30	M8180D	80	.0135	2.70

Screws, Bolts, Nuts

Round Head Screws

Listed by size.



R016P	6-32 x 3/8"	park	0.63
R016Z	6-32 x 3/8"	zinc	0.30
R013Z	6-32 x 7/8"	zinc	0.30
R018P	8-32 x 1/4"	park	0.56
R018	8-32 x 1/4"	cad	0.63
R018C	8-32 x 1/4"	chrome	0.75
4940-35	8-32 x 1/4"	zinc	1.50
R019P	8-32 x 5/16"	park	0.56
R019	8-32 x 5/16"	cad	0.63
R027P	8-32 x 5/8"	park	0.63
R027	8-32 x 5/8"	cad	0.69
R026Z	8-32 x 1"	zinc	0.50
R030	10-24 x 3/8"	cad	0.69
R030P	10-24 x 3/8"	park	0.63
R030Z	10-24 x 3/8"	zinc	0.30
R030C	10-24 x 3/8"	chrome	0.75
R031P	10-24 x 1/2"	park	0.63
R031Z	10-24 x 1/2"	zinc	0.30
R031C	10-24 x 1/2"	chrome	0.60
R034	10-32 x 1/4"	cad	0.50
R034P	10-32 x 1/4"	park	0.63
R034Z	10-32 x 1/4"	zinc	0.30
R034C	10-32 x 1/4"	chrome	0.60
4941-35	10-32 x 1/4"	zinc	1.00
R041P	12-24 x 3/8"	park	0.75
R041Z	12-24 x 3/8"	zinc	0.30
R043P	12-24 x 1/2"	park	0.60
R043Z	12-24 x 1/2"	zinc	0.30
R4918-35P	12-24 x 3/4"	park	1.00
R4918-35	12-24 x 3/4"	cad	1.06
R4918-35C	12-24 x 3/4"	chrome	1.50
050	1/4-24 x 7/16"	park	2.00
R050P	1/4-24 x 7/16"	park	1.38
R050	1/4-24 x 7/16"	cad	1.44
R050C	1/4-24 x 7/16"	chrome	1.63
R050NI	1/4-24 x 7/16"	Nickle	n.a.
R051P	1/4-24 x 1/2"	park	1.44
R051	1/4-24 x 1/2"	cad	1.50
R051C	1/4-24 x 1/2"	chrome	2.63
052	1/4-24 x 5/8"	park	2.00
R052P	1/4-24 x 5/8"	park	1.50
R052	1/4-24 x 5/8"	cad	1.56
R052C	1/4-24 x 5/8"	chrome	2.19
053	1/4-24 x 3/4"	park	3.00
R053	1/4-24 x 3/4"	cad	1.63
R053P	1/4-24 x 3/4"	park	1.56
053Z	1/4-24 x 3/4"	zinc	n.a.
R053C	1/4-24 x 3/4"	chrome	1.80
R053NI	1/4-24 x 3/4"	Nickle	n.a.

Fillister Head Screws

Listed by size.



R010P	6-32 x 1/4"	zinc	0.44
R010Z	6-32 x 1/4"	zinc	0.30
R011P	6-32 x 3/8"	park	0.56
R011Z	6-32 x 3/8"	zinc	n.a.
R011C	6-32 x 3/8"	chrome	0.60
R020	8-32 x 1/4"	cad	0.63
R020P	8-32 x 1/4"	park	0.56
R020Z	8-32 x 1/4"	zinc	0.30
R020C	8-32 x 1/4"	chrome	0.60
R021P	8-32 x 3/8"	park	0.63
R021	8-32 x 3/8"	cad	0.63
R021Z	8-32 x 3/8"	zinc	0.30
R021C	8-32 x 3/8"	chrome	0.60
R021NI	8-32 x 3/8"	Nickle	0.88
4918-42	8-32 x 3/8"	green	0.40
R024P	8-32 x 3/4"	park	0.63
R024Z	8-32 x 3/4"	zinc	n.a.
R024C	8-32 x 3/4"	chrome	n.a.
R026P	8-32 x 1"	park	0.75
R030AP	10-24 x 3/8"	park	0.75
R030A	10-24 x 3/8"	cad	0.75
R030AZ	10-24 x 3/8"	zinc	0.30
R032P	10-24 x 1/2"	park	0.63
R032	10-24 x 1/2"	cad	0.69
R032C	10-24 x 1/2"	chrome	0.81
R033P	10-24 x 5/8"	park	0.63
R033	10-24 x 5/8"	cad	0.69
R033Z	10-24 x 5/8"	zinc	0.30
R033C	10-24 x 5/8"	chrome	0.85
R033LP	10-24 x 3/4"	park	0.75
R033L	10-24 x 3/4"	cad	0.75
R033LC	10-24 x 3/4"	chrome	0.90
R033XL	10-24 x 1"	cad	0.75
R033XLC	10-24 x 1"	chrome	0.90
R035P	10-32 x 3/8"	park	0.63
R035	10-32 x 3/8"	cad	0.69
R035C	10-32 x 3/8"	chrome	0.81
R035NI	10-32 x 3/8"	Nickle	0.65
R036P	10-32 x 1/2"	park	0.63
R036	10-32 x 1/2"	cad	0.69
R036C	10-32 x 1/2"	chrome	0.81
R036NI	10-32 x 1/2"	Nickle	n.a.
R037P	10-32 x 5/8"	park	0.63
R037	10-32 x 5/8"	cad	0.69
R037C	10-32 x 5/8"	chrome	1.13
R037NI	10-32 x 5/8"	Nickle	0.90
R038P	10-32 x 3/4"	park	0.63
R038Z	10-32 x 3/4"	zinc	0.50
R038C	10-32 x 3/4"	chrome	n.a.
R038AP	10-32 x 7/8"	park	0.63
R038A	10-32 x 7/8"	cad	0.50
R1523-26	10-32 x 1-1/4"	zinc	1.50
R042P	12-24 x 1/2"	park	0.63
R042	12-24 x 1/2"	cad	0.69
R042C	12-24 x 1/2"	chrome	0.88
R042NI	12-24 x 1/2"	Nickle	n.a.
4967-42MD	12-24 x 1/2" special		1.50
R044Z	12-24 x 7/8"	zinc	0.50
R044C	12-24 x 7/8"	chrome	n.a.

Oval Countersunk Head Screws

Listed by size.



2265W	12-24 x 3/8"	zinc	1.00
R048C	12-24 x 3/8"	chrome	0.80
R048AP	12-24 x 1/2"	park	0.94
R048A	12-24 x 1/2"	cad	1.00
R048AC	12-24 x 1/2"	chrome	1.25
R045	12-24 x 21/32"	cad	1.38
047	12-24 x 13/16"	park	2.00
R047P	12-24 x 13/16"	park	1.38
047cad	12-24 x 13/16"	cad	2.00
R047	12-24 x 13/16"	cad	1.44
R047C	12-24 x 13/16"	chrome	1.69
R1409-41MP	12-24 x 2-1/4"	park	4.06
R1409-41M	12-24 x 2-1/4"	cad	4.06
R057P	1/4-24 x 13/16"	park	1.56
R057	1/4-24 x 13/16"	cad	1.56
R057C	1/4-24 x 13/16"	chrome	2.19
R057NI	1/4-24 x 13/16"	Nickle	1.75
R2268-36P	1/4-24 x 13/16"	park	1.25
R2268-36	1/4-24 x 13/16"	cad	1.44
R2268-36C	1/4-24 x 13/16"	chrome	1.88
056	1/4-24 x 1-1/8"	park	1.95
R056P	1/4-24 x 1-1/8"	park	1.88
R056	1/4-24 x 1-1/8"	cad	1.88
R056C	1/4-24 x 1-1/8"	chrome	2.31
R056NI	1/4-24 x 1-1/8"	Nickle	n.a.
2341HW	1/4-24 x 1-1/8"	zinc	2.00
R1523-32P	1/4-24 x 2"	park	3.75
R1523-32	1/4-24 x 2"	cad	3.75
R1523-32C	1/4-24 x 2"	chrome	5.00
R1523-36P	1/4-24 x 3"	park	4.06
R1523-36	1/4-24 x 3"	cad	4.06
R1523-36C	1/4-24 x 3"	chrome	5.63
058	5/16-18 x 13/16"	bare	3.00
R3805-30AP	5/16-24 x 19/32"	park	5.00
R3805-30A	5/16-24 x 19/32"	cad	5.00
R3749-30P	5/16-24 x 27/32"	park	6.00
R3749-30	5/16-24 x 27/32"	cad	6.00
R3749-30C	5/16-24 x 27/32"	chrome	7.00



Hex Head Bolts



Listed by size:

R4518-36	10-32 x 5/16"		cad	2.25
R4518-36C	10-32 x 5/16"		chrome	3.00
R1409-36P	12-24 x 3/8"		park	2.50
R1409-36	12-24 x 3/8"		cad	2.50
R054Z	1/4-20 x 1"	'grade'	zinc	0.40
R054C	1/4-20 x 1"		chrome	1.30
R692-41P	1/4-20 x 1-1/4"		park	1.88
R692-41	1/4-20 x 1-1/4"	'grade'	cad	1.88
R692-41C	1/4-20 x 1-1/4"		chrome	2.50
054A	1/4-24 x 1/2"		zinc	4.00
1123-29	1/4-24 x 5/8"		park	1.50
R1123-29	1/4-24 x 5/8"		cad	3.13
R1123-29C	1/4-24 x 5/8"		chrome	4.06
053E	1/4-24 x 3/4"		park	3.00
R053EP	1/4-24 x 3/4"		park	2.50
7223-34	1/4-24 x 3/4"	'1035 cp'	park	n.a.
R7223-34	1/4-24 x 3/4"		cad	2.50
R7223-34C	1/4-24 x 3/4"		chrome	3.75
R13332-25AP	1/4-24 x 1-5/8"		park	3.13
13332-25Acad	1/4-24 x 1-5/8"	'rockford'	cad	3.20
R13332-25A	1/4-24 x 1-5/8"		cad	3.13
R13332-25AC	1/4-24 x 1-5/8"		chrome	4.06
R1725-30P	1/4-28 x 7/16"		park	1.88
R054WZ	1/4-28 x 5/8"		zinc	0.50
R054WC	1/4-28 x 5/8"		chrome	1.30
R4017P	5/16-18 x 1"	'1038 cp'	park	3.50
443-37P	5/16-18 x 2-3/4"		park	n.a.
443-37	5/16-18 x 2-3/4"	'1035 cp'	cad	3.00
061	5/16-24 x 1/2"	'1035 cp'	park	2.50
R061P	5/16-24 x 1/2"	'1038 cp'	park	1.63
R061Z	5/16-24 x 1/2"	'grade'	zinc	0.35
R061	5/16-24 x 1/2"	'1038 cp'	cad	1.69
R061C	5/16-24 x 1/2"		chrome	1.40
060	5/16-24 x 9/16"		park	3.00
R064PS	5/16-24 x 3/4"		park	1.81
R064P	5/16-24 x 3/4"	'1038 cp'	park	1.81
R064Z	5/16-24 x 3/4"	'grade'	zinc	0.60
R064	5/16-24 x 3/4"	'1038 cp'	cad	1.88
R064C	5/16-24 x 3/4"		chrome	2.13
R064EP	5/16-24 x 7/8"	'1038 cp'	park	2.19
R066PS	5/16-24 x 1"	'1038 cp'	park	2.19
R066P	5/16-24 x 1"	'1038 cp'	park	2.19
R066Z	5/16-24 x 1"	'grade'	zinc	0.75
R066C	5/16-24 x 1"		chrome	1.30
R066AP	5/16-24 x 1-1/8"	'1038 cp'	park	2.31
R066A	5/16-24 x 1-1/8"	'1038 cp'	cad	2.31
R3748-26P	5/16-24 x 1-1/8"	'1038 cp'	park	2.50
R3748-26	5/16-24 x 1-1/8"	'grade'	cad	2.50
R3748-26C	5/16-24 x 1-1/8"		chrome	2.50
R066BP	5/16-24 x 1-3/8"	'1038 cp'	park	2.50
069	5/16-24 x 1-3/8"	dome head	park	1.50
R068PS	5/16-24 x 1-13/16"		park	2.63
R068P	5/16-24 x 1-13/16"	'1038 cp'	park	2.63
R068	5/16-24 x 1-13/16"	'1038 cp'	cad	2.81
R068C	5/16-24 x 1-13/16"		chrome	1.50
R3529-37PS	5/16-24 x 2-1/4"		park	3.13
R3529-37P	5/16-24 x 2-1/4"	'1038 cp'	park	3.13
R3529-37	5/16-24 x 2-1/4"	'1038 cp'	cad	3.25
R3529-37C	5/16-24 x 2-1/4"		chrome	3.75

About hex head markings:

'41 and earlier bolts were usually made by Harley and were not marked (plain head). War-time production saw the arrival of other suppliers, these could be marked "1035 cp" or "1038 cp".



'1035 cp'



'1038 cp'



'grade'

Hex Head Bolts (continued)

R3529-36PS	5/16-24 x 2-5/8"		park	3.44
R3529-36P	5/16-24 x 2-5/8"	'1038 cp'	park	3.44
R3529-36C	5/16-24 x 2-5/8"		chrome	3.75
R070P	3/8-16 x 3/4"	'1035 cp'	park	3.38
R070Z	3/8-16 x 3/4"	'grade'	zinc	0.50
R070	3/8-16 x 3/4"	'1035 cp'	cad	3.44
R070C	3/8-16 x 3/4"		chrome	1.40
R072Z	3/8-16 x 7/8"	'grade'	zinc	0.50
R2263-36BP	3/8-16 x 1"		park	2.19
R2263-36B	3/8-16 x 1"	'grade'	cad	1.85
R2263-36BC	3/8-16 x 1"		chrome	2.25
071	3/8-16 x 1-3/16"		park	4.00
R071P	3/8-16 x 1-3/16"		park	3.75
R071	3/8-16 x 1-3/16"		cad	3.75
R071C	3/8-16 x 1-3/16"		chrome	4.69
073	3/8-16 x 1-3/8"		park	5.00
R073P	3/8-16 x 1-3/8"		park	3.75
R073	3/8-16 x 1-3/8"		cad	3.75
R073C	3/8-16 x 1-3/8"		chrome	4.69
R444-30P	3/8-16 x 3-1/4"		park	4.38
R444-30	3/8-16 x 3-1/4"		cad	4.38
R444-30C	3/8-16 x 3-1/4"		chrome	5.31
R074P	3/8-24 x 3/4"		park	2.50
R074Z	3/8-24 x 3/4"	'grade'	zinc	0.50
R074C	3/8-24 x 3/4"		chrome	1.40
R074NI	3/8-24 x 3/4"		Nickle	n.a.
2823-26	3/8-24 x 7/8"		park	7.00
R2823-26P	3/8-24 x 7/8"		park	5.00
R2823-26	3/8-24 x 7/8"		cad	5.00
R2823-26C	3/8-24 x 7/8"		chrome	6.75
4336W	3/8-24 x 1-1/8"	'grade'	zinc	2.50
2100-16	3/8-24 x 1-1/8"	dome head	park	8.00
R2100-16C	3/8-24 x 1-1/8"	dome head	chrome	9.38
R079P	3/8-24 x 1-1/8"		park	4.06
R079	3/8-24 x 1-1/8"		cad	4.19
R079C	3/8-24 x 1-1/8"		chrome	4.81
R078C	3/8-24 x 1-1/4"		chrome	1.50
R075	3/8-24 x 1-3/8"		cad	5.63
R075C	3/8-24 x 1-3/8"		chrome	6.25
R075P	3/8-24 x 1-3/8"		park	5.63
R437-26P	3/8-24 x 1-3/4"	'1035 cp'	park	6.25
R437-26	3/8-24 x 1-3/4"	'1035 cp'	cad	6.25
R437-26C	3/8-24 x 1-3/4"		chrome	7.50
R437-36P	3/8-24 x 2-5/8"		park	6.25
R437-36	3/8-24 x 2-5/8"	'1038 cp'	cad	6.25
R437-36C	3/8-24 x 2-5/8"		chrome	7.50
R438-36P	3/8-24 x 3-5/16"	'1038 cp'	park	7.50
R438-36	3/8-24 x 3-5/16"	'1038 cp'	cad	7.50
R438-36C	3/8-24 x 3-5/16"		chrome	8.75
2807-30	7/16-20 x 1"		park	5.00
2807-3035	7/16-20 x 1"	'1035 cp'	park	8.00
R080P	7/16-20 x 1-1/2"		park	6.25
R080Z	7/16-20 x 1-1/2"	'grade'	zinc	0.70
R080C	7/16-20 x 1-1/2"		chrome	1.70
R6033-30P	7/16-20 x 1-5/16"	'1035 cp'	park	5.13
R6033-30	7/16-20 x 1-5/16"	'1035 cp'	cad	5.13
R6033-30C	7/16-20 x 1-5/16"		chrome	6.88
14-30	7/16-20 x 1-3/4"		park	10.00

Screws, Bolts, Nuts

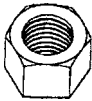

About nuts:

Early 1940's and earlier nuts were mostly manufactured by H-D and were machined from stock. These nuts are clearly different than the later style nuts. We have marked all the nuts on this page with a 'm' to indicate that they are machined.

'machined'
(sharp edges)



not 'machined'
(round edges)

Nuts

Listed by size:

R0101P	6-32 x 7/64" x 5/16"	park	0.50
R0101B	6-32 x 7/64" x 5/16"	brass	0.50
R0101Z	6-32 x 7/64" x 5/16"	zinc	0.40
R0103P	8-32 x 1/8" x 11/32"	park	0.50
R0103	8-32 x 1/8" x 11/32"	cad	0.50
R0103Z	8-32 x 1/8" x 11/32"	zinc	0.40
R0104P	10-24 x 1/8" x 3/8"	park	0.50
R0104	10-24 x 1/8" x 3/8"	cad	0.50
R0104Z	10-24 x 1/8" x 3/8"	zinc	0.40
R0104C	10-24 x 1/8" x 3/8"	chrome	0.75
R0104FP	10-24 x 3/8" flexlock	park	1.06
R0104F	10-24 x 3/8" flexlock	cad	1.06
R0104FNI	10-24 x 3/8" flexlock	Nickle	1.35
4434-23	10-24 x 1/4" x 3/8"	'm' cad	1.70
0105cop	10-32 x 1/8" x 5/16"	brass	0.70
0105copm	10-32 x 1/8" x 5/16"	'm' brass	1.30
0105cad	10-32 x 1/8" x 5/16"	cad	1.00
R0105Z	10-32 x 1/8" x 5/16"	zinc	0.30
R0105C	10-32 x 1/8" x 5/16"	chrome	0.50
R0105AP	10-32 x 1/8" x 3/8"	park	0.50
R0105AZ	10-32 x 1/8" x 3/8"	zinc	0.50
R0105AC	10-32 x 1/8" x 3/8"	chrome	n.a.
R0106P	12-24 x 5/32" x 7/16"	park	0.50
R0106	12-24 x 5/32" x 7/16"	cad	0.50
R0106Z	12-24 x 5/32" x 7/16"	zinc	0.30
R0107C	1/4-20 x 1/4" x 7/16"	chrome	1.13
R0107P	1/4-20 x 1/4" x 1/2"	'm' park	1.13
R0107	1/4-20 x 1/4" x 1/2"	'm' cad	1.19
0108	1/4-24 x 5/32" x 7/16"	'm' park	1.50
R0108P	1/4-24 x 5/32" x 7/16"	'm' park	1.13
R0108M	1/4-24 x 5/32" x 7/16"	'm' cad	1.19
R0108C	1/4-24 x 5/32" x 7/16"	chrome	0.88
R0108NI	1/4-24 x 5/32" x 7/16"	'm' Nickle	1.56
0109	1/4-24 x 7/32" x 7/16"	'm' park	2.00
0109C	1/4-24 x 7/32" x 7/16"	'm' chrome	2.30
451-37	1/4-24 x 1/4" x 1/2"	park	2.00
R451-37P	1/4-24 x 1/4" x 1/2"	'm' park	1.13
R451-37	1/4-24 x 1/4" x 1/2"	'm' cad	1.13
R451-37C	1/4-24 x 1/4" x 1/2"	'm' chrome	1.56
R0111P	5/16-18 x 17/64" x 1/2"	'm' park	1.13
R0111Z	5/16-18 x 17/64" x 1/2"	zinc	0.30
R0111	5/16-18 x 17/64" x 1/2"	'm' cad	1.19
R0111C	5/16-18 x 17/64" x 1/2"	chrome	1.00
R0111NI	5/16-18 x 17/64" x 1/2"	Nickle	1.00
R0112P	5/16-24 x 17/64" x 7/16"	'm' park	1.25
R0112	5/16-24 x 17/64" x 7/16"	'm' cad	1.38
R0112NI	5/16-24 x 17/64" x 7/16"	'm' Nickle	1.50
R0117BP	5/16-24 x 3/16" x 1/2"	park	1.25
R0117B	5/16-24 x 3/16" x 1/2"	cad	1.38
R0117BC	5/16-24 x 3/16" x 1/2"	chrome	1.50
R0117P	5/16-24 x 17/64" x 1/2"	'm' park	1.19
R0117Z	5/16-24 x 17/64" x 1/2"	zinc	0.30
R0117M	5/16-24 x 17/64" x 1/2"	'm' cad	1.25
R0117C	5/16-24 x 17/64" x 1/2"	chrome	0.94
R0117NI	5/16-24 x 17/64" x 1/2"	Nickle	1.35
R7725	5/16-24 x 1/2" flexloc	cad	1.88
R7725C	5/16-24 x 1/2" flexloc	chrome	1.94
R0117A	5/16-24 x 5/16" x 9/16"	'm' park	1.44
R0120P	3/8-16 x 5/16" x 9/16"	'm' park	1.44
R0120	3/8-16 x 5/16" x 9/16"	'm' cad	1.50
R0120C	3/8-16 x 5/16" x 9/16"	'm' chrome	1.69
R0120NI	3/8-16 x 5/16" x 9/16"	'm' Nickle	1.75
R0129AP	3/8-24 x 7/32" x 9/16"	park	1.25
R0129A	3/8-24 x 7/32" x 9/16"	cad	1.25
R0129AC	3/8-24 x 7/32" x 9/16"	chrome	1.69
R0129C	3/8-24 x 7/32" x 9/16"	chrome	1.75

Nuts (continued)

0129	3/8-24 x 1/4" x 9/16"	'm' park	1.50
0129.50pack	Bag of 50 nuts	'm' park	45.00
R0129P	3/8-24 x 1/4" x 9/16"	'm' park	1.44
R0129	3/8-24 x 1/4" x 9/16"	'm' cad	1.56
0129C	3/8-24 x 1/4" x 9/16"	'm' chrome	2.50
0129Z	3/8-24 x 1/4" x 9/16"	'm' zinc	2.00
R0127P	3/8-24 x 21/64" x 9/16"	'm' park	1.50
R0127Z	3/8-24 x 21/64" x 9/16"	zinc	0.50
R0127	3/8-24 x 21/64" x 9/16"	'm' cad	1.63
R0127C	3/8-24 x 21/64" x 9/16"	chrome	1.06
R0127NI	3/8-24 x 21/64" x 9/16"	'm' Nickle	1.60
R0123P	3/8-24 x 1/2" x 9/16"	'm' park	1.50
R0123	3/8-24 x 1/2" x 9/16"	'm' cad	1.69
R0123C	3/8-24 x 1/2" x 9/16"	chrome	2.81
R0123NI	3/8-24 x 1/2" x 9/16"	'm' Nickle	1.90
2633-30A	3/8-24 x 7/32" x 5/8"	'm' bare	2.00
R0125P	3/8-24 x 1/4" x 5/8"	'm' park	1.50
R2318-36AP	3/8-24 x 21/64" x 5/8"	'm' park	1.63
R2318-36A	3/8-24 x 21/64" x 5/8"	'm' cad	1.69
R2318-36AC	3/8-24 x 21/64" x 5/8"	'm' chrome	1.88
R0128P	3/8-24 x 9/16" castle	park	2.00
R0128	3/8-24 x 9/16" castle	cad	2.13
R0128C	3/8-24 x 9/16" castle	chrome	2.31
R0128NI	3/8-24 x 9/16" castle	Nickle	2.00
3910-37	3/8-24 x 15/16" castle	park	3.00
R3910-37P	3/8-24 x 15/16" castle	park	3.44
R3910-37	3/8-24 x 15/16" castle	cad	3.44
R3910-37C	3/8-24 x 15/16" castle	chrome	4.38
R7775P	3/8-24 x 9/16" flexloc	park	2.81
R7775	3/8-24 x 9/16" flexloc	cad	2.81
R0130P	7/16-18 x 1/4" x 11/16"	'm' park	1.63
R0130	7/16-18 x 1/4" x 11/16"	'm' cad	2.06
R0130NI	7/16-18 x 1/4" x 11/16"	'm' Nickle	1.80
R4166-28P	7/16-20 x 1/4" x 9/16"	'm' park	1.75
R4166-28	7/16-20 x 1/4" x 9/16"	'm' cad	1.88
R4166-28C	7/16-20 x 1/4" x 9/16"	'm' chrome	2.50
R0136P	7/16-20 x 1/4" x 5/8"	'm' park	1.63
R0136	7/16-20 x 1/4" x 5/8"	'm' cad	1.69
R0136C	7/16-20 x 1/4" x 5/8"	'm' chrome	1.75
R0133P	7/16-20 x 3/8" x 5/8"	'm' park	1.63
R0133	7/16-20 x 3/8" x 5/8"	'm' cad	1.69
R0133C	7/16-20 x 3/8" x 5/8"	'm' chrome	1.88
0134	7/16-20 x 1/2" x 5/8"	'm' park	2.00
R0134P	7/16-20 x 1/2" x 5/8"	'm' park	1.69
R0134	7/16-20 x 1/2" x 5/8"	'm' cad	1.81
R0134C	7/16-20 x 1/2" x 5/8"	'm' chrome	3.13
R0134NI	7/16-20 x 1/2" x 5/8"	'm' Nickle	2.50
0138	7/16-20 x 5/8" castle	cad	3.20
R7825P	7/16-20 x 5/8" flexlock	park	3.75
R7825	7/16-20 x 5/8" flexlock	cad	3.94
R7872	7/16-20 x 5/8" red cap		
R7872B	7/16-20 x 5/8" black cap		2.00
R7863	7/16-20 x 3/8" x 3/4"	'm' cad	
R7863C	7/16-20 x 3/8" x 3/4"	'm' chrome	2.25
R2644-30P	7/16-20 x 7/16" x 3/4"	'm' park	2.50
R2644-30	7/16-20 x 7/16" x 3/4"	'm' cad	2.50
R2644-30C	7/16-20 x 7/16" x 3/4"	'm' chrome	3.44
2641-30	7/16-20 x 9/32" x 13/16"	'm' park	2.00
2641-30C	7/16-20 x 9/32" x 13/16"	'm' chrome	3.00
R4079-26P	7/16-20 x 13/32" x 13/16"	'm' park	5.94
R4079-26	7/16-20 x 13/32" x 13/16"	'm' cad	5.94
0131	7/16-24 x 1/4" x 3/4"	'm' park	2.00
0135A	1/2-13 x 1/2" x 7/8"	zinc	
R2634-30AP	1/2-20 x 3/8" x 3/4"	'm' park	2.50
R2634-30A	1/2-20 x 3/8" x 3/4"	'm' cad	2.50
R2634-30AC	1/2-20 x 3/8" x 3/4"	'm' chrome	3.44

Nuts (continued)

R2634-36	1/2-20 x 3/4 acorn nut	park	5.00
R2634-36C	1/2-20 x 3/4 acorn nut	chrome	5.63
R2643-31	1/2-20 x 5/16" x 13/16" 'm'	park	2.13
R2643-31cad	1/2-20 x 5/16" x 13/16" 'm'	cad	2.19
R6032-36P	1/2-20 x 7/16" x 7/8" 'm'	park	2.25
7914	1/2-20 x 7/16" x 7/8"	zinc	4.00
7907	1/2-20 x 7/16" x 7/8" 'm'	bare	3.00
R4178-42P	1/2-20 x 7/8" castle nut	park	6.25
R4178-42	1/2-20 x 7/8" castle nut	cad	7.50
R4178-42C	1/2-20 x 7/8" castle nut	chrome	9.38
R7926	1/2-20 x 9/32" x 1-3/16" 'm'		
R6036-36BP	9/16-18 x 11/32" x 15/16" 'm'	park	3.13
R6036-36B	9/16-18 x 11/32" x 15/16" 'm'	cad	3.31
R3996-36P	5/8-18 x 7/16" x 7/8" 'm'	park	3.13
R3996-36	5/8-18 x 7/16" x 7/8" 'm'	cad	3.38
R3996-36C	5/8-18 x 7/16" x 7/8" 'm'	chrome	5.00
R7974P	5/8-18 x 7/32" x 15/16" 'm'	park	
R7974	5/8-18 x 7/32" x 15/16" 'm'	cad	3.13
364-29	5/8-18 x 7/32" x 15/16" 'm'		8.00
R364-29	5/8-18 x 7/32" x 15/16" 'm'		6.50
R2274-36	5/8-18 x 7/32" x 1" 'm'		3.25

Nuts (continued)

2050-12	5/8-18 x 5/16" x 1-1/16" 'm'	park	7.00
0142	5/8 -24 x 7/32" x 7/8" 'm'	park	3.00
R2050-30	11/16-18 x 1" special	'm' park	13.75
364-37	11/16-18 x 7/32" x 1-1/16" 'm'		4.00
R8011	11/16-18 x 7/32" x 1-3/16" 'm'		5.50
3929-44	11/16-24 x 15/16" special	'm' park	6.00
R3929-44P	11/16-24 x 15/16" special	'm' park	8.75
R3929-44	11/16-24 x 15/16" special	'm' cad	8.75
R3929-44C	11/16-24 x 15/16" special	'm' chrome	11.25
R8025	3/4-16 x 11/16" x 1-1/16" 'm'		8.75
2932-14	3/4-18 x 7/16" x 1-1/16" 'm'	park	6.00
R364-36	3/4-18 x 9/32" x 1-3/16" 'm'		8.50
R365-15	13/16-18 x 1/4" x 1-3/16" 'm'		11.56
R4005-35P	13/16-24 x 19/64" x 1-3/16" 'm'	park	13.75
R4005-35	13/16-24 x 19/64" x 1-3/16" 'm'	cad	13.75
R4005-35C	13/16-24 x 19/64" x 1-3/16" 'm'	chrome	15.94
R4184-30P	13/16-24 x 3/8" x 1-3/16" 'm'	park	7.50
R4184-30	13/16-24 x 3/8" x 1-3/16" 'm'	cad	8.13
R4184-30C	13/16-24 x 3/8" x 1-3/16" 'm'	chrome	10.00

Washers

Listed by size:

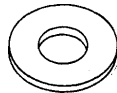

R6189W	5/32" x 25/64" x .032"	brass	0.35
R0202A	3/16" x 21/64" x 1/64"	zinc	0.40
R0201P	3/16" x 7/16" x 1/32"	park	0.31
R0201	3/16" x 7/16" x 1/32"	zinc	0.38
R0201A	13/64" x 3/8" x 1/32"	brass	0.50
R0205P	7/32" x 1/2" x 1/16"	park	0.38
0207	1/4" x 7/16" x 1/32"	park	1.00
R6099	1/4" x 7/16" x 1/16"	zinc	0.40
R6099C	1/4" x 7/16" x 1/16"	chrome	0.44
1417-42	1/4" x 1/2" x 1/16"		0.80
R0208AP	1/4" x 9/16" x 1/16"	park	0.38
R0207B	1/4" x 9/16" x 1/32"	zinc	0.30
R0208P	1/4" x 5/8" x 1/16"	park	0.38
R0208Z	1/4" x 5/8" x 1/16"	zinc	0.30
R0208C	1/4" x 5/8" x 1/16"	chrome	0.50
R0208NI	1/4" x 5/8" x 1/16"	Nickle	0.50
R0211P	9/32" x 15/32" x 1/32"	park	0.63
R0213P	5/16" x 1/2" x 3/32"	park	0.50
R0213NI	5/16" x 1/2" x 3/32"	Nickle	0.63
R0212P	5/16" x 9/16" x 1/32"	park	0.50
R0212	5/16" x 9/16" x 1/32"	stainless	0.30
R0212C	5/16" x 9/16" x 1/32"	chrome	
R6316WP	5/16" x 5/8" x 1/16"	park	0.31
R6316W	5/16" x 5/8" x 1/16"	cad/zinc	0.38
R6316WC	5/16" x 5/8" x 1/16"	chrome	0.50
R0214P	5/16" x 11/16" x 1/16"	park	0.50
R0214	5/16" x 11/16" x 1/16"	cad	0.50
R0214C	5/16" x 11/16" x 1/16"	chrome	0.65
6327B	5/16" x 3/4" x 1/16"	park	2.00
R6327B	5/16" x 3/4" x 1/16"	zinc	0.30
R0215P	5/16" x 15/16" x 1/16"	park	0.63
R0212AP	21/64" x 15/16" x 3/16"	park	1.13
R2788-30	3/8" x 9/16" x 1/16"	park	1.00
R6377	3/8" x 5/8" x 1/32"	brass	0.50
R0226P	3/8" x 5/8" x 3/64"	park	0.63
R0224AP	3/8" x 23/32" x 1/16"	park	0.63

Washers (continued)

R0224P	3/8" x 13/16" x 1/16"	park	0.63
R0224	3/8" x 13/16" x 1/16"	cad	0.63
R0224C	3/8" x 13/16" x 1/16"	chrome	0.88
R0224NI	3/8" x 13/16" x 1/16"	Nickle	0.70
R0225P	3/8" x 13/16" x 7/64"	park	0.63
R0223AP	3/8" x 7/8" x 1/8"	park	1.13
R0223A	3/8" x 7/8" x 1/8"	cad	1.13
R0223AC	3/8" x 7/8" x 1/8"	chrome	1.38
R0223P	3/8" x 1" x 1/8"	park	1.13
R0223	3/8" x 1" x 1/8"	cad	1.13
R0223C	3/8" x 1" x 1/8"	chrome	1.50
R13457-40P	3/8" x 1-1/8" x 1/8"	park	1.25
R13457-40cad	3/8" x 1-1/8" x 1/8"	cad	1.38
R13457-40C	3/8" x 1-1/8" x 1/8"	chrome	3.13
R0227AP	25/64" x 13/16" x 1/8"	park	0.75
3572-36C	13/32" x 5/8" x 13/32"	park	0.60
R3572-36C	13/32" x 5/8" x 13/32"	brass	0.50
2952-35	13/32" x 11/16" x 1/4"	park	2.50
0228	7/16" x 21/32" x 1/16"	park	1.50
R2242-36B	7/16" x 3/4" x 1/64"	zinc	0.50
R15-36P	7/16" x 3/4" x 1/8"	park	0.75
R15-36	7/16" x 3/4" x 1/8"	cad	0.75
R15-36C	7/16" x 3/4" x 1/8"	chrome	1.06
R0232P	7/16" x 13/16" x 3/32"	park	0.88
0232	7/16" x 13/16" x 3/32"	cad	1.50
R0232C	7/16" x 13/16" x 3/32"	chrome	1.25
0230	7/16" x 15/16" x 1/8"	park	2.00
R0230P	7/16" x 15/16" x 1/8"	park	1.06
R0230	7/16" x 15/16" x 1/8"	cad	1.06
R0230C	7/16" x 15/16" x 1/8"	chrome	1.25
R0234	29/64" x 1-1/8" x .015"		0.75
R0231P	29/64" x 1-1/8" x 3/32"	park	1.25
0231W	29/64" x 1-1/8" x 3/32"	cad	
R1643-29	15/32" x 3/4" x .033"		0.80
R1643-29S	15/32" x 3/4" x .070"		0.80
1643-30	15/32" x 3/4" x .072"	park	2.00
R13458-36P	1/2" x 1-1/8" x 3/32"	park	1.25
R13458-36cad	1/2" x 1-1/8" x 3/32"	cad	1.38
R13458-36C	1/2" x 1-1/8" x 3/32"	chrome	1.75
R6581	17/32" x 15/16" x .025"	brass	0.95

Screws, Bolts, Nuts

Lockwashers

Listed by size:



R0250	No.4 x 17/64" x 1/32"	zinc	0.20
R0251	No.6 x 15/64" x 1/32"	zinc	0.20
R0252P	No.8 x 5/32" x 1/32"	park	0.25
R0252	No.8 x 5/32" x 1/32"	zinc	0.20
R0252C	No.8 x 5/32" x 1/32"	chrome	0.38
R0254P	No.10 x 21/64" x 3/64"	park	0.25
R0254	No.10 x 21/64" x 3/64"	zinc	0.20
R0254C	No.10 x 21/64" x 3/64"	chrome	0.38
0253	3/16" x 3/8" x 3/64"	park	0.25
R0255P	No.12 x 11/32" x 3/64"	park	0.25
R0255	No.12 x 11/32" x 3/64"	zinc	0.20
0255A	7/32" x 15/32" x 3/64"	park	1.30
R0256P	1/4" x 1/2" x 1/16"	park	0.25
R0256	1/4" x 1/2" x 1/16"	zinc	0.25
R0256C	1/4" x 1/2" x 1/16"	chrome	0.38
R0259P	5/16" x 9/16" x 1/16"	park	0.25
R0259	5/16" x 9/16" x 1/16"	zinc	0.25
R0259C	5/16" x 9/16" x 1/16"	chrome	0.38
R0261B	3/8" x 5/8" x 3/32"	black	0.20
R0261P	3/8" x 5/8" x 3/32"	park	0.25
R0261	3/8" x 5/8" x 1/16"	zinc	0.25
R0261C	3/8" x 5/8" x 3/32"	chrome	0.38
R0262P	3/8" x 13/16" x 1/16"	park	4.38
R0265P	7/16" x 11/16" x 3/32"	park	0.69
R0265	7/16" x 11/16" x 3/32"	zinc	0.75
R0265C	7/16" x 11/16" x 3/32"	chrome	0.94
R0265AP	7/16" x 3/4" x 3/32"	park	1.06
R0265A	7/16" x 3/4" x 3/32"	zinc	0.30
R0265AC	7/16" x 3/4" x 3/32"	chrome	0.69
R0266P	7/16" x 3/4" x 1/8"	park	0.75
R0266	7/16" x 3/4" x 1/8"	cad	0.75
R0266C	7/16" x 3/4" x 1/8"	chrome	0.85
0266	7/16" x 13/16" x 3/32"	park	1.50
R0269P	9/16" x 15/16" x 3/32"	park	1.50
R0269	9/16" x 15/16" x 3/32"	zinc	0.30
R7043	3/4" x 1-1/4" x 3/16"	zinc	0.50

0253, 0255A, 0262, 0266 are special lockwashers (larger o.d.)

Special Lockwashers

Listed by size:

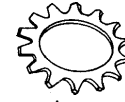
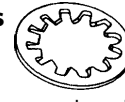

R7206W	No.4	external tooth	zinc	0.20
R0351	No.6	internal tooth	zinc	0.20
R7143	No.8	external tooth	zinc	0.30
R0352	No.8	internal tooth	zinc	0.20
R0353	No.8	external-internal	zinc	0.25
R0354	No.10	external tooth	zinc	0.20
R0356	No.10	internal tooth	zinc	0.20
R7121	No.12	internal tooth	zinc	0.20
R0359	1/4"	internal tooth	zinc	0.20
R0363P	1/4"	external tooth	park	0.38
R0363	1/4"	external tooth	zinc	0.20
R7229W	1/4"	external-internal	zinc	0.35
R0365P	1/4"	countersunk	park	0.38
R0365	1/4"	countersunk	zinc	0.25
R0360	5/16"	internal tooth	zinc	0.20
R7232	5/16"	external tooth	zinc	0.20
R0370P	5/16"	countersunk	park	0.50
R0370	5/16"	countersunk	zinc	0.30
R7042	5/16"	high collar	zinc	0.30
R0374	3/8"	internal tooth	zinc	0.20
R7145W	3/8"	external tooth	zinc	0.25
R6027W	3/8"	countersunk	zinc	0.35
R7045	3/8"	high collar	zinc	0.30
R0362	7/16"	internal tooth	zinc	0.20
R7129	1/2"	internal tooth	zinc	0.25
R0390	1/2"	external tooth	zinc	0.25
R7242	5/8"	external tooth	zinc	0.30
R7142	3/4"	internal tooth	zinc	0.30
R7144	3/4"	external tooth	zinc	0.30

Steel Balls



R1297-26	5/32" steel ball	0.35
R0279	3/16" steel ball	
R2472-41B	7/32" steel ball	0.20
R0280	1/4" steel ball	0.20
R0282	5/16" steel ball	0.30
R704-36	3/8" steel ball	0.40
R2251-36	1/2" steel ball	1.00

Grease Fittings



R0340	Alemite fitting	'24-'37	Nickle	3.75
R0344	Grease nipple	straight	zinc	2.63
R0344C	Grease nipple	straight	chrome	2.75
R0344P	Grease nipple	straight	park	2.63
0345	Grease nipple	67.5° angle	cad	3.00
R0347	Grease nipple	90° angle	zinc	2.00

Rivets



1647-31A	1/8" x 9/32"	brass	tubular	0.50
4046-31	9/64" x 9/32"	brass	tubular	0.30
R4033-35	5/32" x 1/2"	steel	round head	0.25
2485-41A	3/16" x 7/32"	brass	countersunk	0.20
R2485-41	3/16" x 9/32"	brass	countersunk	n.a.
2485-40	3/16" x 3/8"	brass	countersunk	0.20
0306	3/16" x 5/16"	steel	round head	0.50
R0308	3/16" x 9/16"	steel	round head	0.35
0314	3/16" x 3/8"	steel	truss head	1.00

Cotter Pins

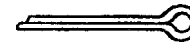

R551	3/64" x 9/16"	zinc	0.20
R0290P	1/16" x 1/2"	park	0.19
R0290	1/16" x 1/2"	zinc	0.15
R0296	1/16" x 5/8"	zinc	0.15
R0297	1/16" x 3/4"	zinc	0.15
R0291P	3/32" x 5/8"	park	0.19
R0291	3/32" x 5/8"	zinc	0.15
R0298	3/32" x 7/8"	zinc	0.15
513	3/32" x 15/16"	zinc	0.60
R0292P	3/32" x 1"	park	0.25
R0292	3/32" x 1"	zinc	0.15
R0293	1/8" x 5/8"	zinc	0.15
R0294	1/8" x 1-1/4"	zinc	0.20
R511	9/64" x 1-1/4"	zinc	0.25
R0295	3/16" x 1"	zinc	0.25



Round head machine screw, zinc

H01044005	4-40 x 1/4"	0.30
H01044007	4-40 x 3/8"	0.30
H01044010	4-40 x 1/2"	0.30
H01044012	4-40 x 5/8"	0.30
H01044015	4-40 x 3/4"	0.30
H01054005	5-40 x 1/4"	0.30
H01054010	5-40 x 1/2"	0.30
H01063205	6-32 x 1/4"	0.30
H01063207	6-32 x 3/8"	0.30
H01063210	6-32 x 1/2"	0.30
H01063212	6-32 x 5/8"	0.30
H01063215	6-32 x 3/4"	0.30
H01063220	6-32 x 1"	0.30
H01063225	6-32 x 1 1/4"	0.30
H01063230	6-32 x 1 1/2"	0.30
H01083205	8-32 x 1/4"	0.30
H01083207	8-32 x 3/8"	0.30
H01083210	8-32 x 1/2"	0.30
H01083212	8-32 x 5/8"	0.30
H01083215	8-32 x 3/4"	0.30
H01083217	8-32 x 7/8"	0.30
H01083220	8-32 x 1"	0.50
H01083225	8-32 x 1 1/4"	0.50
H01083230	8-32 x 1 1/2"	0.50
H01102407	10-24 x 3/8"	0.30
H01102410	10-24 x 1/2"	0.30
H01102412	10-24 x 5/8"	0.30
H01102415	10-24 x 3/4"	0.30
H01102420	10-24 x 1"	0.50
H01102425	10-24 x 1 1/4"	0.50
H01102430	10-24 x 1 1/2"	0.50
H01102435	10-24 x 1 3/4"	0.50
H01102440	10-24 x 2"	0.50
H01103207	10-32 x 3/8"	0.30
H01103210	10-32 x 1/2"	0.30
H01103212	10-32 x 5/8"	0.30
H01103215	10-32 x 3/4"	0.30
H01103220	10-32 x 1"	0.50
H01103225	10-32 x 1 1/4"	0.50
H01103230	10-32 x 1 1/2"	0.50
H01103235	10-32 x 1 3/4"	0.50
H01103240	10-32 x 2"	0.50
H01122407	12-24 x 3/8"	0.30
H01122410	12-24 x 1/2"	0.30
H01122412	12-24 x 5/8"	0.30
H01122415	12-24 x 3/4"	0.30
H01122420	12-24 x 1"	0.50

Flat head machine screw, zinc

H02044007	4-40 x 3/8"	0.30
H02044010	4-40 x 1/2"	0.30
H02044012	4-40 x 5/8"	0.30
H02044015	4-40 x 3/4"	0.30
H02063207	6-32 x 3/8"	0.30
H02063210	6-32 x 1/2"	0.30
H02063212	6-32 x 5/8"	0.30
H02063215	6-32 x 3/4"	0.30
H02063220	6-32 x 1"	0.30
H02083207	8-32 x 3/8"	0.30
H02083210	8-32 x 1/2"	0.30
H02083212	8-32 x 5/8"	0.30
H02083215	8-32 x 3/4"	0.30
H02083220	8-32 x 1"	0.30
H02102410	10-24 x 1/2"	0.30
H02102412	10-24 x 5/8"	0.30
H02102415	10-24 x 3/4"	0.30
H02102420	10-24 x 1"	0.30
H02102425	10-24 x 1 1/4"	0.30
H02103210	10-32 x 1/2"	0.30
H02103212	10-32 x 5/8"	0.30
H02103215	10-32 x 3/4"	0.30
H02103220	10-32 x 1"	0.30
H02103225	10-32 x 1 1/4"	0.30

Flat head sheet metal screws, zinc

H03040007	4 x 3/8"	0.30
H03040010	4 x 1/2"	0.30
H03040012	4 x 5/8"	0.30
H03060007	6 x 3/8"	0.30
H03060010	6 x 1/2"	0.30
H03060012	6 x 5/8"	0.30
H03060015	6 x 3/4"	0.30
H03060020	6 x 1"	0.30
H03080007	8 x 3/8"	0.30
H03080010	8 x 1/2"	0.30
H03080012	8 x 5/8"	0.30
H03080015	8 x 3/4"	0.30
H03080020	8 x 1"	0.30
H03100010	10 x 1/2"	0.30
H03100015	10 x 3/4"	0.30
H03100020	10 x 1"	0.30
H03100025	10 x 1 1/4"	0.30
H03120010	12 x 1/2"	0.30
H03120015	12 x 3/4"	0.30
H03120020	12 x 1"	0.30
H03140010	14 x 1/2"	0.30
H03140015	14 x 3/4"	0.30
H03140020	14 x 1"	0.30



Pan head sheet metal screws, zinc

H04040007	4 x 3/8"	0.30
H04040010	4 x 1/2"	0.30
H04040012	4 x 5/8"	0.30
H04060007	6 x 3/8"	0.30
H04060010	6 x 1/2"	0.30
H04060012	6 x 5/8"	0.30
H04060015	6 x 3/4"	0.30
H04060020	6 x 1"	0.30
H04080007	8 x 3/8"	0.30
H04080010	8 x 1/2"	0.30
H04080012	8 x 5/8"	0.30
H04080015	8 x 3/4"	0.30
H04080020	8 x 1"	0.30
H04100010	10 x 1/2"	0.30
H04100012	10 x 5/8"	0.30
H04100015	10 x 3/4"	0.30
H04100020	10 x 1"	0.30
H04100025	10 x 1 1/4"	0.30
H04120010	12 x 1/2"	0.30
H04120015	12 x 3/4"	0.30
H04120020	12 x 1"	0.30
H04140010	14 x 1/2"	0.30
H04140015	14 x 3/4"	0.30
H04140020	14 x 1"	0.30



Hex head bolt, stainless steel

H06142012	1/4-20 x 5/8"	1.50
H06142015	1/4-20 x 3/4"	1.50
H06142017	1/4-20 x 7/8"	1.50
H06142020	1/4-20 x 1"	1.50
H06142025	1/4-20 x 1-1/4"	1.70
H06142030	1/4-20 x 1-1/2"	1.70
H06142035	1/4-20 x 1-3/4"	1.70
H06142040	1/4-20 x 2"	1.70
H06142045	1/4-20 x 2-1/4"	1.70
H06142812	1/4-28 x 5/8"	1.50
H06142815	1/4-28 x 3/4"	1.50
H06142817	1/4-28 x 7/8"	1.50
H06142820	1/4-28 x 1"	1.50
H06142825	1/4-28 x 1-1/4"	1.70
H06142830	1/4-28 x 1-1/2"	1.70
H06142835	1/4-28 x 1-3/4"	1.70
H06142840	1/4-28 x 2"	1.70

H06142845	1/4-28 x 2-1/4"	1.70
H06161812	5/16-18 x 5/8"	1.50
H06161815	5/16-18 x 3/4"	1.50
H06161817	5/16-18 x 7/8"	1.50
H06161820	5/16-18 x 1"	1.50
H06161825	5/16-18 x 1-1/4"	1.70
H06161830	5/16-18 x 1-1/2"	1.70
H06161835	5/16-18 x 1-3/4"	1.70
H06161840	5/16-18 x 2"	1.70
H06161845	5/16-18 x 2-1/4"	1.70
H06162412	5/16-24 x 5/8"	1.50
H06162415	5/16-24 x 3/4"	1.50
H06162417	5/16-24 x 7/8"	1.50
H06162420	5/16-24 x 1"	1.50
H06162425	5/16-24 x 1-1/4"	1.70
H06162430	5/16-24 x 1-1/2"	1.70
H06162435	5/16-24 x 1-3/4"	1.70

H06162440	5/16-24 x 2"	1.70
H06162445	5/16-24 x 2-1/4"	1.70
H06181615	3/8-16 x 3/4"	1.50
H06181620	3/8-16 x 1"	1.50
H06181625	3/8-16 x 1-1/4"	1.70
H06181630	3/8-16 x 1-1/2"	1.70
H06181635	3/8-16 x 1-3/4"	1.70
H06181640	3/8-16 x 2"	1.70
H06182415	3/8-24 x 3/4"	1.50
H06182420	3/8-24 x 1"	1.50
H06182425	3/8-24 x 1-1/4"	1.70
H06182430	3/8-24 x 1-1/2"	1.70
H06182435	3/8-24 x 1-3/4"	1.70
H06182440	3/8-24 x 2"	1.70



Standard Hardware

Hex head bolt, zinc

H07142010	1/4-20 x 1/2"	0.50	H07162417	5/16-24 x 7/8"	0.50	H07182470	3/8-24 x 3-1/2"	0.80
H07142012	1/4-20 x 5/8"	0.50	H07162420	5/16-24 x 1"	0.50	H07182475	3/8-24 x 3-3/4"	0.80
H07142015	1/4-20 x 3/4"	0.50	H07162425	5/16-24 x 1-1/4"	0.50	H07201415	7/16-14 x 3/4"	1.30
H07142017	1/4-20 x 7/8"	0.50	H07162430	5/16-24 x 1-1/2"	0.50	H07201420	7/16-14 x 1"	1.30
H07142020	1/4-20 x 1"	0.50	H07162435	5/16-24 x 1-3/4"	0.70	H07201425	7/16-14 x 1-1/4"	1.30
H07142025	1/4-20 x 1-1/4"	0.50	H07162440	5/16-24 x 2"	0.70	H07201430	7/16-14 x 1-1/2"	1.30
H07142030	1/4-20 x 1-1/2"	0.50	H07162445	5/16-24 x 2-1/4"	0.70	H07201435	7/16-14 x 1-3/4"	1.60
H07142035	1/4-20 x 1-3/4"	0.70	H07162450	5/16-24 x 2-1/2"	0.70	H07201440	7/16-14 x 2"	1.60
H07142040	1/4-20 x 2"	0.70	H07162455	5/16-24 x 2-3/4"	0.70	H07201445	7/16-14 x 2-1/4"	1.60
H07142045	1/4-20 x 2-1/4"	0.70	H07181610	3/8-16 x 1/2"	0.70	H07201450	7/16-14 x 2-1/2"	1.60
H07142050	1/4-20 x 2-1/2"	0.70	H07181612	3/8-16 x 5/8"	0.70	H07201455	7/16-14 x 2-3/4"	1.60
H07142055	1/4-20 x 2-3/4"	0.70	H07181615	3/8-16 x 3/4"	0.70	H07202015	7/16-20 x 3/4"	1.30
H07142810	1/4-28 x 1/2"	0.50	H07181617	3/8-16 x 7/8"	0.70	H07202020	7/16-20 x 1"	1.30
H07142812	1/4-28 x 5/8"	0.50	H07181620	3/8-16 x 1"	0.80	H07202025	7/16-20 x 1-1/4"	1.30
H07142815	1/4-28 x 3/4"	0.50	H07181625	3/8-16 x 1-1/4"	0.80	H07202030	7/16-20 x 1-1/2"	1.30
H07142817	1/4-28 x 7/8"	0.50	H07181630	3/8-16 x 1-1/2"	0.80	H07202035	7/16-20 x 1-3/4"	1.60
H07142820	1/4-28 x 1"	0.50	H07181635	3/8-16 x 1-3/4"	0.80	H07202040	7/16-20 x 2"	1.60
H07142825	1/4-28 x 1-1/4"	0.50	H07181640	3/8-16 x 2"	0.80	H07202045	7/16-20 x 2-1/4"	1.60
H07142830	1/4-28 x 1-1/2"	0.50	H07181645	3/8-16 x 2-1/4"	0.80	H07202050	7/16-20 x 2-1/2"	1.60
H07142835	1/4-28 x 1-3/4"	0.70	H07181650	3/8-16 x 2-1/2"	0.80	H07202055	7/16-20 x 2-3/4"	1.60
H07142840	1/4-28 x 2"	0.70	H07181655	3/8-16 x 2-3/4"	0.80	H07202060	7/16-20 x 3"	1.60
H07142845	1/4-28 x 2-1/4"	0.70	H07181660	3/8-16 x 3"	0.80	H07221315	1/2-13 x 3/4"	1.30
H07142850	1/4-28 x 2-1/2"	0.70	H07181665	3/8-16 x 3-1/4"	0.80	H07221320	1/2-13 x 1"	1.30
H07142855	1/4-28 x 2-3/4"	0.70	H07181670	3/8-16 x 3-1/2"	0.80	H07221325	1/2-13 x 1-1/4"	1.30
H07161812	5/16-18 x 5/8"	0.50	H07181675	3/8-16 x 3-3/4"	0.80	H07221330	1/2-13 x 1-1/2"	1.30
H07161815	5/16-18 x 3/4"	0.50	H07182410	3/8-24 x 1/2"	0.70	H07221335	1/2-13 x 1-3/4"	1.60
H07161817	5/16-18 x 7/8"	0.50	H07182412	3/8-24 x 5/8"	0.70	H07221340	1/2-13 x 2"	1.60
H07161820	5/16-18 x 1"	0.50	H07182415	3/8-24 x 3/4"	0.70	H07221345	1/2-13 x 2-1/4"	1.60
H07161825	5/16-18 x 1-1/4"	0.50	H07182417	3/8-24 x 7/8"	0.70	H07221350	1/2-13 x 2-1/2"	1.60
H07161830	5/16-18 x 1-1/2"	0.50	H07182420	3/8-24 x 1"	0.80	H07221355	1/2-13 x 2-3/4"	1.60
H07161835	5/16-18 x 1-3/4"	0.70	H07182425	3/8-24 x 1-1/4"	0.80	H07221360	1/2-13 x 3"	1.60
H07161840	5/16-18 x 2"	0.70	H07182430	3/8-24 x 1-1/2"	0.80	H07221365	1/2-13 x 3-1/4"	1.60
H07161845	5/16-18 x 2-1/4"	0.70	H07182435	3/8-24 x 1-3/4"	0.80	H07222020	1/2-20 x 1"	1.30
H07161850	5/16-18 x 2-1/2"	0.70	H07182440	3/8-24 x 2"	0.80	H07222025	1/2-20 x 1-1/4"	1.30
H07161855	5/16-18 x 2-3/4"	0.70	H07182445	3/8-24 x 2-1/4"	0.80	H07222030	1/2-20 x 1-1/2"	1.30
H07161860	5/16-18 x 3"	0.70	H07182450	3/8-24 x 2-1/2"	0.80	H07222035	1/2-20 x 1-3/4"	1.60
H07162410	5/16-24 x 1/2"	0.50	H07182455	3/8-24 x 2-3/4"	0.80	H07222040	1/2-20 x 2"	1.60
H07162412	5/16-24 x 5/8"	0.50	H07182460	3/8-24 x 3"	0.80	H07222045	1/2-20 x 2 1/4"	1.60
H07162415	5/16-24 x 3/4"	0.50	H07182465	3/8-24 x 3-1/4"	0.80	H07222050	1/2-20 x 2 1/2"	1.60
						H07222055	1/2-20 x 2 3/4"	1.60
						H07222060	1/2-20 x 3"	1.60

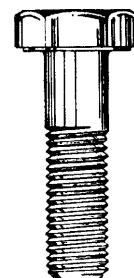

Hex head bolt, chrome plated

H05142012	1/4-20 x 5/8"	1.70	H05161845	5/16-18 x 2 1/4"	2.00	H05201430	7/16-14 x 1-1/2"	2.20
H05142015	1/4-20 x 3/4"	1.70	H05162410	5/16-24 x 1/2"	1.70	H05201435	7/16-14 x 1-3/4"	2.20
H05142017	1/4-20 x 7/8"	1.70	H05162412	5/16-24 x 5/8"	1.70	H05201440	7/16-14 x 2"	2.20
H05142020	1/4-20 x 1"	1.70	H05162415	5/16-24 x 3/4"	1.70	H05202020	7/16-20 x 1"	2.00
H05142025	1/4-20 x 1-1/4"	2.00	H05162417	5/16-24 x 7/8"	1.70	H05202025	7/16-20 x 1-1/4"	2.00
H05142030	1/4-20 x 1-1/2"	2.00	H05162420	5/16-24 x 1"	1.70	H05202030	7/16-20 x 1-1/2"	2.20
H05142035	1/4-20 x 1-3/4"	2.00	H05162425	5/16-24 x 1-1/4"	2.00	H05202035	7/16-20 x 1-3/4"	2.20
H05142040	1/4-20 x 2"	2.00	H05162430	5/16-24 x 1-1/2"	2.00	H05202040	7/16-20 x 2"	2.20
H05142045	1/4-20 x 2-1/4"	2.00	H05162435	5/16-24 x 1-3/4"	2.00	H05221315	1/2-13 x 3/4"	2.00
H05142812	1/4-28 x 5/8"	1.70	H05162440	5/16-24 x 2"	2.00	H05221325	1/2-13 x 1-1/4"	2.00
H05142815	1/4-28 x 3/4"	1.70	H05162445	5/16-24 x 2-1/4"	2.00	H05221330	1/2-13 x 1-1/2"	2.20
H05142817	1/4-28 x 7/8"	1.70	H05181615	3/8-16 x 3/4"	1.70	H05221340	1/2-13 x 2"	2.20
H05142820	1/4-28 x 1"	1.70	H05181620	3/8-16 x 1"	1.70	H05221345	1/2-13 x 2-1/4"	2.20
H05142825	1/4-28 x 1-1/4"	2.00	H05181625	3/8-16 x 1-1/4"	2.00	H05221350	1/2-13 x 2-1/2"	2.20
H05142830	1/4-28 x 1-1/2"	2.00	H05181630	3/8-16 x 1-1/2"	2.00	H05221355	1/2-13 x 2-3/4"	2.20
H05142835	1/4-28 x 1-3/4"	2.00	H05181635	3/8-16 x 1-3/4"	2.00	H05222020	1/2-20 x 1"	2.00
H05142840	1/4-28 x 2"	2.00	H05181640	3/8-16 x 2"	2.00	H05222030	1/2-20 x 1-1/2"	2.20
H05142845	1/4-28 x 2-1/4"	2.00	H05182415	3/8-24 x 3/4"	1.70	H05222035	1/2-20 x 1-3/4"	2.20
H05161812	5/16-18 x 5/8"	1.70	H05182420	3/8-24 x 1"	1.70	H05222040	1/2-20 x 2"	2.20
H05161815	5/16-18 x 3/4"	1.70	H05182425	3/8-24 x 1-1/4"	2.00	H05222045	1/2-20 x 2-1/4"	2.20
H05161817	5/16-18 x 7/8"	1.70	H05182430	3/8-24 x 1-1/2"	2.00	H05222050	1/2-20 x 2-1/2"	2.20
H05161820	5/16-18 x 1"	1.70	H05182435	3/8-24 x 1-3/4"	2.00	H05222055	1/2-20 x 2-3/4"	2.20
H05161825	5/16-18 x 1-1/4"	2.00	H05182440	3/8-24 x 2"	2.00			
H05161830	5/16-18 x 1-1/2"	2.00	H05201420	7/16-14 x 1"	2.00			
H05161835	5/16-18 x 1-3/4"	2.00	H05201425	7/16-14 x 1-1/4"	2.00			
H05161840	5/16-18 x 2"	2.00						

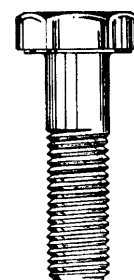

Hex nut, zinc			Hex nuts, chrome			Hex nuts, stainless steel		
H20044005	4-40 x 1/4"	0.20	H24142008	1/4-20 x 7/16"	0.75	H21063206	6-32 x 5/16"	0.50
H20063206	6-32 x 5/16"	0.20	H24142808	1/4-28 x 7/16"	0.75	H21083206	8-32 x 11/32"	0.50
H20083206	8-32 x 11/32"	0.20	H24161810	5/16-18 x 1/2"	0.88	H21102407	10-24 x 3/8"	0.50
H20102407	10-24 x 3/8"	0.20	H24162410	5/16-24 x 1/2"	0.88	H21103207	10-32 x 3/8"	0.50
H20103207	10-32 x 3/8"	0.20	H24181611	3/8-16 x 9/16"	1.00	H21142008	1/4-20 x 7/16"	0.50
H20122408	12-24 x 7/16"	0.20	H24182411	3/8-24 x 9/16"	1.00	H21142808	1/4-28 x 7/16"	0.50
H20142008	1/4-20 x 7/16"	0.20	H24201412	7/16-14 x 5/8"	1.00	H21161810	5/16-18 x 1/2"	0.50
H20142808	1/4-28 x 7/16"	0.20	H24202012	7/16-20 x 5/8"	1.00	H21162410	5/16-24 x 1/2"	0.50
H20161810	5/16-18 x 1/2"	0.20	H24222015	1/2-20 x 3/4"	1.25	H21181611	3/8-16 x 9/16"	0.60
H20162410	5/16-24 x 1/2"	0.20	H24261818	5/8-18 x 15/16"	1.50	H21182411	3/8-24 x 9/16"	0.60
H20181611	3/8-16 x 9/16"	0.30				H21202014	7/16-20 x 11/16"	0.60
H20182411	3/8-24 x 9/16"	0.30				H21222015	1/2-20 x 3/4"	1.00
H20201414	7/16-14 x 11/16"	0.30				H21261818	5/8-18 x 15/16"	2.00
H20202014	7/16-20 x 11/16"	0.30						
H20221315	1/2-13 x 3/4"	0.30						
H20222015	1/2-20 x 3/4"	0.30						
H20261118	5/8-11 x 15/16"	0.30						
H20261818	5/8-18 x 15/16"	0.30						
H20301022	3/4-10 x 1 1/8"	0.30						
H20301622	3/4-16 x 1 1/8"	0.30						





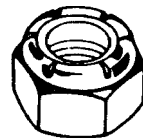

Nylock nuts, zinc			Nylock nuts, chrome		
H22044005	4-40 x 1/4"	0.30	H23102407	10-24 x 3/8"	0.88
H22063206	6-32 x 5/16"	0.30	H23103207	10-32 x 3/8"	0.88
H22083206	8-32 x 11/32"	0.30	H23142008	1/4-20 x 7/16"	1.00
H22102407	10-24 x 3/8"	0.30	H23142808	1/4-28 x 7/16"	0.88
H22103207	10-32 x 3/8"	0.30	H23161810	5/16-18 x 1/2"	1.00
H22122408	12-24 x 7/16"	0.30	H23162410	5/16-24 x 1/2"	1.00
H22142008	1/4-20 x 7/16"	0.30	H23181611	3/8-16 x 9/16"	1.13
H22142808	1/4-28 x 7/16"	0.30	H23182411	3/8-24 x 9/16"	1.13
H22161810	5/16-18 x 1/2"	0.30	H23201412	7/16-14 x 5/8"	1.13
H22162410	5/16-24 x 1/2"	0.40	H23202012	7/16-20 x 5/8"	1.13
H22181611	3/8-16 x 9/16"	0.40	H23222015	1/2-20 x 3/4"	1.25
H22182411	3/8-24 x 9/16"	0.40	H23261818	5/8-18 x 15/16"	1.38
H22201412	7/16-14 x 5/8"	0.40			
H22202012	7/16-20 x 5/8"	0.40			
H22221315	1/2-13 x 3/4"	0.40			
H22222015	1/2-20 x 3/4"	0.40			
H22261118	5/8-11 x 15/16"	0.40			
H22261818	5/8-18 x 15/16"	0.40			
H22301021	3/4-10 x 1 1/16"	0.40			
H22301621	3/4-16 x 1 1/16"	0.40			



Acorn nuts, chrome			Cap nuts, chrome		
H25102407	10-24 x 3/8"	1.63	H26102407	10-24 x 3/8"	1.88
H25103207	10-32 x 3/8"	1.63	H26103207	10-32 x 3/8"	1.88
H25142008	1/4-20 x 7/16"	1.88	H26142008	1/4-20 x 7/16"	1.88
H25142408	1/4-24 x 7/16"	1.88	H26142408	1/4-24 x 7/16"	1.88
H25142808	1/4-28 x 7/16"	1.63	H26142808	1/4-28 x 7/16"	1.63
H25161810	5/16-18 x 1/2"	1.88	H26161810	5/16-18 x 1/2"	1.88
H25162410	5/16-24 x 1/2"	1.88	H26162410	5/16-24 x 1/2"	1.88
H25181611	3/8-16 x 9/16"	2.00	H26181611	3/8-16 x 9/16"	2.13
H25182411	3/8-24 x 9/16"	2.00	H26182411	3/8-24 x 9/16"	2.13
H25201414	7/16-14 x 11/16"	2.50	H26201414	7/16-14 x 11/16"	2.50
H25202014	7/16-20 x 11/16"	2.50	H26202014	7/16-20 x 11/16"	2.50
H25221315	1/2-13 x 3/4"	3.75	H26221315	1/2-13 x 3/4"	3.75
H25222015	1/2-20 x 3/4"	3.75	H26222015	1/2-20 x 3/4"	3.75
H25241217	9/16-12 x 7/8"	4.00	H26241217	9/16-12 x 7/8"	4.00
H25241817	9/16-18 x 7/8"	4.00	H26241817	9/16-18 x 7/8"	4.00
H25261118	5/8-11 x 15/16"	5.63	H26261118	5/8-11 x 15/16"	5.63
H25261125	5/8-11 x 1 1/4"	8.13	H26261818	5/8-18 x 15/16"	5.63
H25261818	5/8-18 x 15/16"	6.88			
H25261825	5/8-18 x 1 1/4"	9.63			
H25301622	3/4-16 x 1 1/8"	7.75			

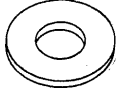
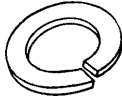

Standard Hardware

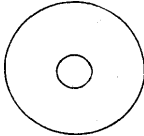
Standard flatwasher, zinc			Standard flatwasher, chrome			Flatwasher, stainless steel		
H40042002	4 x 5/16" x 1/32"	0.20	H41082802	8 x 7/16" x 1/32"	0.30	H45082402	8 x 3/8" x 1/32"	0.30
H40062403	6 x 3/8" x 3/64"	0.20	H41103202	10 x 1/2" x 1/32"	0.30	H45102803	10 x 7/16" x 3/64"	0.30
H40082804	8 x 7/16" x 1/16"	0.20	H41123604	12 x 9/16" x 1/16"	0.30	H45144004	1/4" x 5/8" x 1/16"	0.30
H40103203	10 x 1/2" x 3/64"	0.20	H41143603	1/4" x 9/16" x 3/64"	0.38	H45164404	5/16" x 11/16" x 1/16"	0.30
H40123604	12 x 9/16" x 1/16"	0.20	H41164004	5/16" x 5/8" x 1/16"	0.38	H45185204	3/8" x 13/16" x 1/16"	0.30
H40144004	1/4" x 5/8" x 1/16"	0.20	H41184804	3/8" x 3/4" x 1/16"	0.38	H45206004	7/16" x 15/16" x 1/16"	0.30
H40164404	5/16" x 11/16" x 1/16"	0.20	H41244806	7/16" x 3/4" x 3/32"	0.38	H45226804	1/2" x 1-1/16" x 1/16"	0.30
H40185204	3/8" x 13/16" x 1/16"	0.20				H45268404	5/8" x 1-5/16" x 1/16"	0.30
H40206005	7/16" x 15/16" x 5/64"	0.20						
H40226805	1/2" x 1-1/16" x 5/64"	0.20						
Standard lockwasher, zinc			Standard lockwasher, chrome			Lockwasher, stainless steel		
H50041202	4 x 3/16" x 1/32"	0.20	H53081803	8 x 9/32" x 3/64"	0.30	H55081802	8 x 9/32" x 1/32"	0.30
H50061602	6 x 1/4" x 1/32"	0.20	H53102003	10 x 5/16" x 3/64"	0.30	H55102003	10 x 5/16" x 3/64"	0.30
H50081803	8 x 9/32" x 3/64"	0.20	H53143004	1/4" x 15/32" x 1/16"	0.30	H55143004	1/4" x 15/32" x 1/16"	0.30
H50102103	10 x 21/64" x 3/64"	0.20	H53163605	5/16" x 9/16" x 5/64"	0.30	H55163605	5/16" x 9/16" x 5/64"	0.30
H50122404	12 x 3/8" x 1/16"	0.20	H53184306	3/8" x 43/64" x 3/32"	0.30	H55184406	3/8" x 11/16" x 3/32"	0.30
H50143104	1/4" x 31/64" x 1/16"	0.20	H53204807	7/16" x 3/4" x 7/64"	0.30	H55204807	7/16" x 3/4" x 7/64"	0.30
H50163605	5/16" x 9/16" x 5/64"	0.20	H53225508	1/2" x 55/64" x 1/8"	0.30	H55225408	1/2" x 27/32" x 1/8"	0.30
H50184307	3/8" x 43/64" x 7/64"	0.20	H53266710	5/8" x 1-3/64" x 5/32"	0.30	H55266709	5/8" x 1-3/64" x 9/64"	0.30
H50204908	7/16" x 49/64" x 1/8"	0.20						
H50225509	1/2" x 55/64" x 9/64"	0.20						
H50246008	9/16" x 15/16" x 1/8"	n.a.						
H50266710	5/8" x 1-3/64" x 5/32"	0.20						
H50308012	3/4" x 1-1/4" x 3/16"	0.20						
External lockwasher, zinc			Internal lockwasher, zinc					
H51040000	# 4	0.20	H52040000	# 4	0.20			
H51060000	# 6	0.20	H52060000	# 6	0.20			
H51080000	# 8	0.20	H52080000	# 8	0.20			
H51100000	#10	0.20	H52100000	#10	0.20			
H51120000	#12	0.20	H52120000	#12	0.20			
H51140000	1/4"	0.20	H52140000	1/4"	0.20			
H51160000	5/16"	0.20	H52160000	5/16"	0.20			
H51180000	3/8"	0.20	H52180000	3/8"	0.20			
H51200000	7/16"	0.20	H52200000	7/16"	0.20			
			H52220000	1/2"	0.20			
			H52260000	5/8"	0.20			
			H52280000	11/16"	0.20			
			H52300000	3/4"	0.20			
AN flatwasher (small O.D.), zinc			Hardened flatwasher, chrome			Fender washer (large O.D.), zinc		
H42062002	6 x 5/16" x 1/32"	0.20	H46143906	1/4" x 39/64" x 3/32"	0.80	H44106404	10 x 1" x 1/16"	0.20
H42082402	8 x 3/8" x 1/32"	0.20	H46164306	5/16" x 43/64" x 3/32"	0.80	H44146404	1/4" x 1" x 1/16"	0.20
H42102804	10 x 7/16" x 1/16"	0.20	H46185106	3/8" x 51/64" x 3/32"	0.80	H44169604	5/16" x 1-1/2" x 1/16"	0.20
H42143204	1/4" x 1/2" x 1/16"	0.20	H46205806	7/16" x 29/32" x 3/32"	0.80	H44189604	3/8" x 1-1/2" x 1/16"	0.20
H42163604	5/16" x 9/16" x 1/16"	0.20	H46226708	1/2" x 1-3/64" x 1/8"	0.80			
H42184004	3/8" x 5/8" x 1/16"	0.20	H46267308	5/8" x 1-9/64" x 1/8"	0.80			
H42204804	7/16" x 3/4" x 1/16"	0.20						
H42225604	1/2" x 7/8" x 1/16"	0.20						
H42267604	5/8" x 1-3/16" x 1/16"	0.20						

